

**COMMUNICATIONS
ALLIANCE LTD**



INDUSTRY GUIDELINE
ACIF G602.2:2007
LOCAL NUMBER PORTABILITY
IT SPECIFICATIONS AND OPERATIONS MANUAL
PART 2 – CATEGORY A PROCESSING

**ACIF G602.2:2007 Local Number Portability IT
Specifications and Operations Manual Part 2 – Category A
Processing Industry Guideline**

First published as ACIF G602.2:2003

Second edition as ACIF G602.2:2005

Third edition as ACIF G602.2:2006

Fourth edition as ACIF G602.2:2007

Communications Alliance Ltd was formed in 2006 to provide a unified voice for the Australian communications industry and to lead it into the next generation of converging networks, technologies and services. ACIF is a division of Communications Alliance.

Disclaimers

1. Notwithstanding anything contained in this Industry Guideline:
 - (a) ACIF disclaims responsibility (including where ACIF or any of its officers, employees, agents or contractors has been negligent) for any direct or indirect loss, damage, claim, or liability any person may incur as a result of any:
 - (i) reliance on or compliance with this Industry Guideline;
 - (ii) inaccuracy or inappropriateness of this Industry Guideline; or
 - (iii) inconsistency of this Industry Guideline with any law; and
 - (b) ACIF disclaims responsibility (including where ACIF or any of its officers, employees, agents or contractors has been negligent) for ensuring compliance by any person with this Industry Guideline.
2. The above disclaimers will not apply to the extent they are inconsistent with any relevant legislation.

Copyright

© Australian Communications Industry Forum Limited 2007

This document is copyright and must not be used except as permitted below or under the *Copyright Act 1968*. You may reproduce and publish this document in whole or in part for your or your organisation's own personal or internal compliance, educational or non-commercial purposes. You must not alter or amend this document in any way. You must not reproduce or publish this document for commercial gain without the prior written consent of ACIF. Organisations wishing to reproduce or publish this document for commercial gain (i.e. for distribution to subscribers to an information service) may apply to subscribe to the *ACIF Publications Subscription Service* by contacting the ACIF Business Manager at acif@acif.org.au. If you publish any part of this document for any purpose, you must also publish this copyright notice as part of that publication.

PARTICIPANTS

The Working Committee that revised this Guideline consisted of the following organisations and their representatives:

Organisation	Membership	Representative
ACMA	Non-voting	Gerry O'Reilly
ACMA	Non-voting	Helen Papazoglou
ACCC	Non-voting	Grant Young
Agile	Voting	Pia Bentick
iinet	Voting	Chris Watt
Optus	Voting	Mike North
PowerTel	Voting	Russell Symons
Primus Telecoms	Voting	Nigel Lee
Telstra	Voting	Jim Coburn
Telstra	Non-Voting	Craig McAinsh
TransAct	Voting	Leanne Layton

This Working Committee was chaired by Alexander R Osborne. James Duck of ACIF provided project management support.

TABLE OF CONTENTS

1	CAT. A - CONTEXT DIAGRAMS	3
	1.1 Cat. A – Donor as Losing C/CSP	3
	1.2 Cat. A - Donor as Gaining C/CSP	4
	1.3 Cat. A - Third Party	4
2	CAT. A – EVENT TREE DIAGRAMS	5
	2.1 Cat. A - Donor as Losing C/CSP	5
	2.2 Cat. A - Donor as Gaining C/CSP	6
	2.3 Cat. A – Third Party	7
3	CAT. A – LIFETIME OF PORT	8
	3.1 Cat. A - Donor as Losing C/CSP	8
	3.2 Cat. A - Donor as Gaining C/CSP	9
	3.3 Cat. A – Third Party	10
4	CAT. A -PROCESS FLOW DIAGRAMS	11
	4.1 Cat. A - Donor as Losing C/CSP	11
	4.2 Cat. A - Donor as Gaining C/CSP	17
	4.3 Cat. A - Third Party	23
5	CAT. A – PROCESS EVENTS AND VALIDATIONS	30
	5.1 Cat. A - Donor as Losing C/CSP	30
	5.2 Cat. A – Donor as Gaining C/CSP	37
	5.3 Cat. A – Third Party	45
6	CAT. A - THIRD PARTY PORT ACTIVITY	57
	6.1 SNA/TSNA Initiated	57
	6.2 Port Cutover	57
	6.3 SNA/TSNA Retarget	58
	6.4 SNA/TSNA Withdrawal	58
	6.5 Port Expiry	59
7	CAT. A - PORTING TIME FRAMES	60
8	CAT. A – RECORD DESCRIPTION	61
	8.1 SNA	61
	8.2 SNA Confirmation	61
	8.3 SNA Rejection	61
	8.4 SNA Retarget Notification	62
	8.5 SNA Retarget Confirmation	62
	8.6 SNA Retarget Rejection	62

8.7	SNA Withdrawal Notification	63
8.8	SNA Withdrawal Confirmation	63
8.9	SNA Withdrawal Rejection	63
8.10	ECA Cutover Notification	63
8.11	ECA Cutover Confirmation	64
8.12	ECA Cutover Rejection	64
8.13	SNA Completion Notification	64
8.14	SNA Expiry Notification	65
8.15	TSNA Port Notification	65
8.16	TSNA Port Confirmation	65
8.17	TSNA Port Rejection	65
8.18	TSNA Withdrawal Notification	66
8.19	TSNA Withdrawal Confirmation	66
8.20	TSNA Withdrawal Rejection	66
8.21	TECA Cutover Notification	67
8.22	TECA Cutover Confirmation	67
8.23	TECA Cutover Rejection	67
8.24	TSNA Completion Notification	68
8.25	TSNA Expiry Notification	68
<hr/>		
9	CAT. A – RESPONSE CODES	69
<hr/>		

1 CAT. A - CONTEXT DIAGRAMS

The following diagrams identify the agreed transactions that are to be supported for the Cat. A Process. A solid line " ←—————" indicates that the transaction is automated while a broken line " ←----- " indicates that the transaction is manually handled via agreed operational procedures.

1.1 Cat. A – Donor as Losing C/CSP



1.2 Cat. A - Donor as Gaining C/CSP

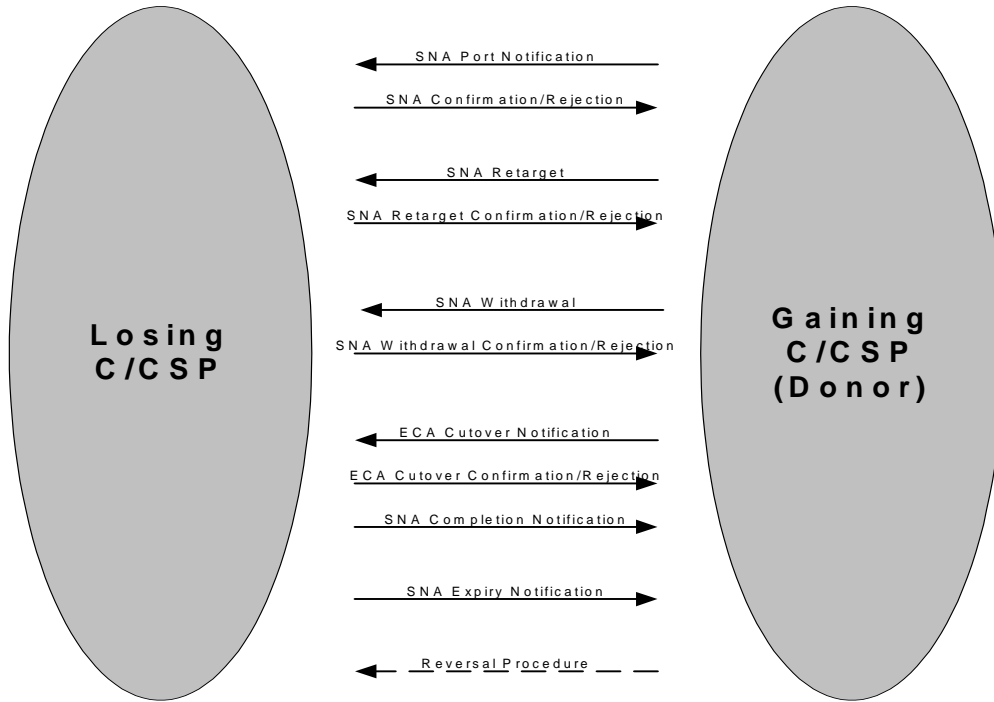

1.3 Cat. A - Third Party

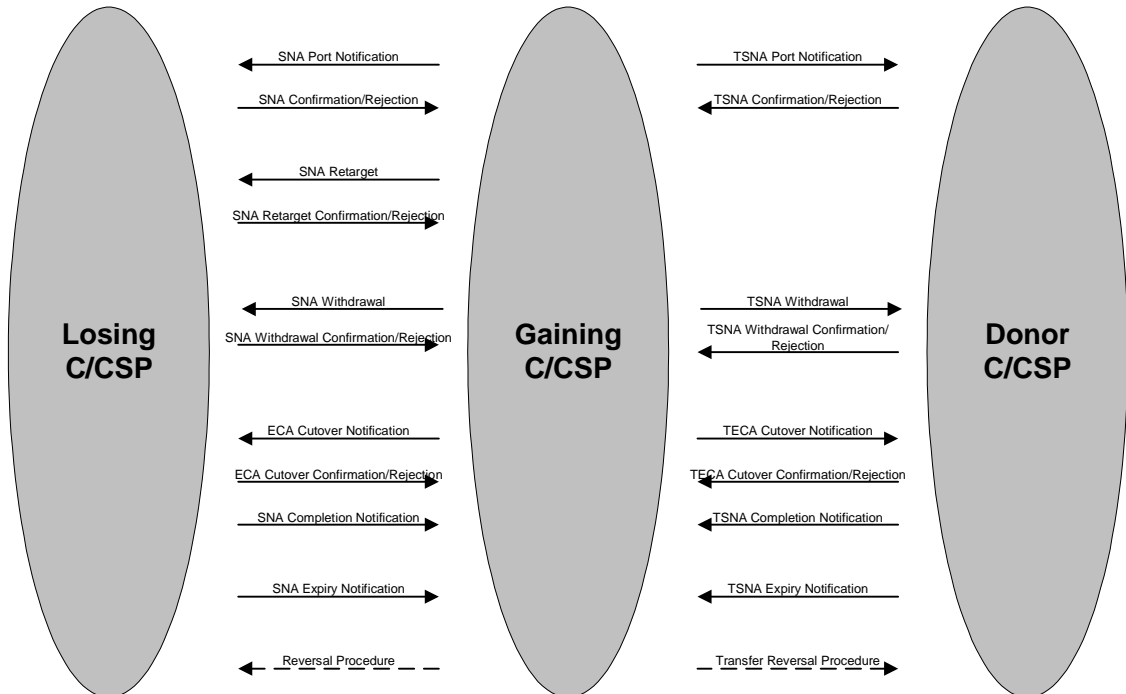

2 CAT. A – EVENT TREE DIAGRAMS

2.1 Cat. A - Donor as Losing C/CSP

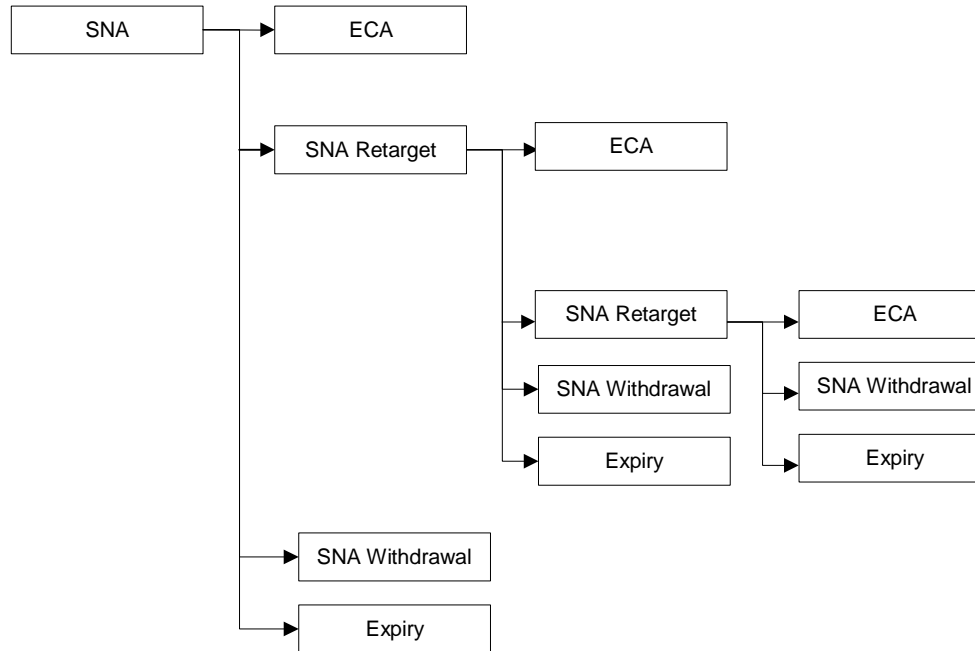

2.2 Cat. A - Donor as Gaining C/CSP

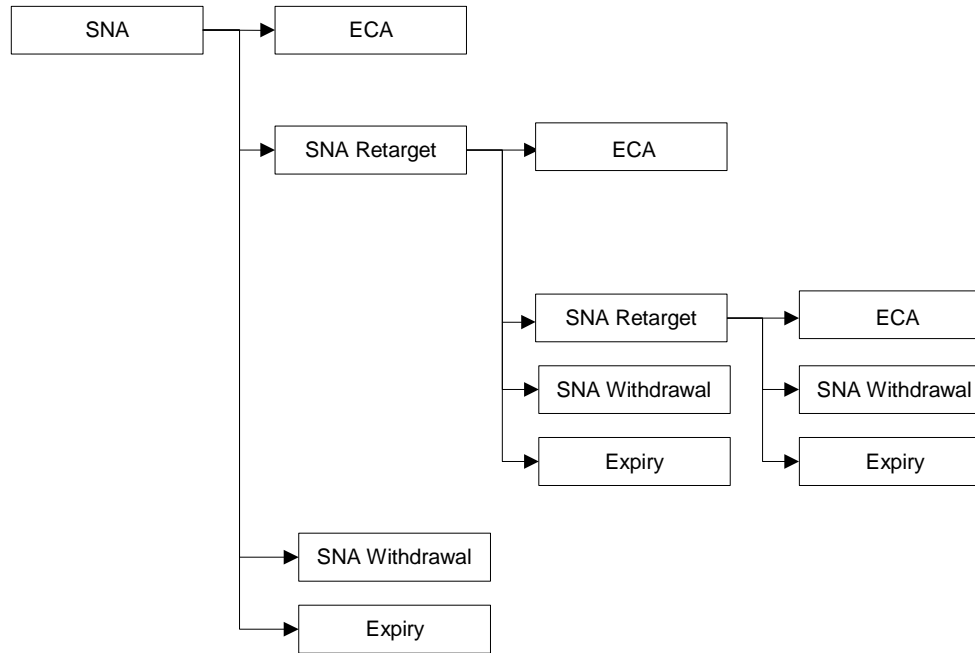

2.3 Cat. A – Third Party

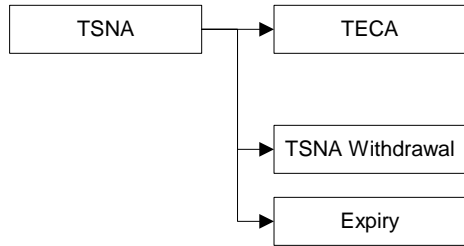

3 CAT. A – LIFETIME OF PORT

3.1 Cat. A - Donor as Losing C/CSP

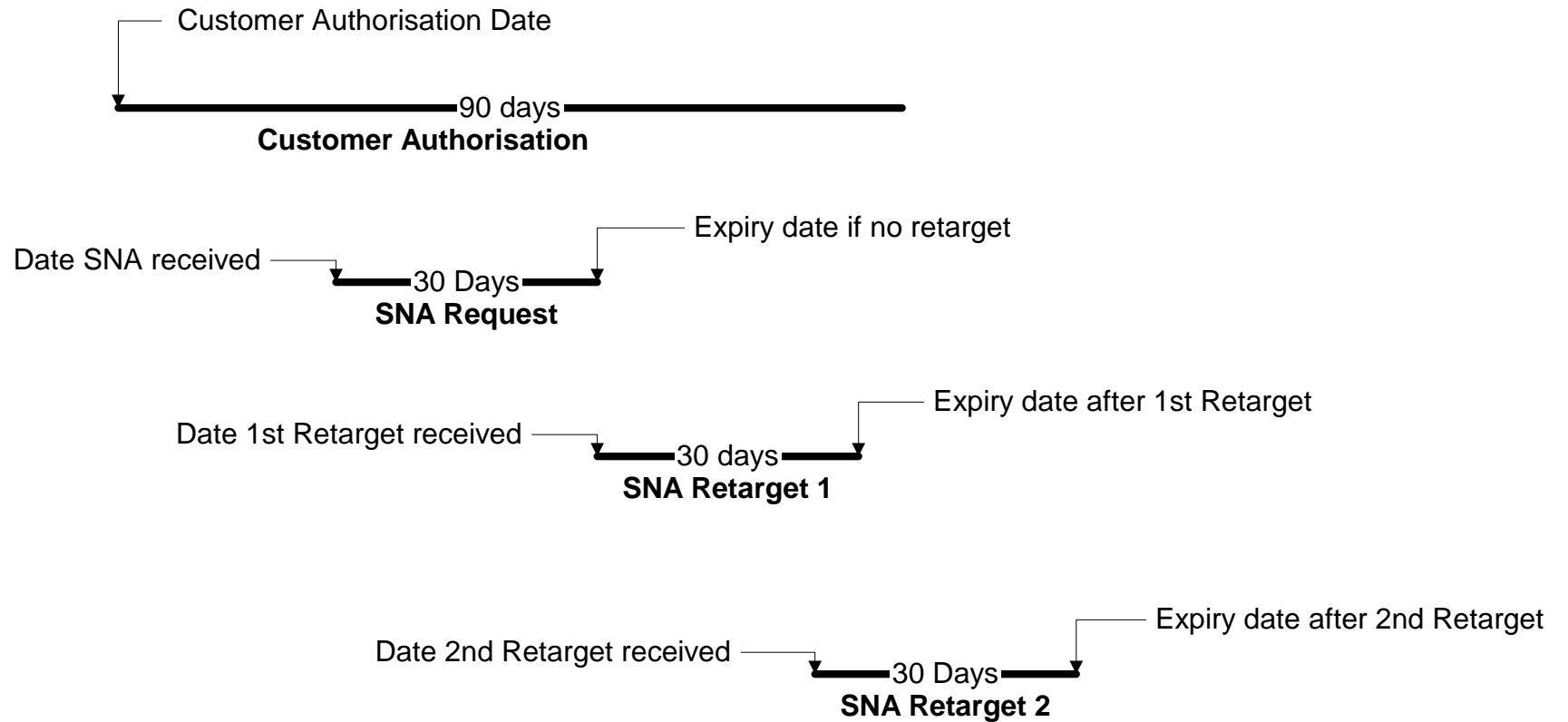

3.2 Cat. A - Donor as Gaining C/CSP

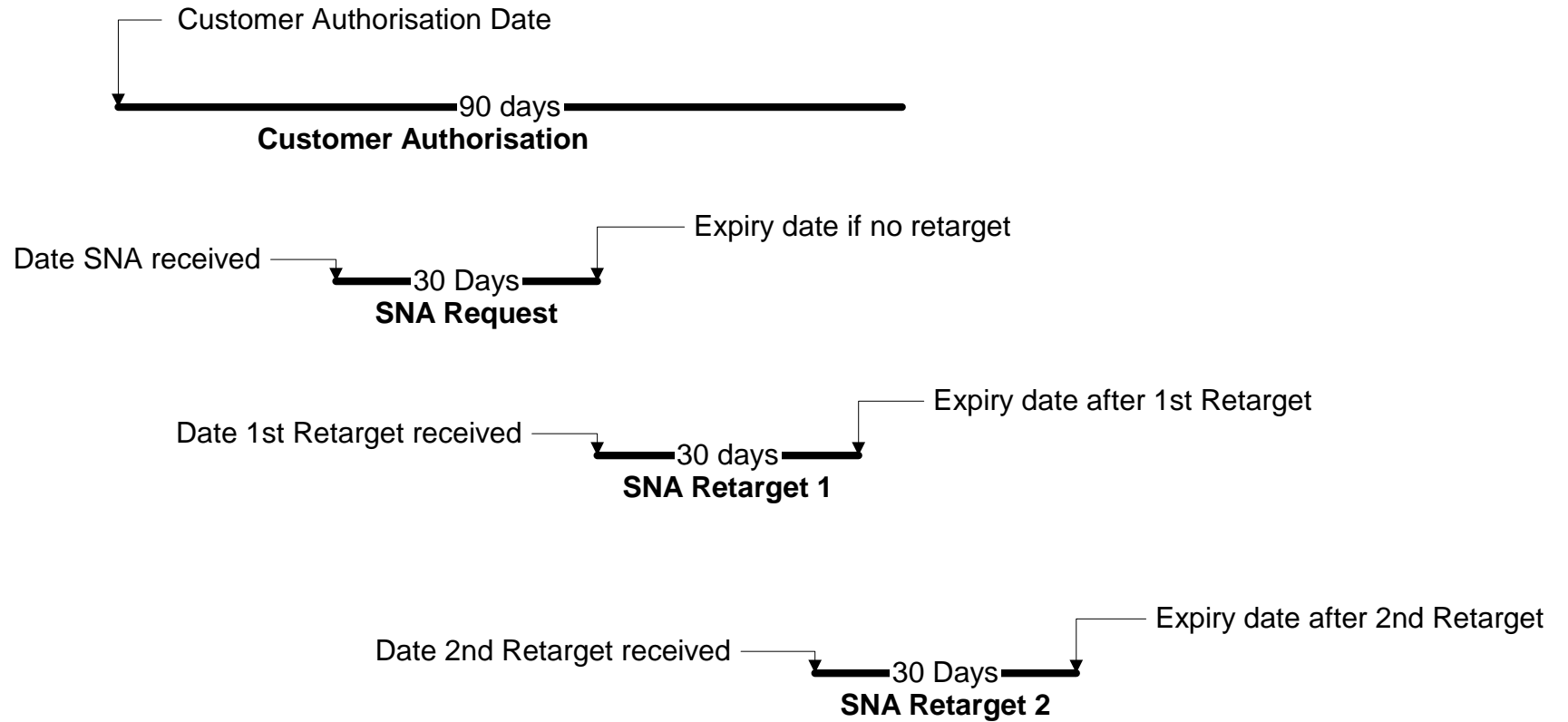

3.3 Cat. A – Third Party

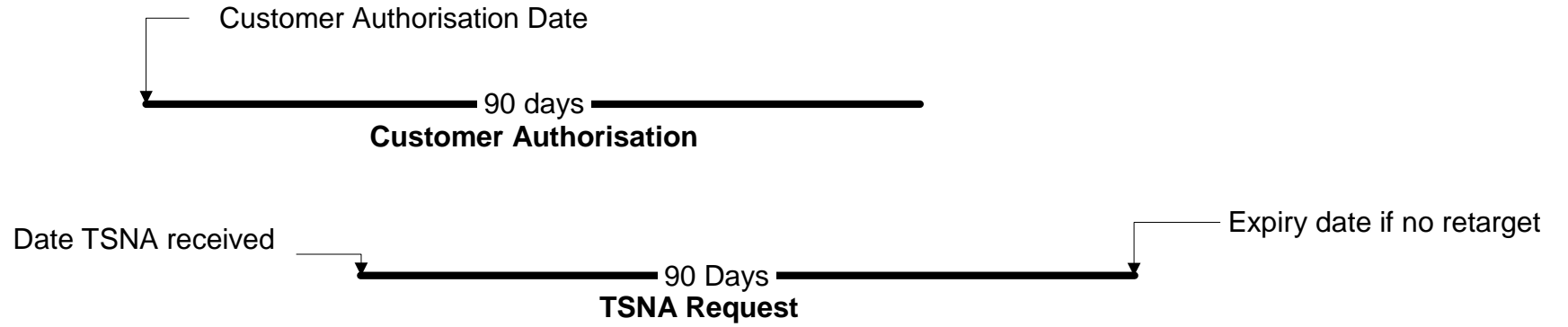

4 CAT. A -PROCESS FLOW DIAGRAMS

4.1 Cat. A - Donor as Losing C/CSP

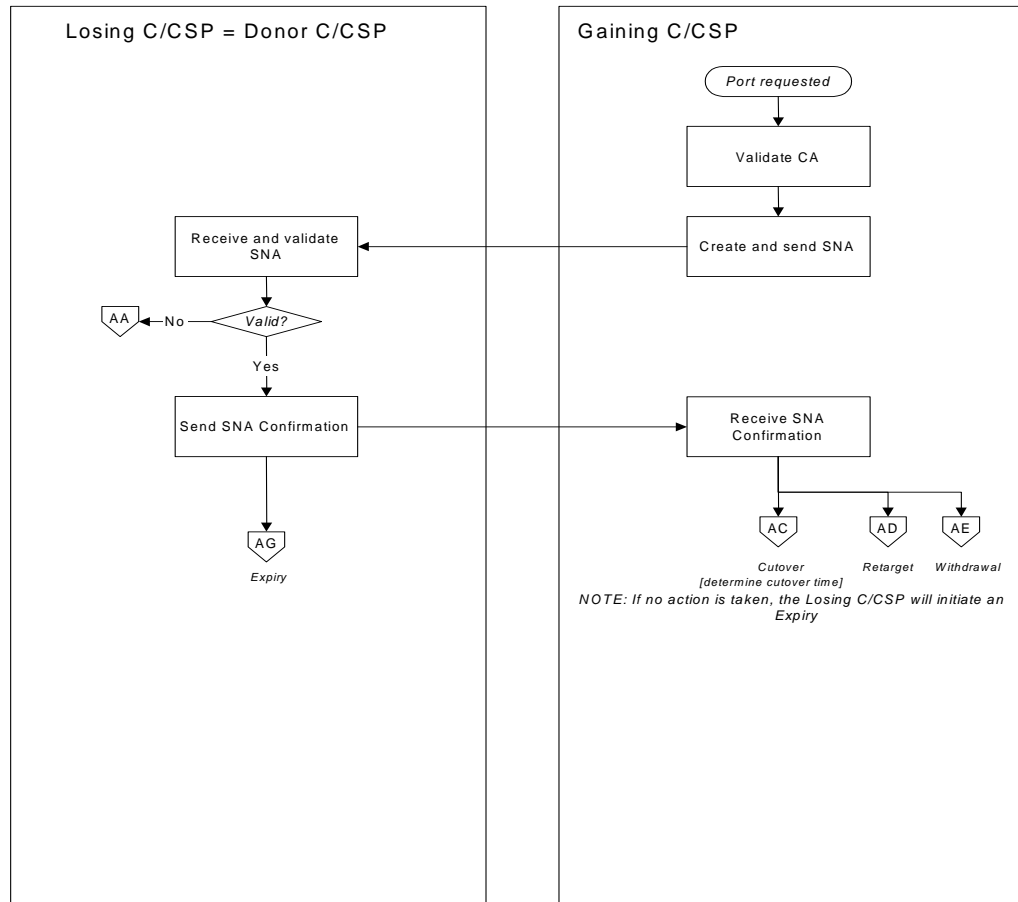

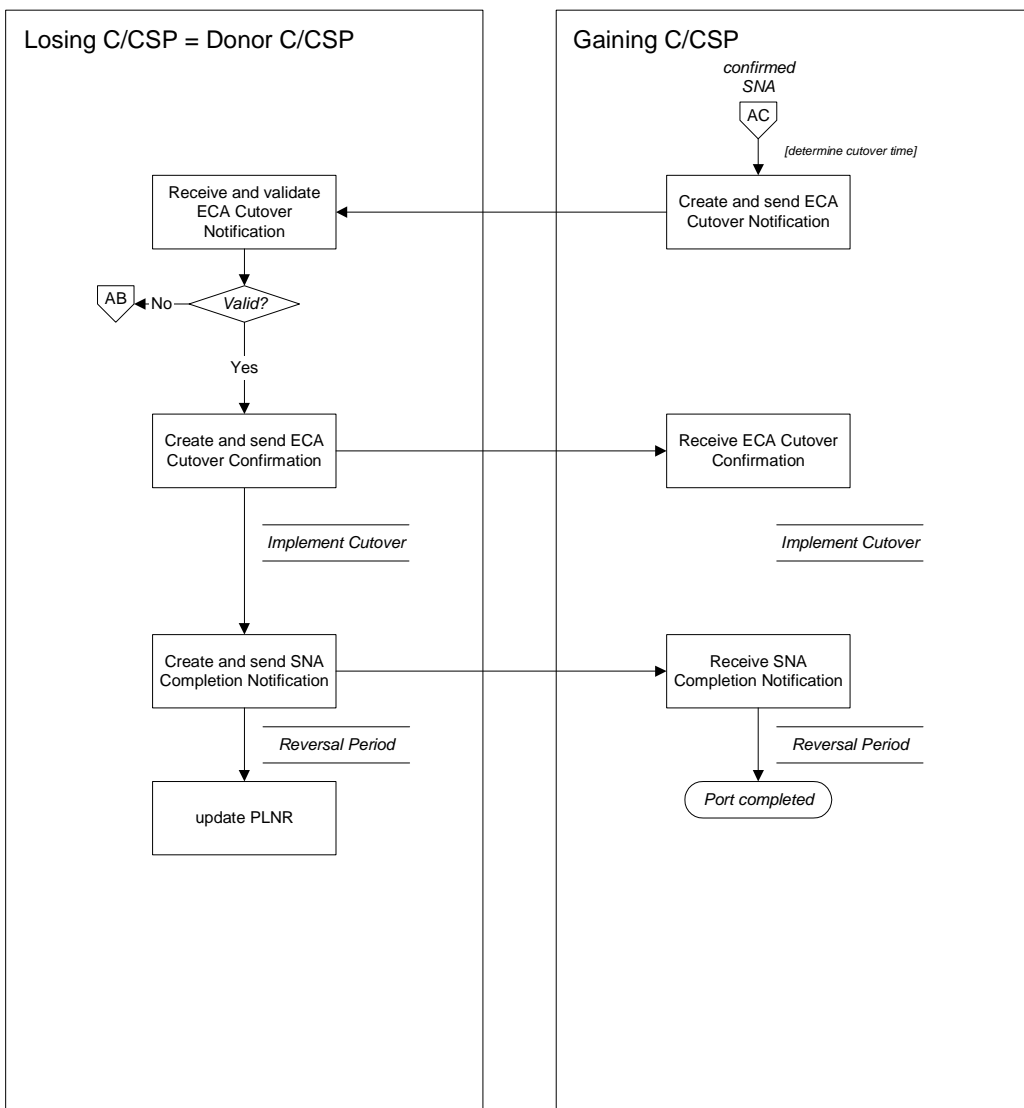

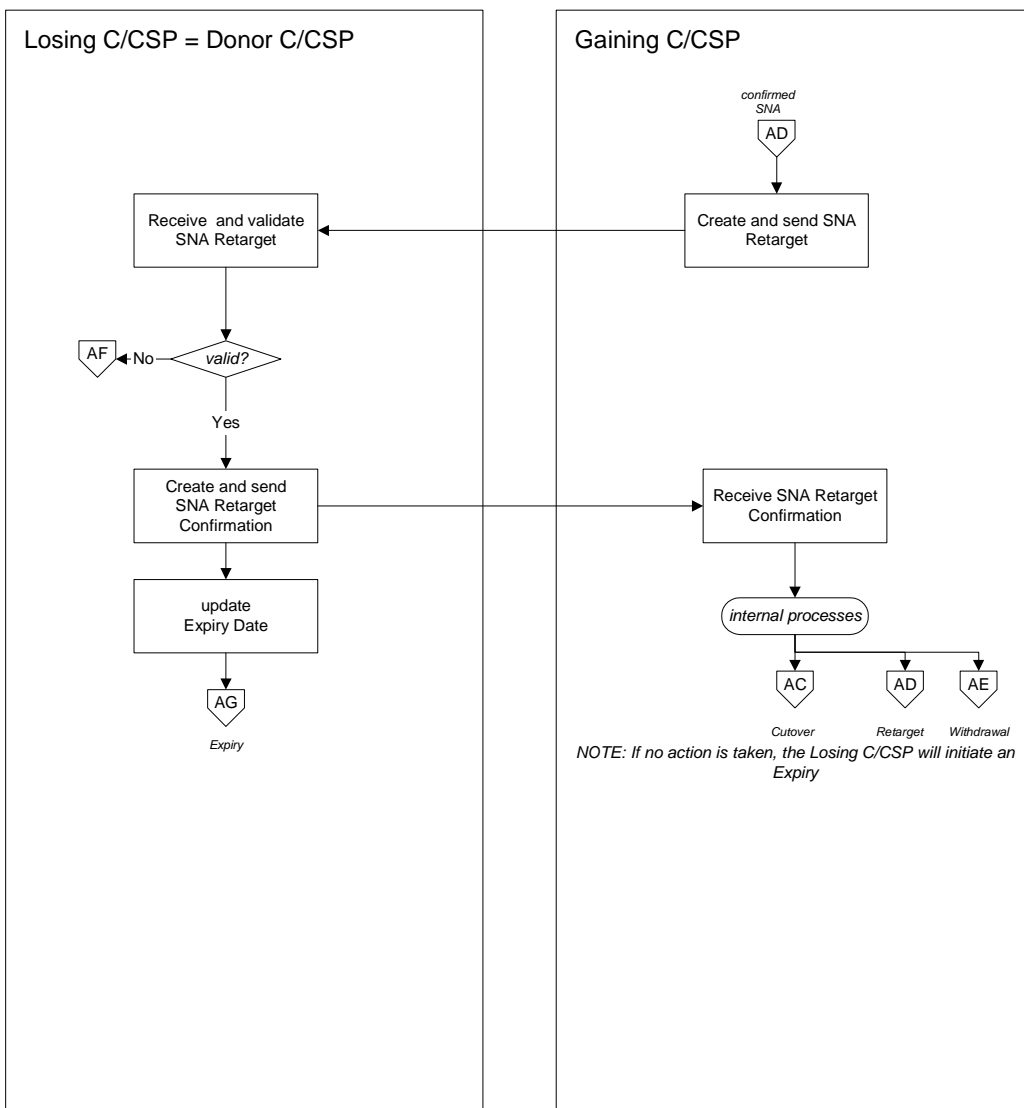

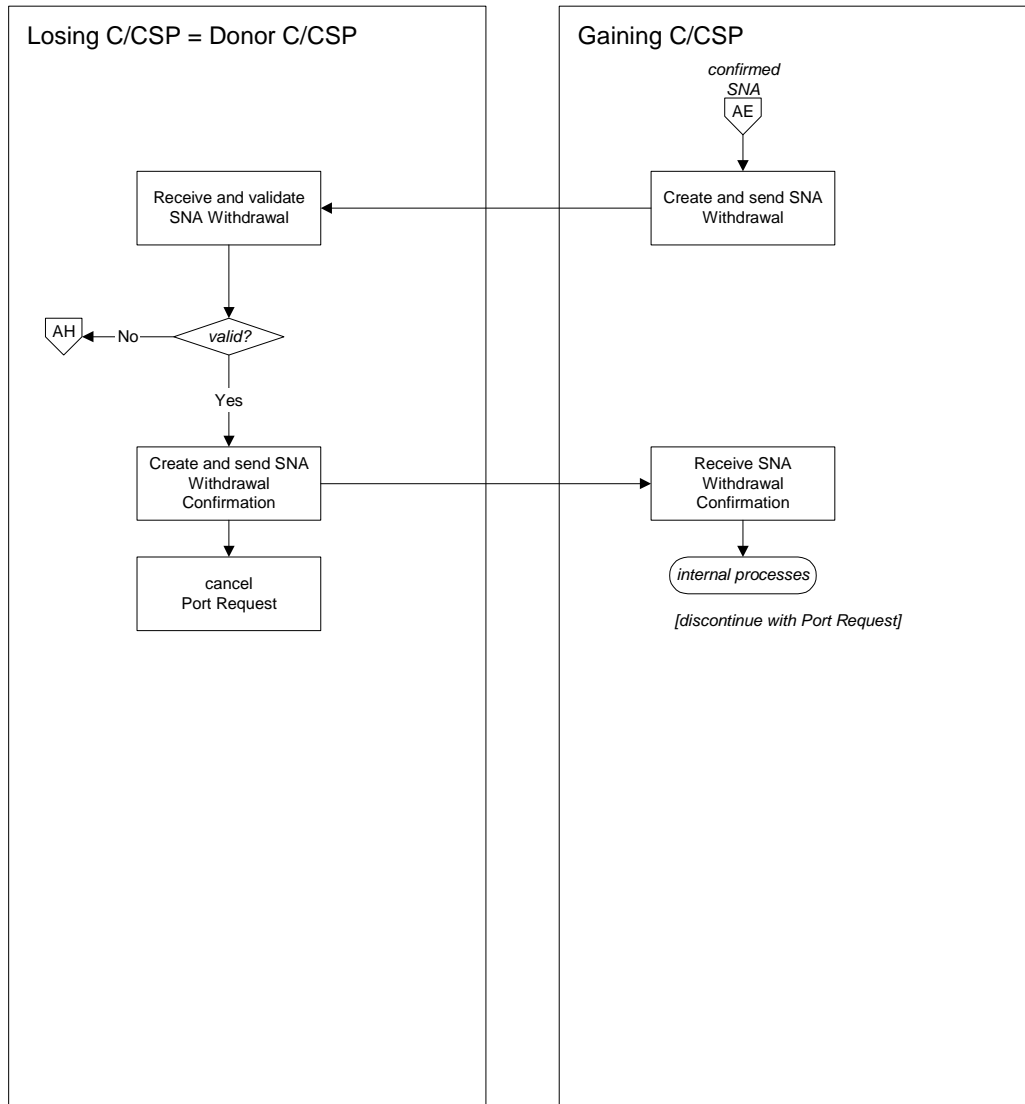

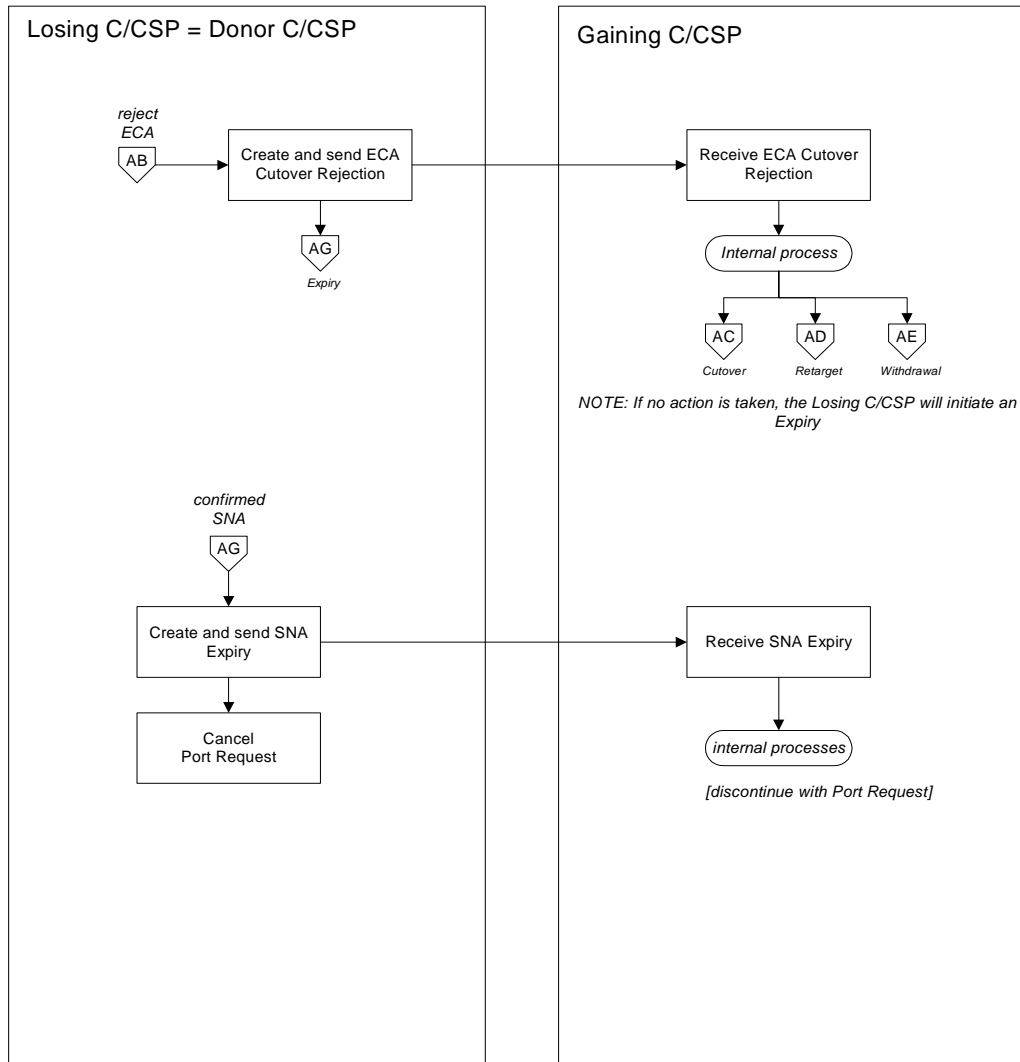

4.2 Cat. A - Donor as Gaining C/CSP

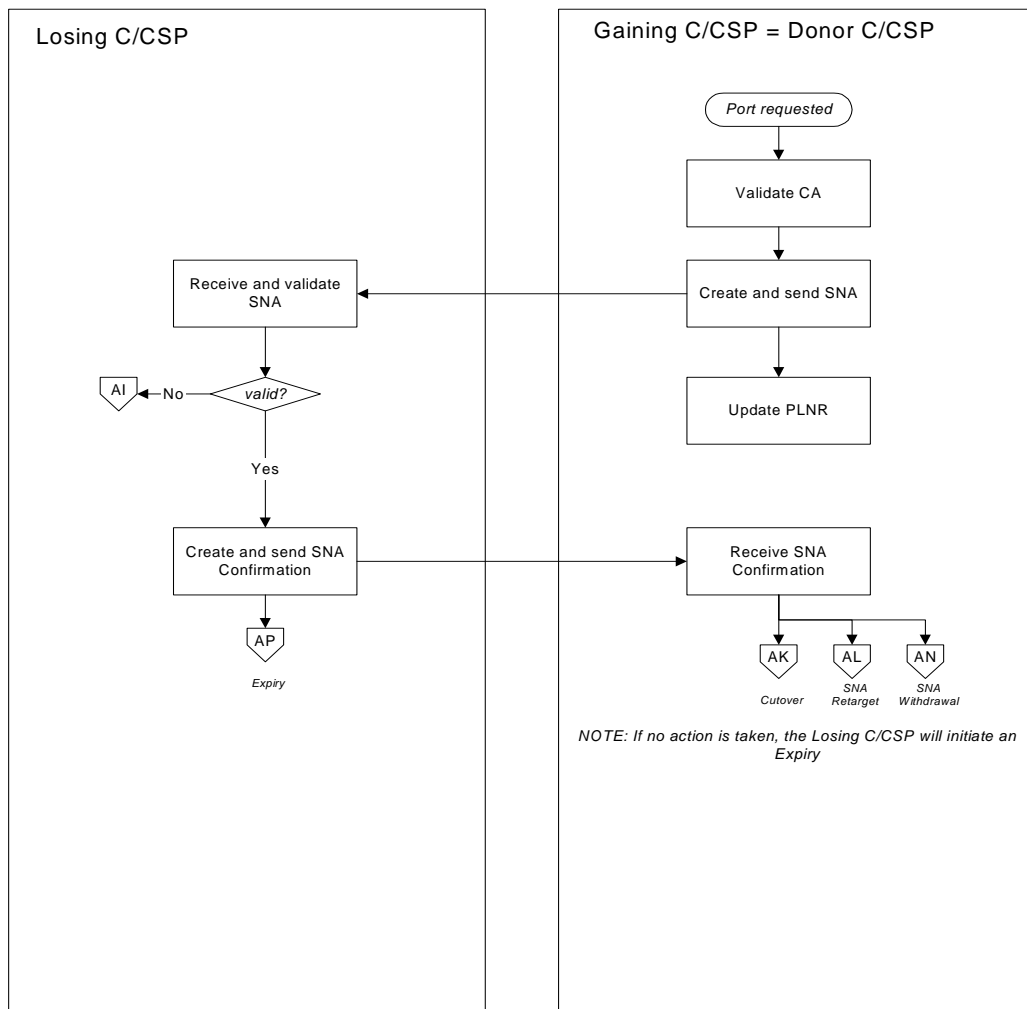

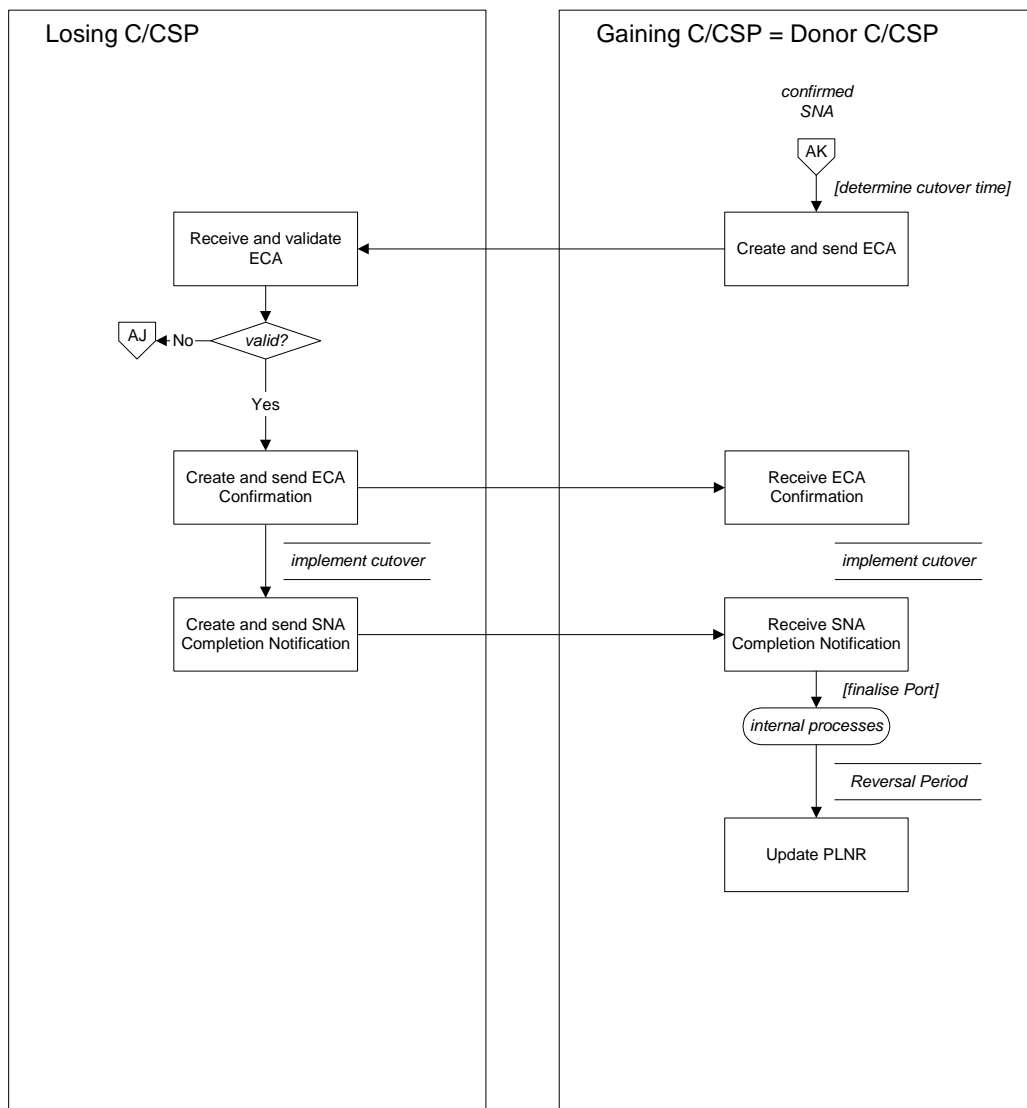

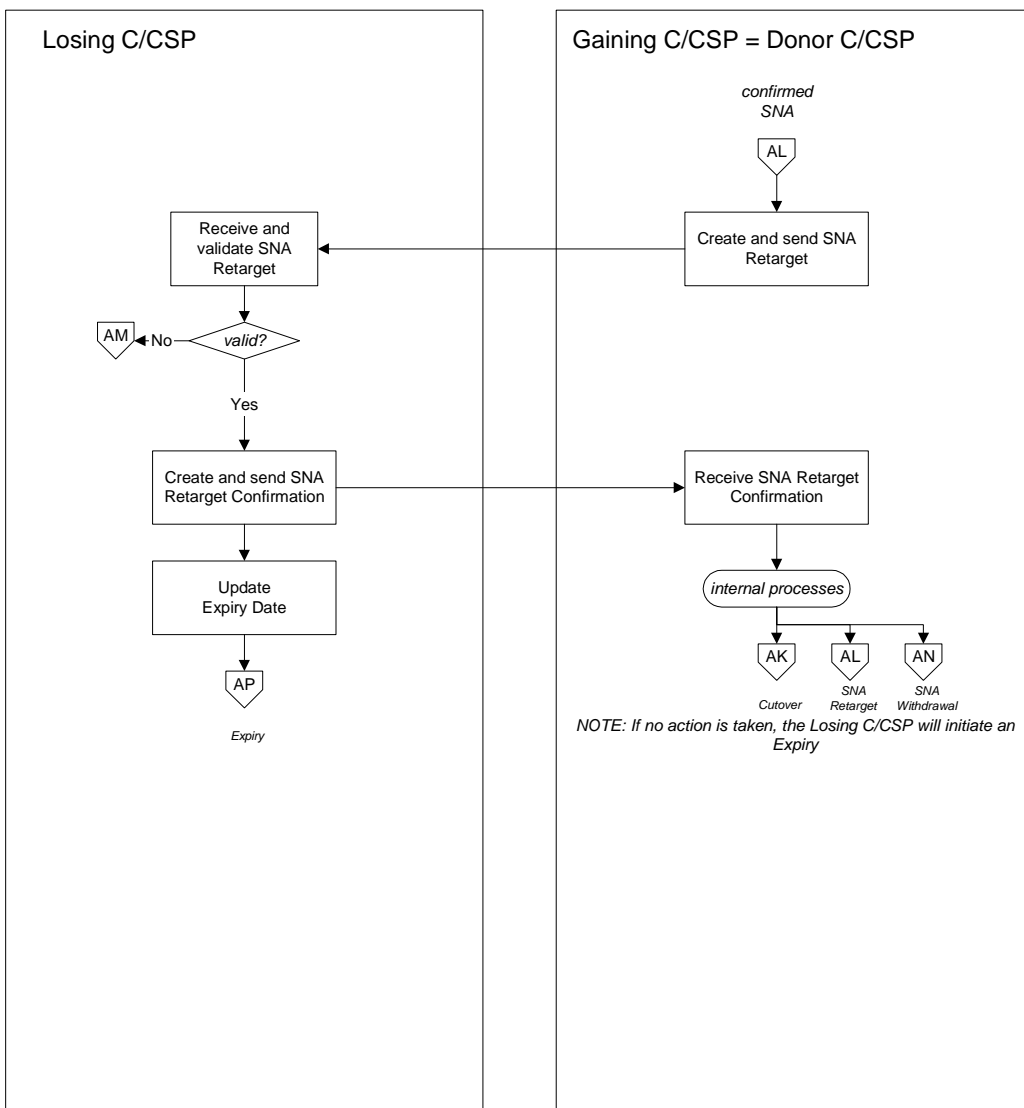

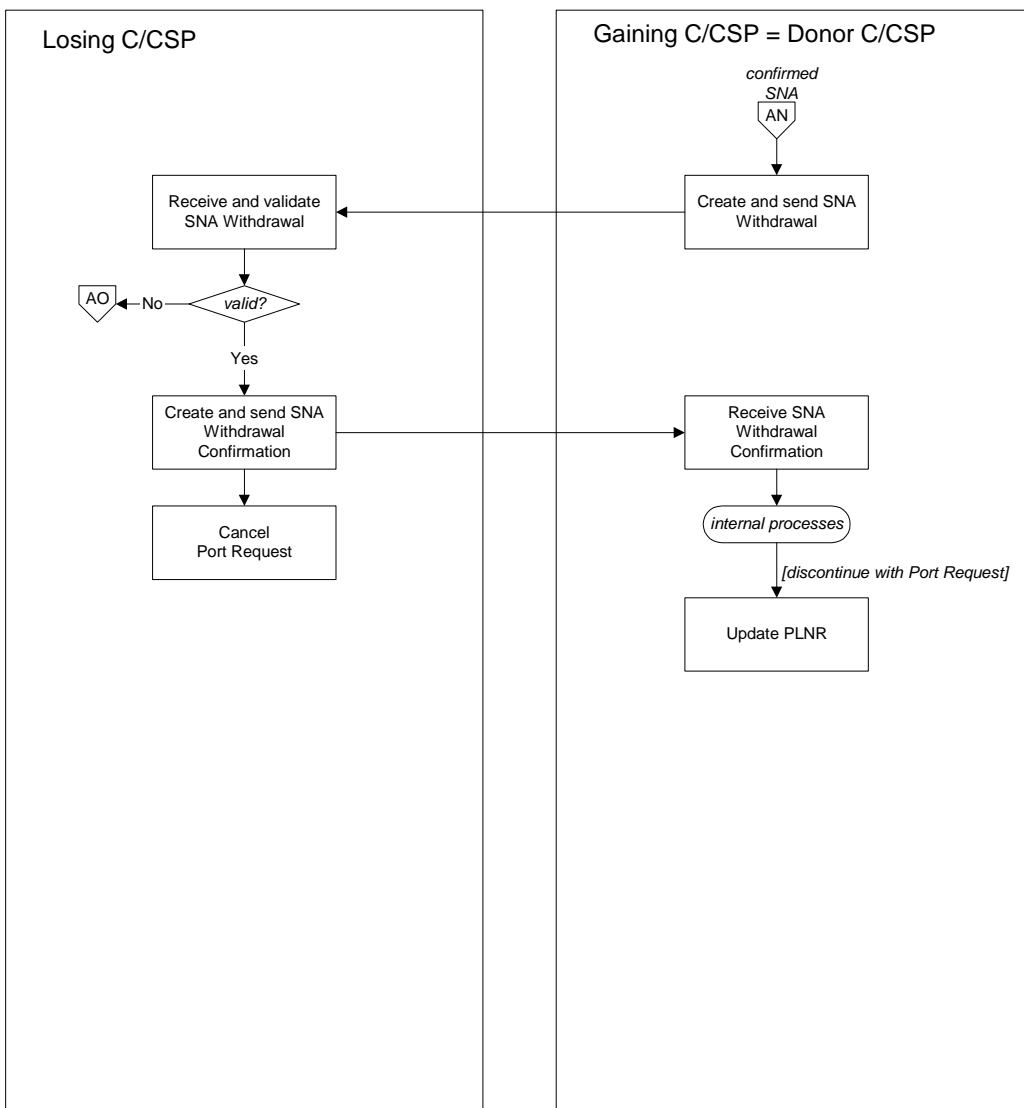

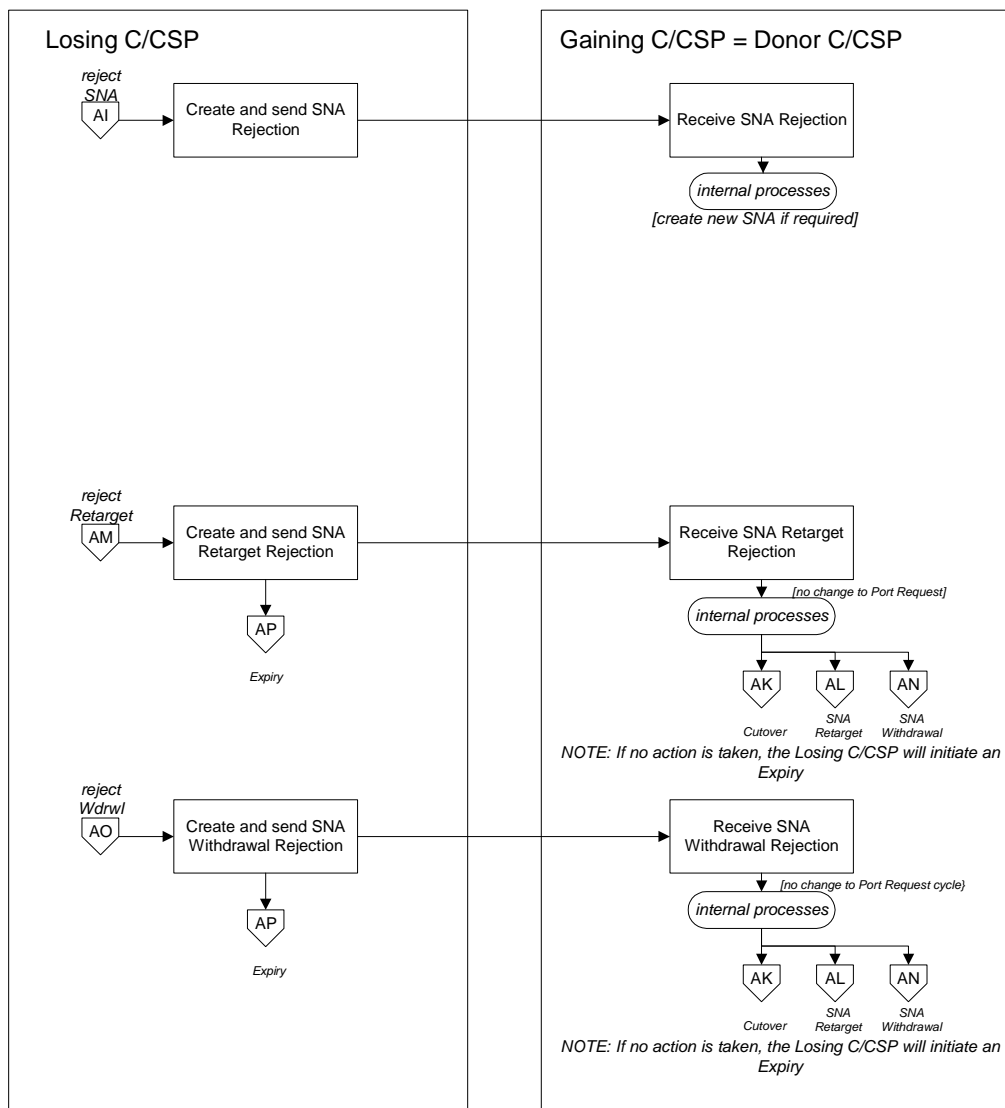

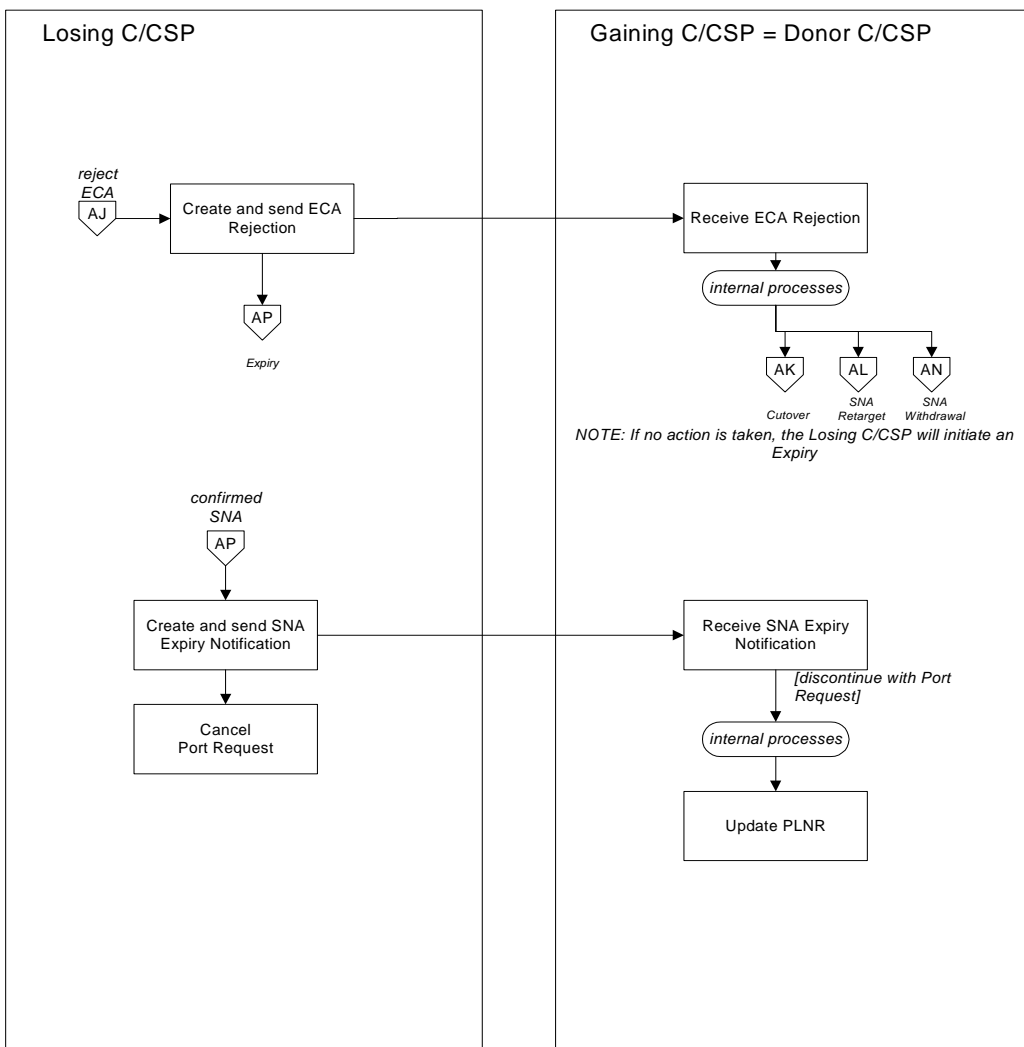

4.3 Cat. A - Third Party

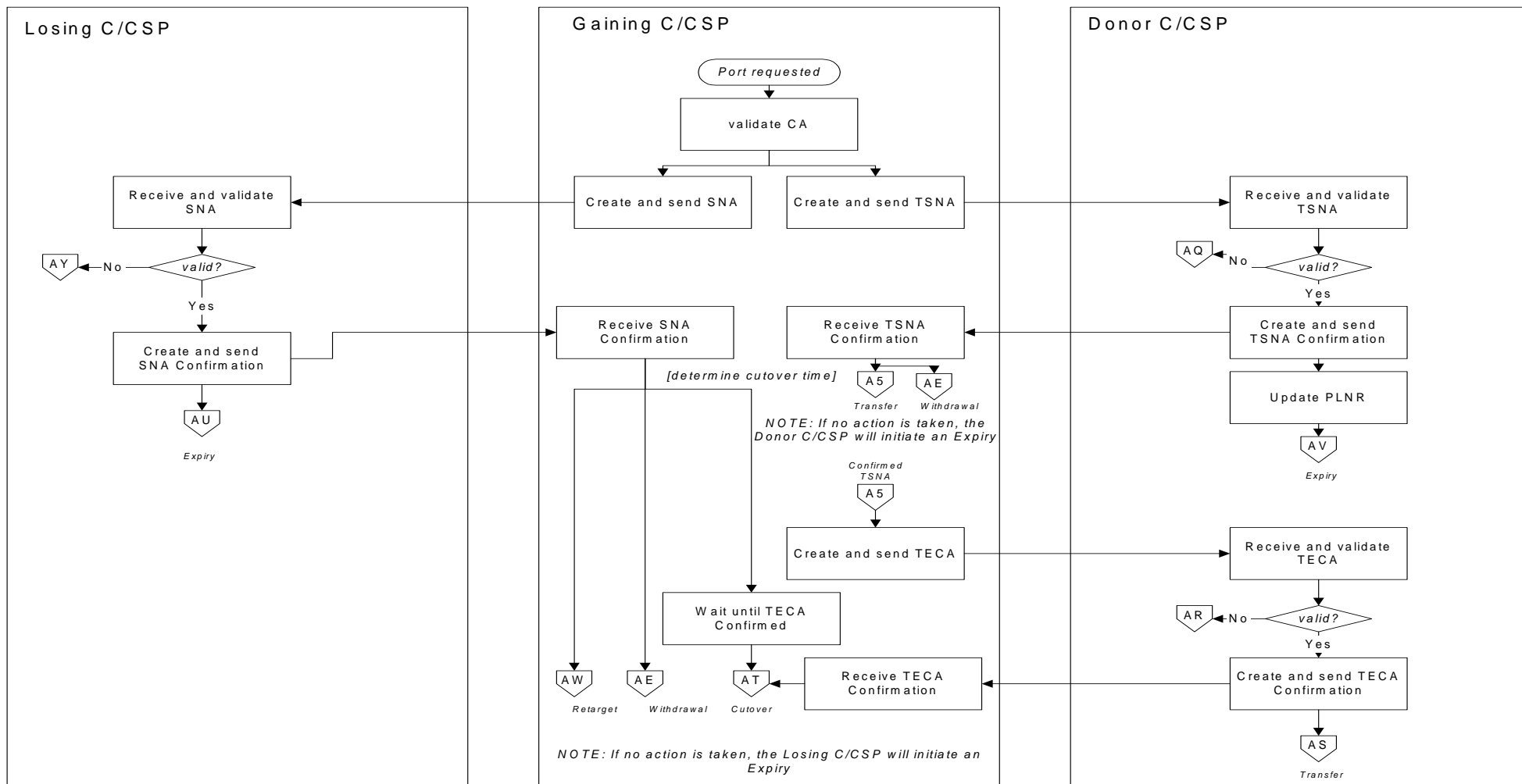

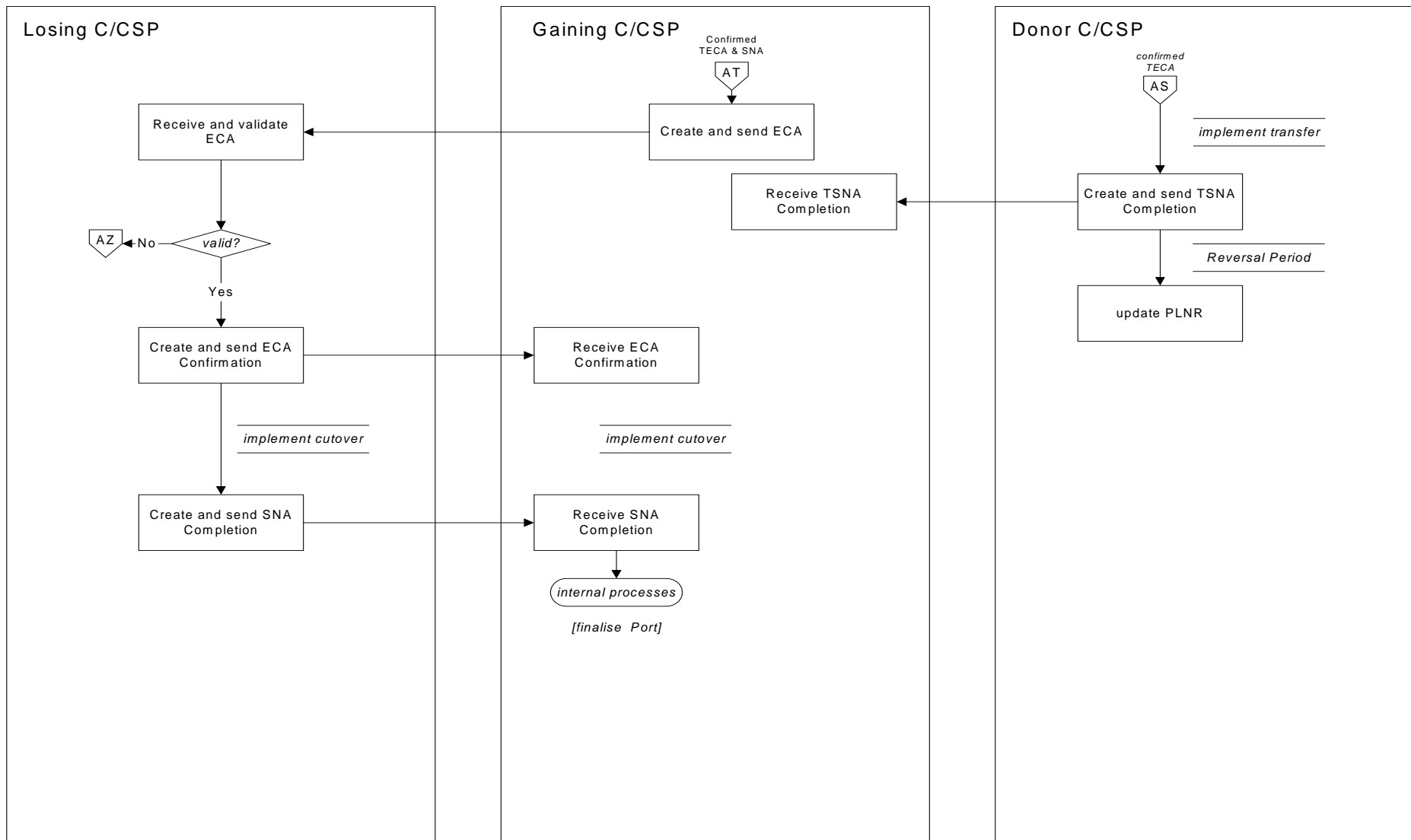

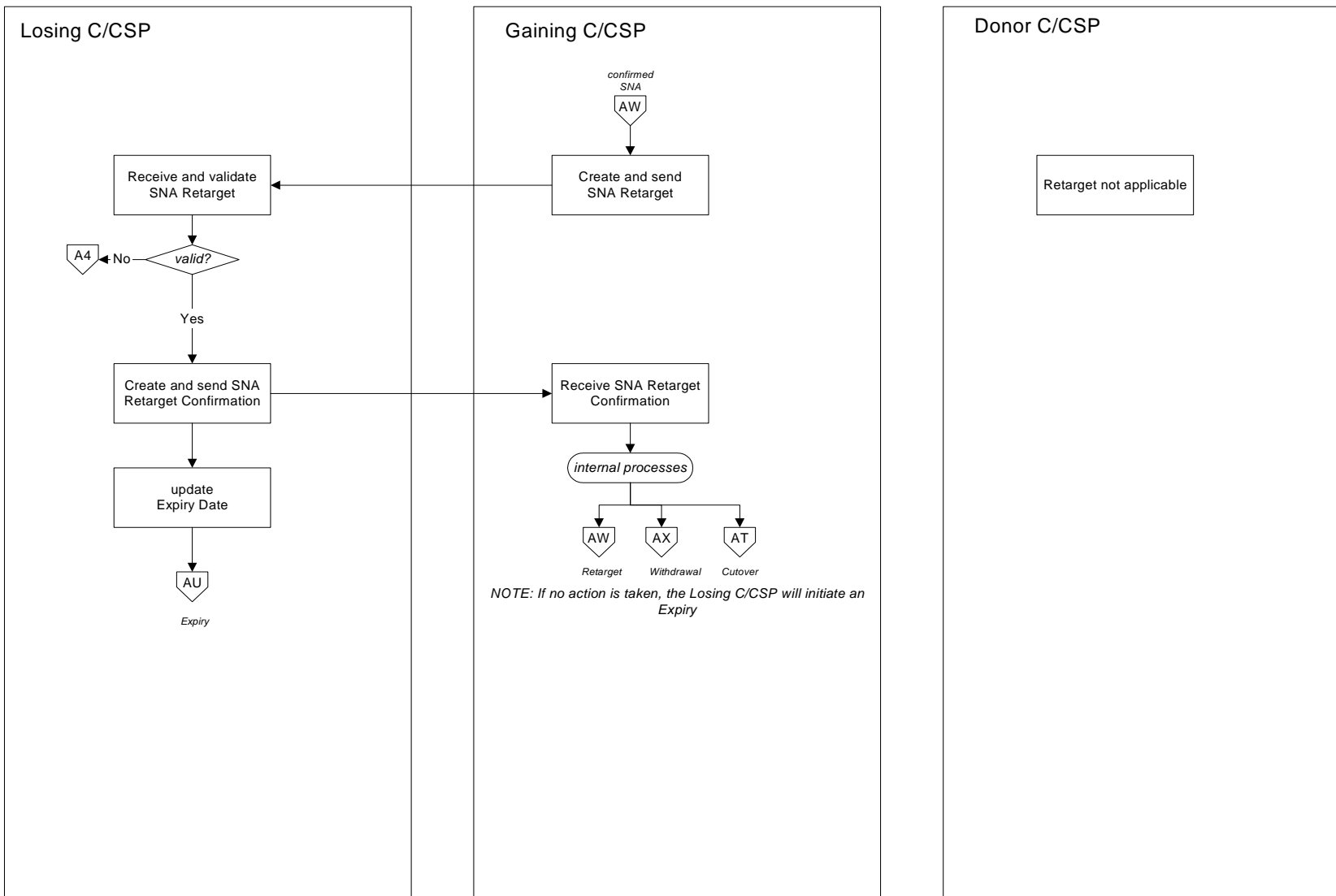

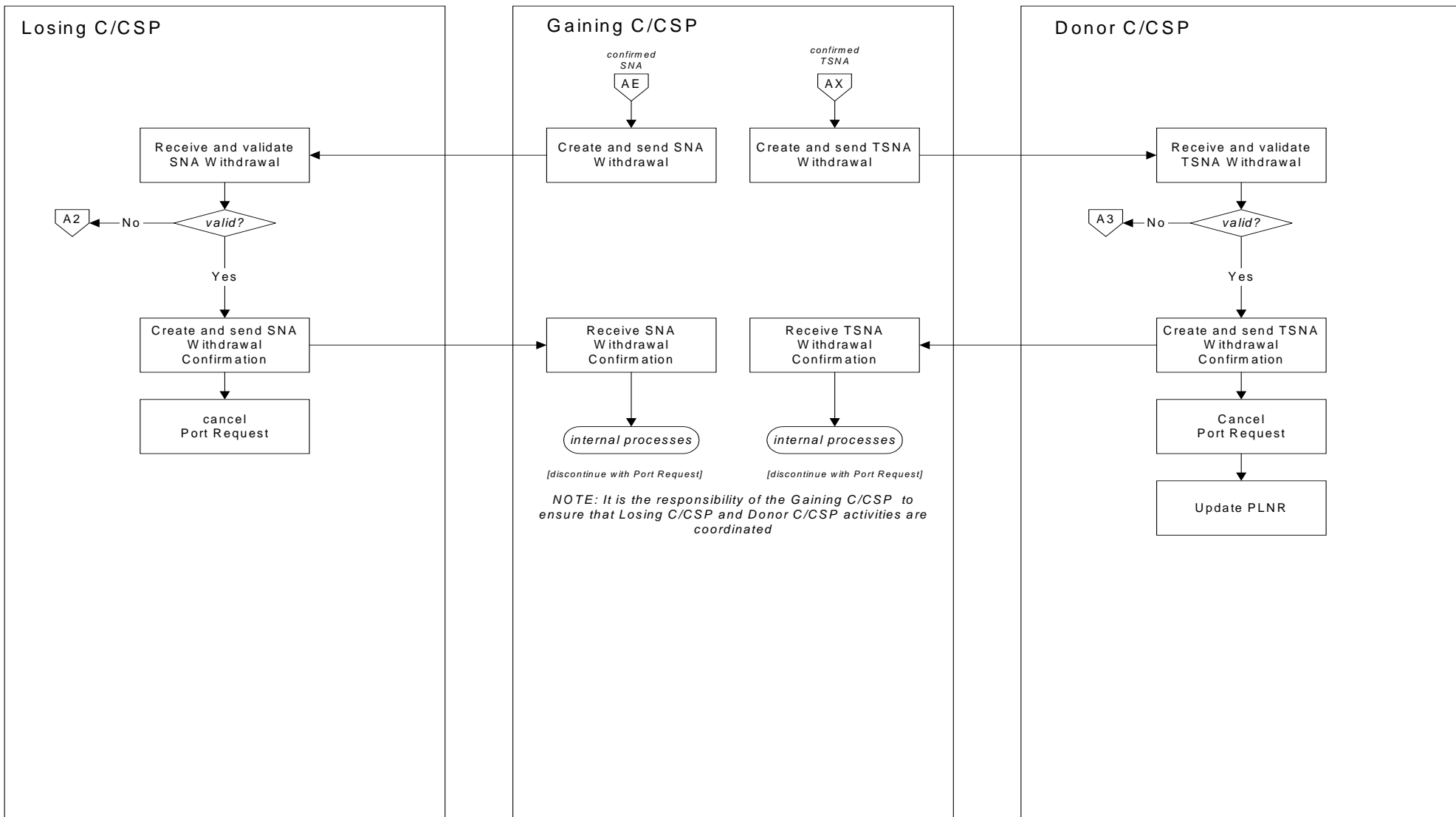

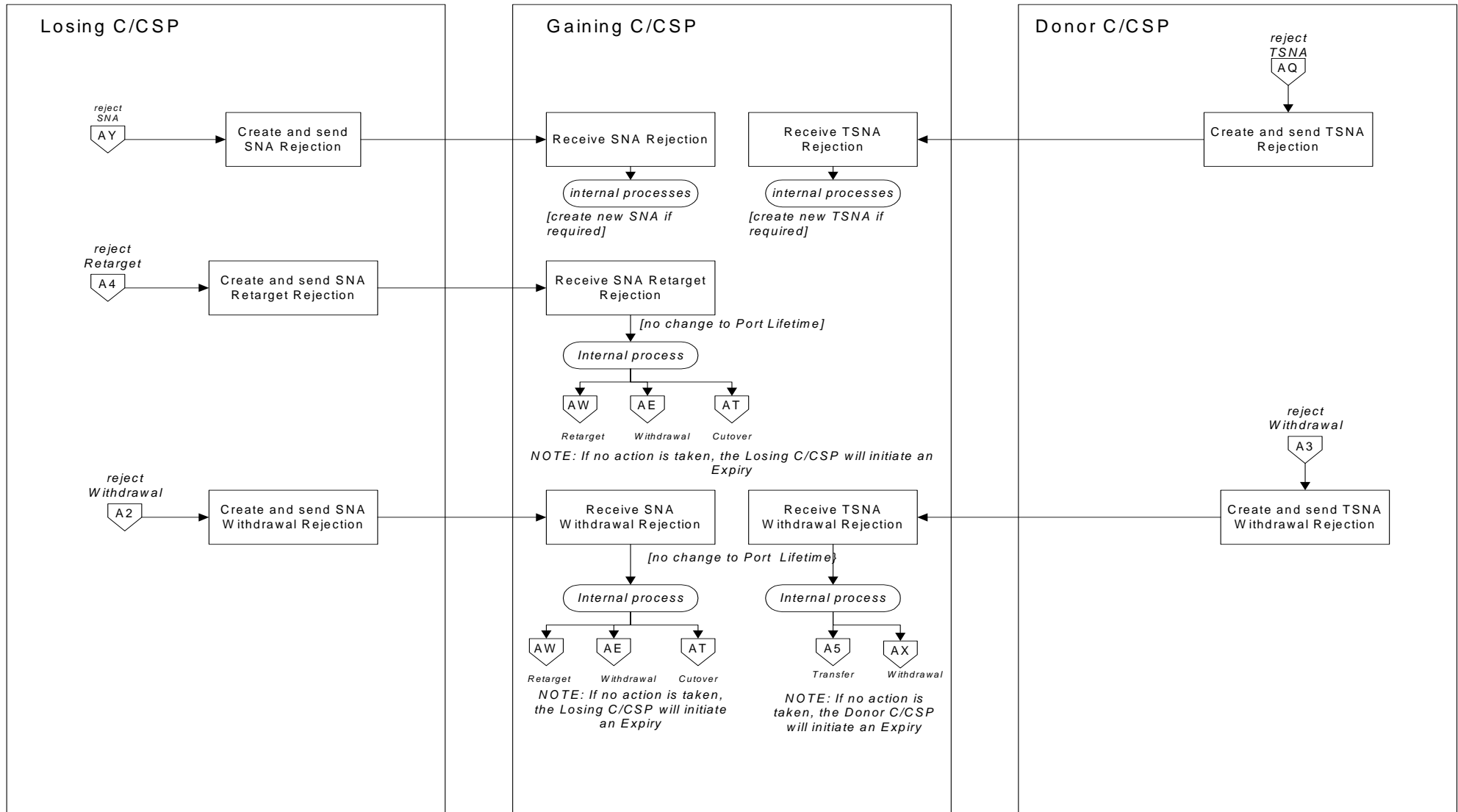

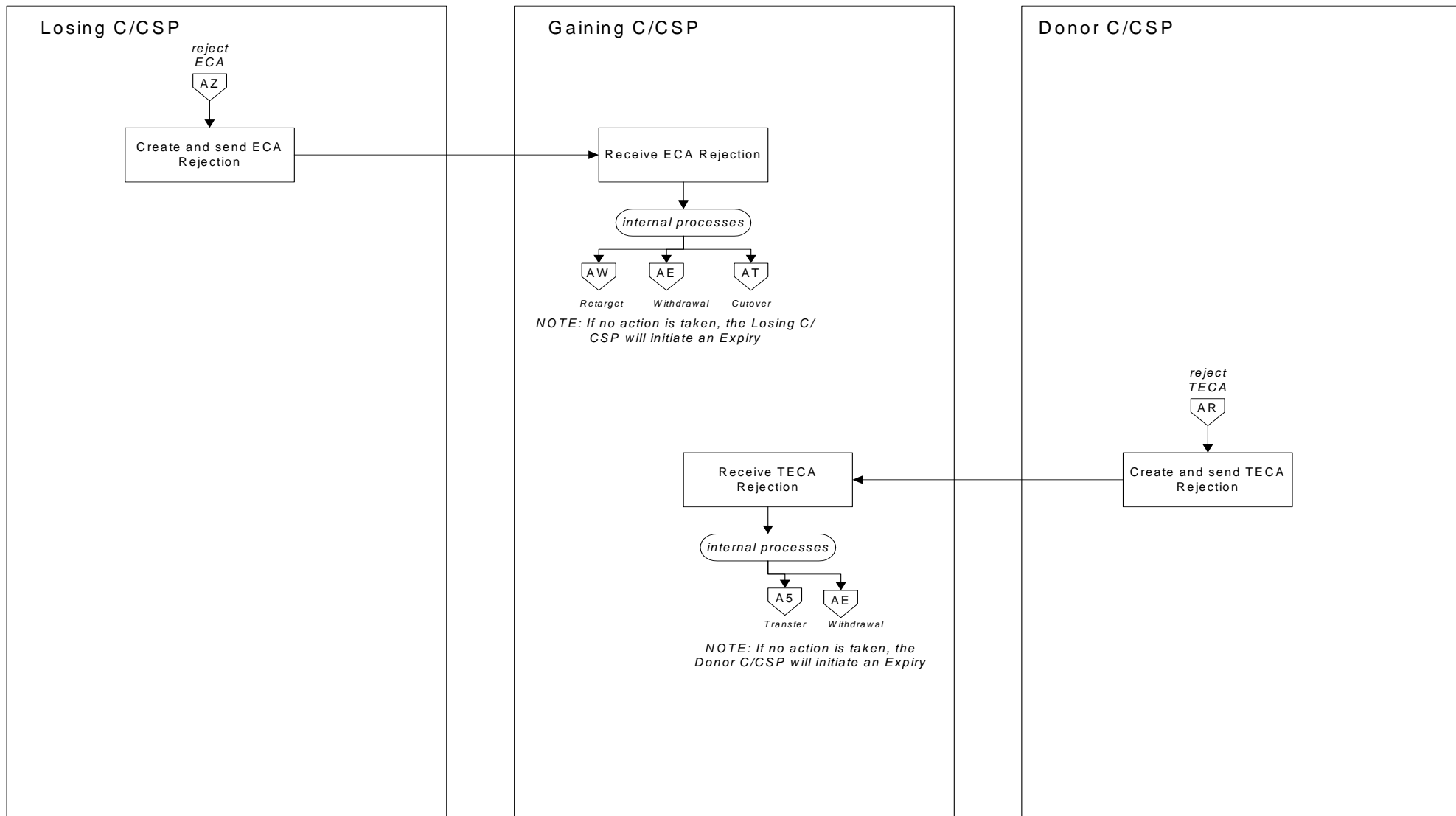

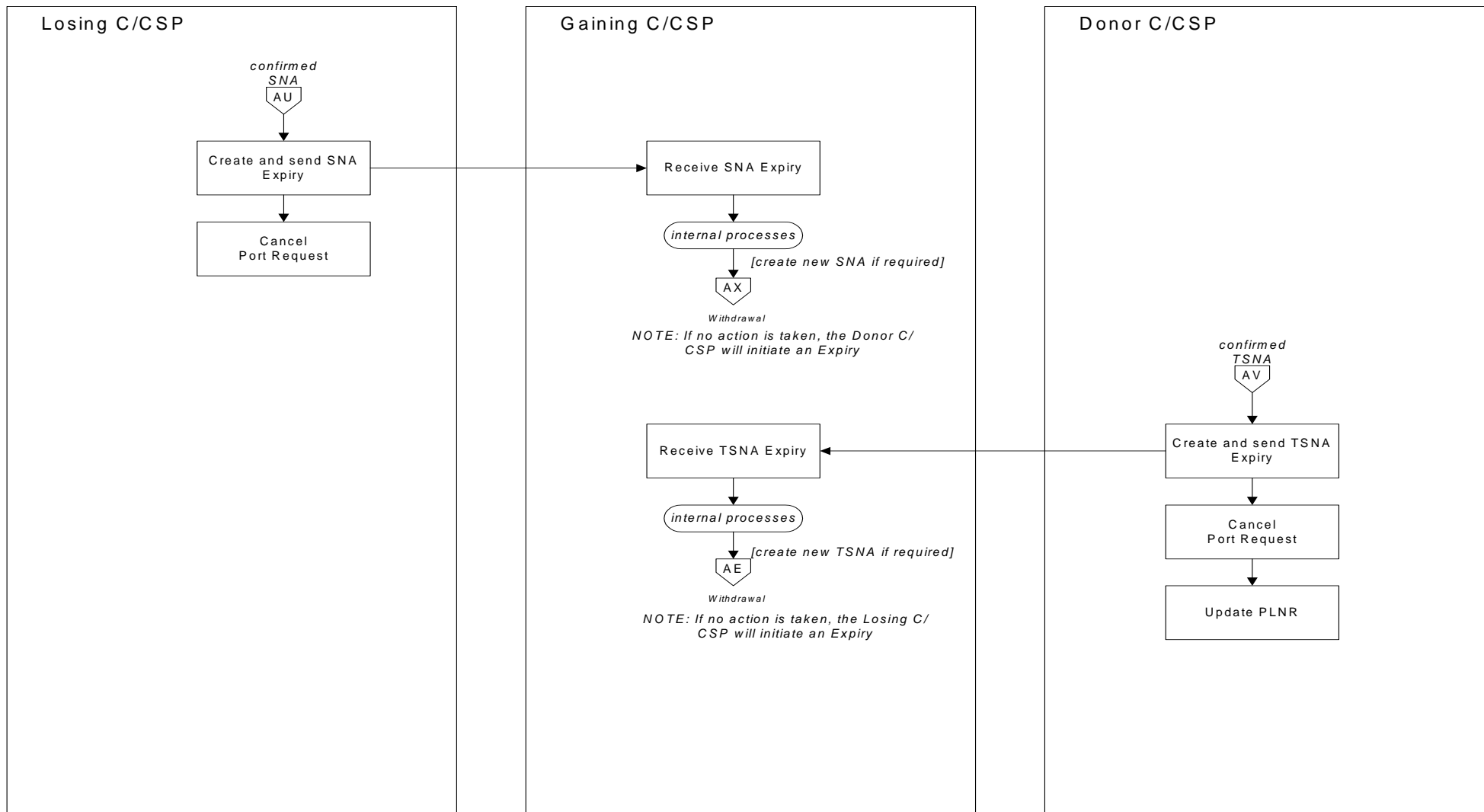

5 CAT. A – PROCESS EVENTS AND VALIDATIONS

5.1 Cat. A - Donor as Losing C/CSP

CAT. A – Donor as Losing C/CSP Legend for C/CSP: G is for Gaining C/CSP L is for Losing C/CSP D is for Donor C/CSP Legend for File: D is for Daily PNO H is for Hot Batch					
REF	Event	C/CSP	File	Description	Rules
1	Create and send an SNA	G	D	Utilised to notify the Losing C/CSP of a Telephone Number being Ported to another C/CSP.	
	Outcomes and Actions			SNA included in daily PNO file for forwarding to Losing C/CSP	
2	Receive and Validate SNA	L	D		Losing C/CSP shall validate and reject if: <ul style="list-style-type: none"> (a) incorrect record format (response code of 020) (b) the Telephone Number is not found (response code of 001) (c) the Telephone Number is already Ported to the Gaining C/CSP (response code of 009) (d) the Telephone Number is already Ported to another C/CSP (response code of 010) (e) the Telephone Number is owned and utilised by the Losing C/CSP ie. test service (response code of 011) (f) the Telephone Number is not active or not reserved (response code of 003) (g) the Telephone Number is not associated to the appropriate exchange technology that supports the Porting of Telephone Numbers (response code of 015) (h) the Telephone Number and account number provided is not a valid association (response code of 017)

CAT. A – Donor as Losing C/CSP					
Legend for C/CSP: G is for Gaining C/CSP L is for Losing C/CSP D is for Donor C/CSP			Legend for File: D is for Daily PNO H is for Hot Batch		
REF	Event	C/CSP	File	Description	Rules
2 cont					<ul style="list-style-type: none"> (i) the product associated to the Telephone Number is not a Cat A product i.e. Portable within two Business Days of receipt of the SNA Port Notification (response code of 005) (j) the Telephone Number is in the process of being Ported (response code of 008) (k) the Telephone Number is pending disconnection (response code of 004) (l) the CA date is more than 90 calendar days from receipt of the SNA Port Notification (response code of 067) (m) the category type is not defined and there is no valid association to the record type i.e. 002 is for Cat A(response code of 063) (n) all mandatory fields are not populated (response code of 018) (o) network based diversion (eg. network service only) (response code of 002)
	Outcomes and Actions				
3	Send SNA Confirmation/ Rejection	L	D	Utilised to notify the confirmation or rejection of a SNA made by the Gaining C/CSP.	Losing C/CSP must send an SNA Confirmation/Rejection within one Business Day of receipt of the SNA
	Outcomes and Actions			<p>Confirmation of the SNA will make the Port active.</p> <p>The expiry date for a confirmed SNA will be set 30 days from receipt of the notification (inclusive)</p> <p>Rejection of the SNA will not make the Port active</p>	
4	Receive SNA Confirmation/ Rejection	G	D		

CAT. A – Donor as Losing C/CSP					
Legend for C/CSP: G is for Gaining C/CSP L is for Losing C/CSP D is for Donor C/CSP			Legend for File: D is for Daily PNO H is for Hot Batch		
REF	Event	C/CSP	File	Description	Rules
	Outcomes and Actions			<p>Confirmation</p> <p>Confirmation of the SNA will make the Port active.</p> <p>The expiry date for a confirmed SNA will be set 30 days from receipt of the notification (inclusive)</p> <p>The Cutover must not be requested within two Business Days of the SNA.</p> <p>The Cutover should be requested within 30 calendar days of the SNA unless Retargeted.</p> <p>Rejection</p> <p>Internal operational process</p>	
5	Send ECA Cutover Notification	G	H	Utilised to notify the Losing C/CSP that the Cutover can commence on receipt of the ECA Cutover Notification	An ECA Cutover Notification must not be sent prior to the receipt of an SNA Confirmation from the Losing C/CSP.
	Outcomes and Actions				
6	Receive and Validate ECA Cutover Notification	L	H		<p>The Losing C/CSP will be required to validate and reject if :</p> <ul style="list-style-type: none"> (a) incorrect record format (response code of 020) (b) a confirmed and active SNA does not exist for the Telephone Number for the same Gaining C/CSP (response code of 035) (c) the account number and Telephone Number is not a valid association (response code of 017) (d) the ECA Cutover Notification is not received by the Losing C/CSP within standard hours and days of operations or as otherwise agreed (response code of 034) (e) the ECA Cutover Notification is not received a minimum two Business Days from receipt of the SNA (response code of 032) (f) not all mandatory fields are populated (response code of 018)

CAT. A – Donor as Losing C/CSP					
Legend for C/CSP: G is for Gaining C/CSP L is for Losing C/CSP D is for Donor C/CSP			Legend for File: D is for Daily PNO H is for Hot Batch		
REF	Event	C/CSP	File	Description	Rules
	Outcomes and Actions			Confirmation Implement Cutover. Activation Targets apply. Rejection No change to Port status	
7	Send ECA Cutover Confirmation/ Rejection	L	H	Utilised to notify confirmation or rejection of an ECA Cutover Notification made by the Gaining C/CSP.	Losing C/CSP must send an ECA Cutover Confirmation/Rejection within 15 minutes of receipt of the ECA Cutover Notification
	Outcomes and Actions			ECA Cutover Confirmation/Rejections will be sent in standard operational hours or as otherwise agreed if the ECA Cutover Notification was received within agreed Business Days and hours of operation.	
8	Receive ECA Cutover Confirmation/ Rejection	G	H		
	Outcomes and Actions			Confirmation Implement Cutover. Rejection Internal operational process	
9	Completion of the Cutover	L	N/A		
	Outcomes and Actions			Completed Cutover will cause an SNA Completion Notification to be sent to the Gaining C/CSP within 15 minutes of Cutover	
10	Send SNA Completion Notification	L	H	Utilised to notify the Gaining C/CSP of the completion of the Port.	
	Outcomes and Actions			Update Ported Local Number Register	
11	Update Ported Local Number Register	L/D	N/A	The PLNR is only updated following the end of the Reversal Period. If a Reversal is called, the PLNR is not updated.	The first update of the PLNR for the Telephone Number will add a new entry consisting of the Telephone Number, Gaining C/CSP's numeric code and the indicator "A". The next update of the PLNR will remove the indicator "A" from the entry for the Telephone Number.
	Outcomes and Actions			Ported Local Number Register updated	

CAT. A – Donor as Losing C/CSP					
Legend for C/CSP: G is for Gaining C/CSP L is for Losing C/CSP D is for Donor C/CSP			Legend for File: D is for Daily PNO H is for Hot Batch		
REF	Event	C/CSP	File	Description	Rules
12	Receive SNA Completion Notification	G	H		
	Outcomes and Actions				
13	Send SNA Retarget Notification	G	D	Utilised to extend the valid period of the SNA by another thirty days from receipt of the SNA Retarget Notification	
	Outcomes and Actions				
14	Receive and Validate SNA Retarget Notification	L	D		Losing C/CSP shall validate and reject if: (a) incorrect record format (response code of 020) (b) a confirmed and active SNA does not exist for the Telephone Number for the same Gaining C/CSP (response code of 057) (c) the SNA Retarget Notification does exceed two confirmed Retargets in total (response code of 037) (d) not all mandatory fields are populated (response code of 018) (e) not received at least one Business Day prior to the expiry of the SNA (response code of 032)
	Outcomes and Actions				
15	Send SNA Retarget Confirmation/Rejection	L	D	Utilised to notify the confirmation or rejection of a SNA Retarget Notification made by the Gaining C/CSP.	Losing C/CSP sends SNA Retarget Confirmation/Rejection within one Business Day of receipt of the SNA Retarget Notification
	Outcomes and Actions			Losing C/CSP sends SNA Retarget Confirmation/Rejection within one Business Day of receipt of the SNA Retarget Notification Confirmations will cause the expiry date to be moved 30 calendar days forward from the receipt of the SNA Retarget Notification.	

CAT. A – Donor as Losing C/CSP					
Legend for C/CSP: G is for Gaining C/CSP L is for Losing C/CSP D is for Donor C/CSP			Legend for File: D is for Daily PNO H is for Hot Batch		
REF	Event	C/CSP	File	Description	Rules
16	Receive SNA Retarget Confirmation/ Rejection	G	D		
	Outcomes and Actions			Rejection Internal operational process	
17	Send SNA Withdrawal Notification	G	D	Utilised to notify the Losing C/CSP of a withdrawal of the original SNA made by the Gaining C/CSP.	
	Outcomes and Actions				
18	Receive and Validate SNA Withdrawal Notification	L	D		Losing C/CSP shall validate and reject if: (a) in correct record format (response code of 020) (b) a confirmed and active SNA does not exist for the Telephone Number for the same Gaining C/CSP (response code of 056) (c) not all mandatory fields are populated (response code of 018) (d) not received at least one Business Day prior to SNA expiry (response code of 032)
	Outcomes and Actions				
19	Send SNA Withdrawal Confirmation/ Rejection	L	D	Utilised to notify confirmation or rejection of a SNA Withdrawal Notification made by the Gaining C/CSP.	Losing C/CSP sends SNA Withdrawal Confirmation/Rejection within one Business Day of receipt of the SNA Withdrawal Notification
	Outcomes and Actions			Losing C/CSP sends SNA Withdrawal Confirmation/Rejection within one Business Day of receipt of the SNA Withdrawal Notification Confirmations will cancel the SNA	
20	Receive SNA Withdrawal Confirmation/ Rejection	G	D		
	Outcomes and Actions			Rejection Internal operational process	

CAT. A – Donor as Losing C/CSP					
Legend for C/CSP: G is for Gaining C/CSP L is for Losing C/CSP D is for Donor C/CSP			Legend for File: D is for Daily PNO H is for Hot Batch		
REF	Event	C/CSP	File	Description	Rules
21	Send SNA Expiry Notification	L	D	Utilised to notify the Gaining C/CSP that the valid period for the SNA has expired and hence deemed to be cancelled	Any SNA that exceeds its SNA expiry date will have an SNA Expiry Notification sent to the Gaining C/CSP one Business Day after the expiry date. Losing C/CSP cancels the SNA
	Outcomes and Actions			Any SNA that exceeds its SNA expiry date will have an SNA Expiry Notification sent to the Gaining C/CSP one Business Day after the expiry date The SNA is no longer valid.	
22	Receive SNA Expiry Notification	G	D		
	Outcomes and Actions			Internal operational process	

CAT. A – Donor as Gaining C/CSP					
Legend for C/CSP: G is for Gaining C/CSP L is for Losing C/CSP D is for Donor C/CSP			Legend for File: D is for Daily PNO H is for Hot Batch		
REF	Event	C/CSP Role	File	Description	Rules
3 cont					<p>A product i.e. Portable within two Business Days of receipt of the SNA (response code of 005)</p> <p>(j) the Telephone Number is in the process of being Ported (response code of 008)</p> <p>(k) the Telephone Number is pending disconnection (response code of 004)</p> <p>(l) the CA date is more than 90 calendar days from receipt of the SNA (response code of 067)</p> <p>(m) category type not defined and no valid association to record type ie. 002 is for Cat A (response code of 063)</p> <p>(n) not all mandatory fields are populated (response code of 018)</p> <p>(o) network based diversion (eg. network service only) (response code of 002)</p>
	Outcomes and Actions				
4	Send SNA Confirmation/ Rejection	L	D	Utilised to notify the confirmation or rejection of a SNA made by the Gaining C/CSP.	Losing C/CSP must send SNA Confirmation/Rejection within one Business Day of receipt of the SNA
	Outcomes and Actions			<p>Confirmation Confirmation of the SNA will make the Port active. The expiry date for a confirmed SNA will be set 30 days from receipt of the notification (inclusive)</p> <p>Rejection Rejection of the SNA will not make the SNA active</p>	
5	Receive SNA Confirmation	G	D		
	Outcomes and Actions			<p>Confirmation Confirmation of the SNA will make the Port active. The expiry date for a confirmed SNA will be set 30 days from receipt of the notification (inclusive)</p> <p>The Cutover must not be requested within two</p>	

CAT. A – Donor as Gaining C/CSP					
Legend for C/CSP: G is for Gaining C/CSP L is for Losing C/CSP D is for Donor C/CSP			Legend for File: D is for Daily PNO H is for Hot Batch		
REF	Event	C/CSP Role	File	Description	Rules
				Business Days of the SNA. The Cutover should be requested within 30 calendar days of the SNA unless Retargeted.	
6	Receive SNA Rejection	G	D		
	Outcomes and Actions			Rejection Internal operational process. Update the Ported Local Number Register	
7	Update Ported Local Number Register	G/D	N/A		The update of the PLNR will replace the existing indicator either “D” or “E” with a new indicator of “F” for the entry for the Telephone Number. The next update of the PLNR will remove the indicator “F” from the entry for the Telephone Number.
	Outcomes and Actions			Ported Local Number Register updated	
8	Send ECA Cutover Notification	G	H	Utilised to notify the Losing C/CSP that the Cutover can commence on receipt of the ECA Cutover Notification	An ECA Cutover Notification must not be sent prior to the receipt of an SNA Confirmation from the Losing C/CSP.
	Outcomes and Actions				
9	Receive and Validate ECA Cutover Notification	L	H		The Losing C/CSP will be required to validate and reject if: (a) incorrect record format (response code of 020) (b) a confirmed and active SNA does not exist for the Telephone Number for the same Gaining C/CSP (response code of 035) (c) the account number and Telephone Number is not a valid association (response code of 017) (d) not received by the Losing C/CSP within standard hours and days of operations or as otherwise agreed (response code of 034)

CAT. A – Donor as Gaining C/CSP					
Legend for C/CSP: G is for Gaining C/CSP L is for Losing C/CSP D is for Donor C/CSP			Legend for File: D is for Daily PNO H is for Hot Batch		
REF	Event	C/CSP Role	File	Description	Rules
9 cont					(e) not a minimum two Business Days from receipt of the SNA (response code of 032) (f) not all mandatory fields are populated (response code of 018)
	Outcomes and Actions			Confirmation Implement Cutover. Activation Targets apply. Rejection No change to Port status	
10	Send ECA Cutover Confirmation/ Rejection	L	H	Utilised to notify confirmation or rejection of an ECA Cutover Notification made by the Gaining C/CSP.	Losing C/CSP must send an ECA Cutover Confirmation/Rejection within 15 minutes of receipt of the ECA Cutover Notification
	Outcomes and Actions			ECA Cutover Confirmation/Rejections will be sent in standard operational hours or as otherwise agreed if the ECA was received within agreed Business Days and hours of operations.	
11	Receive ECA Cutover Confirmation/ Rejection	G	H		
	Outcomes and Actions			Confirmation Implement Cutover. Rejection Internal operational process	
12	Completion of the Cutover	L	N/A		
	Outcomes and Actions			Completed Cutover will cause an SNA Completion Notification to be sent to the Gaining C/CSP within 15 minutes of Cutover	
13	Send SNA Completion Notification	L	H	Utilised to notify the Gaining C/CSP of the completion of the Port.	Completions will be batched and sent to the Gaining C/CSP at least every 15 minutes.
	Outcomes and Actions				

CAT. A – Donor as Gaining C/CSP					
Legend for C/CSP: G is for Gaining C/CSP L is for Losing C/CSP D is for Donor C/CSP			Legend for File: D is for Daily PNO H is for Hot Batch		
REF	Event	C/CSP Role	File	Description	Rules
14	Receive SNA Completion Notification	G	H		
	Outcomes and Actions				
15	Update Ported Local Number Register	G/D	N/A	The PLNR is only updated following the end of the Reversal Period.	The update of the PLNR will replace the existing indicator either "D" or "E" with a new indicator of "C". The next update of the PLNR will remove the entry from the PLNR.
	Outcomes and Actions			Ported Local Number Register updated	
16	Update Ported Local Number Register	G/D	N/A	If a Reversal is called, the PLNR is updated to indicate that the Port is no longer pending.	The update of the PLNR will replace the existing indicator either "D" or "E" with a new indicator of "F". The next update of the PLNR will remove the indicator of "F" from the entry.
	Outcomes and Actions			Ported Local Number Register updated	
17	Send SNA Retarget Notification	G	D	Utilised to extend the valid period of the SNA Port Notification by another thirty days from receipt of the SNA Retarget Notification	
	Outcomes and Actions				
18	Receive and Validate SNA Retarget Notification	L	D		Losing C/CSP shall validate and reject if: (a) incorrect record format (response code of 020) (b) a confirmed and active SNA Port Notification does not exist for the Telephone Number for the same Gaining C/CSP (response code of 057) (c) SNA Port Notification exceeds two confirmed Retargets in total (response code of 037) (d) not all mandatory fields are populated (response code of 018) (e) not received at least one Business Day prior to expiry of SNA (response code of 032)
	Outcomes and Actions				

CAT. A – Donor as Gaining C/CSP					
Legend for C/CSP: G is for Gaining C/CSP L is for Losing C/CSP D is for Donor C/CSP			Legend for File: D is for Daily PNO H is for Hot Batch		
REF	Event	C/CSP Role	File	Description	Rules
19	Send SNA Retarget Confirmation/ Rejection	L	D	Utilised to notify the confirmation or rejection of a SNA Retarget Notification made by the Gaining C/CSP.	Losing C/CSP sends SNA Retarget Confirmation/Rejection within one Business Day of receipt of the SNA Retarget Notification
	Outcomes and Actions			Losing C/CSP sends SNA Retarget Confirmation/Rejection within one Business Day of receipt of the SNA Retarget Notification Confirmations will cause the expiry date to be moved 30 calendar days forward from the receipt of the SNA Retarget Notification.	
20	Receive SNA Retarget Confirmation/ Rejection	G	D		
	Outcomes and Actions			Rejection Internal operational process	
21	Send SNA Withdrawal Notification	G	D	Utilised to notify the Losing C/CSP of a withdrawal of the original SNA made by the Gaining C/CSP.	
	Outcomes and Actions				
22	Update Ported Local Number Register	G/D	N/A		The update of the PLNR will replace the existing indicator either "D" or "E" with a new indicator of "F" for the entry for the Telephone Number. The next update of the PLNR will remove the indicator "F" from the entry for the Telephone Number.
	Outcomes and Actions			Ported Local Number Register updated	
23	Receive and Validate SNA Withdrawal Notification	L	D		Losing C/CSP shall validate and reject if: (a) incorrect record format (response code of 020) (b) a confirmed and active SNA does not exist for the Telephone Number for the same Gaining C/CSP (response code of 056)

CAT. A – Donor as Gaining C/CSP					
Legend for C/CSP: G is for Gaining C/CSP L is for Losing C/CSP D is for Donor C/CSP			Legend for File: D is for Daily PNO H is for Hot Batch		
REF	Event	C/CSP Role	File	Description	Rules
23 cont					(c) not all mandatory fields are populated (response code of 018) (d) not received at least one Business Day prior to SNA expiry (response code of 032)
	Outcomes and Actions				
24	Send SNA Withdrawal Confirmation/ Rejection	L	D	Utilised to notify confirmation or rejection of a SNA Withdrawal Notification made by the Gaining C/CSP.	Losing C/CSP sends SNA Withdrawal Confirmation/Rejection within one Business Day of receipt of the SNA Withdrawal Notification
	Outcomes and Actions			Losing C/CSP sends SNA Withdrawal Confirmation/Rejection within one Business Day of receipt of the SNA Withdrawal Notification Confirmations will cancel the SNA	
25	Receive SNA Withdrawal Confirmation/ Rejection	G	D		
	Outcomes and Actions			Rejection Internal operational process	
26	Send SNA Expiry Notification	L	D	Utilised to notify the Gaining C/CSP that the valid period for the SNA has expired and hence deemed to be cancelled	Any SNA that exceeds its SNA expiry date will have an SNA Expiry Notification sent to the Gaining C/CSP one Business Day after the expiry date Losing C/CSP cancels the SNA
	Outcomes and Actions			Any SNA that exceeds its SNA expiry date will have an SNA Expiry Notification sent to the gaining C/CSP one Business Day after the expiry date The SNA is no longer valid.	
27	Receive SNA Expiry Notification	G	D		
	Outcomes			Internal operational	

CAT. A – Donor as Gaining C/CSP					
Legend for C/CSP: G is for Gaining C/CSP L is for Losing C/CSP D is for Donor C/CSP			Legend for File: D is for Daily PNO H is for Hot Batch		
REF	Event	C/CSP Role	File	Description	Rules
	and Actions			process Update Ported Local Number Register	
28	Update Ported Local Number Register	G/D	N/A		The update of the PLNR will replace the existing indicator either "D" or "E" with a new indicator of "F" for the entry for the Telephone Number. The next update of the PLNR will remove the indicator "F" from the entry for the Telephone Number.
	Outcomes and Actions			Ported Local Number Register updated	

5.3 Cat. A – Third Party

CAT. A – Third Party Legend for C/CSP: G is for Gaining C/CSP L is for Losing C/CSP D is for Donor C/CSP Legend for File: D is for Daily PNO H is for Hot Batch					
REF	Event	C/CSP Role	File	Description	Rules
1	Create and Send an SNA to Losing C/CSP	G	D	Utilised to notify the Losing C/CSP of a Telephone Number being Ported to another C/CSP.	
	Outcomes and Actions			SNA included in daily PNO file for forwarding to Losing C/CSP	
2	Receive and Validate SNA	L	D		Losing C/CSP shall validate and reject if: <ul style="list-style-type: none"> (a) incorrect record format (response code of 020) (b) Telephone Number not found (response code of 001) (c) Telephone Number already Ported to the Gaining C/CSP (response code of 009) (d) the Telephone Number is not Ported to Losing C/CSP (response code of 010) (e) Telephone Number is owned and utilised by the Losing C/CSP i.e. test service (response code of 011) (f) the Telephone Number is not active or reserved (response code of 003) (g) Telephone Number is not associated to the appropriate exchange technology that supports the Porting of Telephone Numbers (response code of 015) (h) the Telephone Number and account number provided is not a valid association (response code of 017) (i) the product associated to the Telephone Number is not a Cat A product ie. Portable within two Business Days of receipt of the SNA Port Notification (response code of 005) (j) the Telephone Number is in the process of being Ported (response code of 008)the Telephone Number is pending disconnection (response code of 004)

CAT. A – Third Party					
Legend for C/CSP: G is for Gaining C/CSP L is for Losing C/CSP D is for Donor C/CSP			Legend for File: D is for Daily PNO H is for Hot Batch		
REF	Event	C/CSP Role	File	Description	Rules
2 cont					(k) the CA date is more than 90 calendar days from receipt of the SNA Port Notification (response code of 067) (l) category type not defined and no valid association to the record type ie. 002 is for a Cat A process (response code of 063) (m) not all mandatory fields are populated (response code of 018) (n) network based diversion (eg. network service only) (response code of 002)
	Outcomes and Actions				
3	Send SNA Confirmation/ Rejection	L	D	Utilised to notify the confirmation or rejection of a SNA made by the Gaining C/CSP.	Losing C/CSP must send an SNA Confirmation/Rejection within one Business Day of receipt of the SNA
	Outcomes and Actions			Confirmation of the SNA will make the Port active. The expiry date for a confirmed SNA will be set 30 days from receipt of the notification (inclusive) Rejection of the SNA will not make the SNA active	
4	Receive SNA Confirmation/ Rejection	G	D		
	Outcomes and Actions			Confirmation Confirmation of the SNA will make the Port active. The expiry date for a confirmed SNA will be set 30 days from receipt of the notification (inclusive) The Cutover must not be requested within two Business Days of the SNA. The Cutover should be requested within 30 calendar days of the SNA unless Retargeted. Rejection Internal operational process	

CAT. A – Third Party					
Legend for C/CSP: G is for Gaining C/CSP L is for Losing C/CSP D is for Donor C/CSP			Legend for File: D is for Daily PNO H is for Hot Batch		
REF	Event	C/CSP Role	File	Description	Rules
5	Create and Send a TSNA Port Notification to Donor C/CSP	G	D	Utilised to notify the Donor C/CSP of a Telephone Number being moved to another C/CSP.	
	Outcomes and Actions			TSNA included in daily PNO file for forwarding to Donor C/CSP	
6	Receive and Validate TSNA	D	D		Donor C/CSP shall validate and reject if: (a) incorrect record format (response code of 020) (b) the Telephone Number is not allocated to the Donor (response code of 069) (c) the Telephone Number is not in a completed Ported state (response code of 052) (d) the Telephone Number is in the process of being Ported to another C/CSP (response code of 051) (e) the Telephone Number is in the process of being Ported to the Gaining C/CSP (response code of 008) (f) the Telephone Number is already Ported to the Gaining C/CSP (response code of 009) (g) not all mandatory fields are populated (response code of 018)
	Outcomes and Actions				
7	Send TSNA Confirmation/Rejection	D	D	Utilised to notify the confirmation or rejection of a TSNA made by the Gaining C/CSP.	Donor C/CSP must send TSNA Confirmation/Rejection within one Business Day of receipt of the TSNA Port Notification
	Outcomes and Actions			The expiry date for a confirmed TSNA will be set to 90 days from receipt of the notification (inclusive) Confirmations will make the TSNA active. Update the Ported Local Number Register Rejections will not make the TSNA active	

CAT. A – Third Party					
Legend for C/CSP: G is for Gaining C/CSP L is for Losing C/CSP D is for Donor C/CSP			Legend for File: D is for Daily PNO H is for Hot Batch		
REF	Event	C/CSP Role	File	Description	Rules
8	Update Ported Local Number Register	D	N/A		The update of the PLNR for the Telephone Number will add the indicator "D" to the entry for the Telephone Number. The next update of the PLNR will replace the indicator "D" with a new indicator of "E" for the entry for the Telephone Number.
	Outcomes and Actions			Ported Local Number Register updated	
9	Receive TSNA Confirmation/ Rejection	G	D		
	Outcomes and Actions			<p>Confirmation</p> <p>Confirmation of the TSNA will make the Port active.</p> <p>The expiry date for a confirmed TSNA will be set to 90 days from receipt of the notification (inclusive)</p> <p>The Cutover must not be requested within two Business Days of the TSNA.</p> <p>The Cutover should be requested within 90 calendar days of the TSNA.</p> <p>Rejection</p> <p>Internal operational process</p>	
10	Send TECA Cutover Notification to Donor C/CSP	G	H	Utilised to notify the Donor C/CSP that the cutover can commence on receipt of the TECA Cutover Notification	A TECA Cutover Notification must not be sent prior to the receipt of an TSNA Confirmation from the Donor C/CSP.
	Outcomes and Actions				
11	Receive and Validate TECA Cutover Notification	D	H		The Donor C/CSP shall validate and reject if: (a) incorrect record format (response code of 020) (b) a confirmed and active TSNA does not exist for the Telephone Number for the same Gaining C/CSP (response code of 035)

CAT. A – Third Party					
Legend for C/CSP: G is for Gaining C/CSP L is for Losing C/CSP D is for Donor C/CSP			Legend for File: D is for Daily PNO H is for Hot Batch		
REF	Event	C/CSP Role	File	Description	Rules
11 cont					(c) not received by the Donor C/CSP within standard hours and days of operations or as otherwise agreed (response code of 034) (d) not a minimum of two Business Days from receipt of the TSNA(response code of 032) (e) not all mandatory fields are populated (response code of 018)
	Outcomes and Actions				
12	Send TECA Cutover Confirmation/ Rejection	D	H	Utilised to notify confirmation or rejection of a TECA Cutover Notification made by the Gaining C/CSP.	Donor C/CSP sends TECA Cutover Confirmation/Rejection within 15 minutes of receipt of the TECA Cutover Notification
	Outcomes and Actions			TECA Cutover Confirmation/Rejections will be sent in standard hours of operations or as otherwise agreed if the TECA Cutover Notification was received within agreed Business Days and hours of operation	
13	Receive TECA Cutover Confirmation/ Rejection	L	H		
	Outcomes and Actions			Confirmation Implement Transfer Rejection Internal operational process	
14	Completion of the Transfer	D	N/A		
	Outcomes and Actions			Completed Transfer will cause a TSNA Completion Notification to be sent to the Gaining C/CSP within 15 minutes of Transfer.	
15	Send TSNA Completion Notification	D	H	Utilised to notify the Gaining C/CSP of a completion of the transfer.	
	Outcomes and Actions				

CAT. A – Third Party					
Legend for C/CSP: G is for Gaining C/CSP L is for Losing C/CSP D is for Donor C/CSP			Legend for File: D is for Daily PNO H is for Hot Batch		
REF	Event	C/CSP Role	File	Description	Rules
16	Update Ported Local Number Register	D	N/A	The PLNR is updated following the end of the Transfer Reversal Period.	If a Transfer Reversal is not called, the update of the PLNR will replace the existing C/CSP code with the new C/CSP code and change the indicator to "B" for the entry for the Telephone Number. The next update of the PLNR will remove the indicator "B" from the entry for the Telephone Number from the PLNR.
	Outcomes and Actions			Ported Local Number Register updated	
17	Update Ported Local Number Register	D	N/A	If a Transfer Reversal is called, the PLNR is updated to indicate that the Port is no longer pending.	If a Transfer Reversal is called the update of the PLNR will replace the existing indicator of either "D" or "E" with a new indicator of "F". The next update of the PLNR will remove the indicator of "F" from the entry.
	Outcomes and Actions			Ported Local Number Register updated	
18	Receive TSNA Completion Notification	G	H		
	Outcomes and Actions				
18	Send ECA Cutover Notification to Losing C/CSP	G	H	Utilised to notify the Losing C/CSP that the cutover can commence on receipt of the ECA Cutover Notification	
	Outcomes and Actions				
19	Receive and Validate ECA Cutover Notification	L	H		The Losing C/CSP will be required to validate and reject if: (a) incorrect record format (response code of 020) (b) a confirmed and active SNA does not exist for the Telephone Number for the same Gaining C/CSP (response code of 035) (c) the account number and Telephone Number is not a valid association (response code of 017) (d) the ECA Cutover Notification is not received by the Losing C/CSP within standard hours and days of operations or as

CAT. A – Third Party					
Legend for C/CSP: G is for Gaining C/CSP L is for Losing C/CSP D is for Donor C/CSP			Legend for File: D is for Daily PNO H is for Hot Batch		
REF	Event	C/CSP Role	File	Description	Rules
19 cont					otherwise agreed (response code of 034) (e) the ECA Cutover Notification is not a minimum of two Business Days from receipt of the SNA (response code of 032) (f) not all mandatory fields are populated (response code of 018)
	Outcomes and Actions			Confirmation Implement Cutover. Activation targets apply. Rejection No change to Port status.	
20	Send ECA Cutover Confirmation/ Rejection	L	H	Utilised to notify confirmation or rejection of an ECA Cutover Notification made by the Gaining C/CSP.	Losing C/CSP must send an ECA Cutover Confirmation/Rejection within 15 minutes of receipt of the ECA Cutover Notification
	Outcomes and Actions			ECA Cutover Confirmation/Rejections will be sent in standard operational hours or as otherwise agreed if the ECA Cutover Notification was received within agreed Business Days and hours of operation	
21	Receive ECA Cutover Confirmation/ Rejection	G	H		
	Outcomes and Actions			Confirmation Implement Cutover Rejection Internal operational process	
22	Completion of the Cutover	L	N/A		
	Outcomes and Actions			Completed Cutover will cause an SNA Completion Notification to be sent to the Gaining C/CSP within 15 minutes of Cutover.	
23	Send SNA Completion Notification	L	H	Utilised to notify the Gaining C/CSP of the completion of the Port.	

CAT. A – Third Party					
Legend for C/CSP: G is for Gaining C/CSP L is for Losing C/CSP D is for Donor C/CSP			Legend for File: D is for Daily PNO H is for Hot Batch		
REF	Event	C/CSP Role	File	Description	Rules
	Outcomes and Actions				
24	Receive SNA Completion Notification	G	H		
	Outcomes and Actions				
25	Send SNA Retarget Notification	G	D	Utilised to extend the valid period of the SNA by another thirty days from receipt of the SNA Retarget Notification	
	Outcomes and Actions				
26	Receive and Validate SNA Retarget Notification	L	D		Losing C/CSP shall validate and reject if: (a) incorrect record format (response code of 020) (b) a confirmed and active SNA does not exist for the Telephone Number for the same Gaining C/CSP (response code of 057) (c) SNA Retarget Notification does exceed two confirmed Retargets in total (response code of 037) (d) not all mandatory fields are populated (response code of 0182) (e) not received at least one Business Day prior to expiry of the SNA (response code of 032)
	Outcomes and Actions				
27	Send SNA Retarget Confirmation/ Rejection	L	D	Utilised to notify the confirmation or rejection of a SNA Retarget Notification made by the Gaining C/CSP.	Losing C/CSP sends SNA Retarget Confirmation/Rejection within one Business Day of receipt of the SNA Retarget Notification
	Outcomes and Actions			Losing C/CSP sends SNA Retarget Confirmation/Rejection within one Business Day of receipt of the SNA Retarget Notification Confirmations will cause the expiry date to be moved 30 calendar days forward from the receipt of the SNA Retarget Notification.	

CAT. A – Third Party					
Legend for C/CSP: G is for Gaining C/CSP L is for Losing C/CSP D is for Donor C/CSP			Legend for File: D is for Daily PNO H is for Hot Batch		
REF	Event	C/CSP Role	File	Description	Rules
28	Receive SNA Retarget Confirmation/ Rejection	G	D		
	Outcomes and Actions			Rejection Internal operational process	
29	Send TSNA Withdrawal Notification	G	D	Utilised to notify the Donor C/CSP of a withdrawal of the original TSNA made by the Gaining C/CSP.	
	Outcomes and Actions				
30	Receive and Validate TSNA Withdrawal Notification	D	D		Donor C/CSP shall validate and reject if: (a) incorrect record format (response code of 020) (b) a confirmed and active TSNA does not exist for the Telephone Number for the same Gaining C/CSP (response code of 056) (c) not all mandatory fields are populated (response code of 018) (d) not received at least one Business Day prior to TSNA expiry (response code of 032)
	Outcomes and Actions				
31	Send TSNA Withdrawal Confirmation/ Rejection	D	D	Utilised to notify confirmation or rejection of a TSNA Withdrawal Notification made by the Gaining C/CSP.	Donor C/CSP sends TSNA Withdrawal Confirmation/Rejection within one Business Day of receipt of the TSNA Withdrawal Notification
	Outcomes and Actions			Donor C/CSP sends TSNA Withdrawal Confirmation/Rejection within one Business Day of receipt of the TSNA Withdrawal Notification Confirmations will cancel the TSNA Update Ported Local Number Register	

CAT. A – Third Party					
Legend for C/CSP: G is for Gaining C/CSP L is for Losing C/CSP D is for Donor C/CSP			Legend for File: D is for Daily PNO H is for Hot Batch		
REF	Event	C/CSP Role	File	Description	Rules
32	Update Ported Local Number Register	D	N/A		The update of the PLNR will replace the existing indicator either "D" or "E" with a new indicator of "F" for the entry for the Telephone Number. The next update of the PLNR will remove the indicator "F" from the entry for the Telephone Number.
	Outcomes and Actions			Ported Local Number Register updated	
33	Send SNA Withdrawal Notification	G	D	Utilised to notify the Losing C/CSP of a withdrawal of the original SNA made by the Gaining C/CSP.	
	Outcomes and Actions				
34	Receive and Validate SNA Withdrawal Notification	L	D		Losing C/CSP shall validate and reject if: (a) incorrect record format (response code of 020) (b) a confirmed and active SNA Port Notification does not exist for the Telephone Number for the same Gaining C/CSP (response code of 056) (c) not all mandatory fields are populated (response code of 018) (d) not received at least one Business Day prior to SNA expiry (response code of 032)
	Outcomes and Actions				
35	Send SNA Withdrawal Confirmation/ Rejection	L	D	Utilised to notify confirmation or rejection of a SNA Withdrawal Notification made by the Gaining C/CSP.	Losing C/CSP sends SNA Withdrawal Confirmation/Rejection within one Business Day of receipt of the SNA Withdrawal Notification
	Outcomes and Actions			Losing C/CSP sends SNA Withdrawal Confirmation/Rejection within one Business Day of receipt of the SNA Withdrawal Notification Confirmations will cancel the SNA	
36	Receive SNA Withdrawal Confirmation/ Rejection	G	D		

CAT. A – Third Party					
Legend for C/CSP: G is for Gaining C/CSP L is for Losing C/CSP D is for Donor C/CSP			Legend for File: D is for Daily PNO H is for Hot Batch		
REF	Event	C/CSP Role	File	Description	Rules
	Outcomes and Actions			Rejection Internal operational process	
37	Send SNA Expiry Notification	L	D	Utilised to notify the Gaining C/CSP that the valid period for the SNA has expired and hence deemed to be cancelled	Any SNA that exceeds its SNA expiry date will have an SNA Expiry Notification sent to the Gaining C/CSP one Business Day after the expiry date Losing C/CSP cancels the SNA
	Outcomes and Actions			Any SNA that exceeds its SNA expiry date will have an SNA Expiry Notification sent to the Gaining C/CSP one Business Day after the expiry date The SNA is no longer valid.	
38	Receive SNA Expiry Notification	G	D		
	Outcomes and Actions			Internal operational process	
39	Send TSNA Expiry Notification	D	D	Utilised to notify the Gaining C/CSP that the valid period for the TSNA has expired and hence deemed to be cancelled	Any TSNA that exceeds its TSNA expiry date will have a TSNA Expiry Notification sent to the Gaining C/CSP one Business Day after the expiry date Donor C/CSP cancels the TSNA
	Outcomes and Actions			Any TSNA that exceeds its TSNA expiry date will have a TSNA Expiry Notification sent to the Gaining C/CSP one Business Day after the expiry date The TSNA is no longer valid.	
40	Update Ported Local Number Register	D	N/A		The update of the PLNR will replace the existing indicator either "D" or "E" with a new indicator of "F" for the entry for the Telephone Number. The next update of the PLNR will remove the indicator "F" from the entry for the Telephone Number.
	Outcomes and Actions			Ported Local Number Register updated	

CAT. A – Third Party					
Legend for C/CSP: G is for Gaining C/CSP L is for Losing C/CSP D is for Donor C/CSP			Legend for File: D is for Daily PNO H is for Hot Batch		
REF	Event	C/CSP Role	File	Description	Rules
41	Receive TSNA Expiry Notification	G	D		
	Outcomes and Actions			Internal operational process	

6 CAT. A - THIRD PARTY PORT ACTIVITY

Third Party Porting requires the Gaining C/CSP to carefully co-ordinate activities with both the Donor C/CSP and the Losing C/CSP. The tables below provide guidance in the activity that can occur in various Porting scenarios.

6.1 SNA/TSNA Initiated

Losing C/CSP Response	Donor Response	Port Still Proceeding	Port Not Proceeding	No Action by Gaining C/CSP
SNA Rejected	TSNA Rejected	Issue new SNA and TSNA	No action required	N/A
SNA Confirmed	TSNA Rejected	Issue new TSNA	Issue SNA Withdrawal or allow SNA to Expire	SNA will expire
SNA Rejected	TSNA Confirmed	Issue new SNA	Issue TSNA Withdrawal or allow TSNA to Expire	TSNA will expire
SNA Confirmed	TSNA Confirmed	Issue ECA & TECA	Issue SNA Withdrawal & TSNA Withdrawal or allow Port to Expire	SNA & TSNA will expire

6.2 Port Cutover

Losing C/CSP Response	Donor Response	Port Still Proceeding	Port Not Proceeding	No Action by Gaining C/CSP
ECA Rejected	TECA Rejected	Issue new ECA & new TECA	Issue SNA & TSNA Withdrawal or allow Port to Expire	SNA & TSNA will expire
ECA Confirmed	TECA Rejected	Issue new TECA	Undertake Reversal with Losing C/CSP. Also issue a Withdrawal of TSNA or allow TSNA to Expire	Port from Losing C/CSP completed and no transfer from Donor C/CSP
ECA Rejected	TECA Confirmed	Issue new ECA	Undertake Transfer Reversal with the Donor. Issue a Withdrawal of SNA or allow SNA to Expire	Transfer from Losing C/CSP completed and no Port from Losing C/CSP

Losing C/CSP Response	Donor Response	Port Still Proceeding	Port Not Proceeding	No Action by Gaining C/CSP
ECA Confirmed	TECA Confirmed	No further action required	Undertake Transfer Reversal with Donor and Reversal with the Losing C/CSP	Port completed

6.3 SNA/TSNA Retarget

Losing C/CSP Response	Donor Response	Port Still Proceeding	Port Not Proceeding	No Action by Gaining C/CSP
SNA Retarget Rejected	N/A	Issue new SNA Retarget, if required.	Issue SNA Withdrawal and TSNA Withdrawal or allow SNA and TSNA to expire.	SNA & TSNA will expire
SNA Retarget Confirmed	N/A	Issue ECA & TECA	Issue SNA Withdrawal and TSNA Withdrawal or allow SNA and TSNA to expire.	SNA & TSNA will expire

6.4 SNA/TSNA Withdrawal

Losing C/CSP Response	Donor Response	Port Still Proceeding	Port Not Proceeding	No Action by Gaining C/CSP
SNA Withdrawal Rejected	TSNA Withdrawal Rejected	No further action required	Issue new SNA Withdrawal & TSNA Withdrawal or allow Port to Expire	SNA & TSNA will expire
SNA Withdrawal Confirmed	TSNA Withdrawal Rejected	Issue new SNA	Issue new TSNA Withdrawal or allow Port to Expire	TSNA will expire
SNA Withdrawal Rejected	TSNA Withdrawal Confirmed	Issue new TSNA	Issue new SNA Withdrawal or allow Port to Expire	SNA will expire
SNA Withdrawal Confirmed	TSNA Withdrawal Confirmed	Issue new SNA and TSNA	No further action required	N/A

6.5 Port Expiry

Losing C/CSP Response	Donor Response	Port Still Proceeding	Port Not Proceeding	No Action by Gaining C/CSP
SNA Expired	TSNA Expired	Issue new SNA and TSNA	No further action required	N/A
SNA Active	TSNA Expired	Issue new TSNA	Issue SNA Withdrawal or allow SNA to Expire	SNA will expire
SNA Expired	TSNA Active	Issue new SNA	Issue TSNA Withdrawal or allow TSNA to Expire	TSNA will expire
SNA Active	TSNA Active	Issue ECA & TECA	Issue SNA Withdrawal & TSNA Withdrawal or allow Port to Expire	SNA & TSNA will expire

7 CAT. A - PORTING TIME FRAMES

	Confirmation/ Reject	Receipt Advice	Limit (for confirmations)	Completion	Expiry	Comments
Customer Authorisation	N/A	N/A	N/A	N/A	90 Calendar Days	
SNA (A)	One Business Day	N/A	One		30 Calendar Days	SNA must be forwarded at least two Business Days prior to the Cutover (ECA)
SNA Retarget (A)	One Business Day	N/A	Two	N/A	SNA Expiry + 30 Calendar Days	Must be provided up to one Clear Business Day prior to the Expiry Date
SNA Withdrawal (A)	One Business Day	N/A	One	N/A	N/A	Must be provided up to one Clear Business Day prior to the Expiry Date and before the ECA
ECA (A)	15 Minutes	N/A	One	15 Minutes	N/A	ECA must be received at least two Business Days after the SNA is received
TSNA (A)	One Business Day	N/A	One		90 Calendar Days	TSNA must be forwarded at least two Business Days prior to the Cutover (TECA)
TSNA Withdrawal (A)	One Business Day	N/A	One	N/A	N/A	Must be provided up to one Business Day prior to the Expiry Date and before the TECA
TECA (A)	15 Minutes	N/A	One	15 Minutes	N/A	TECA must be received at least two Business Days after the TSNA is received
Giveback	N/A	N/A	One	N/A	N/A	Giveback advice to be provided within two Business Days of the cancellation of the service associated with that Telephone Number.

8 CAT. A – RECORD DESCRIPTION

8.1 SNA

Attribute Name	Data Type	Start	Finish	Value	Mandatory	Description
Record Version	NUM(2)	1	2	01	Y	
Record Type	NUM(3)	3	5	002	Y	
Record Identifier	CHAR(3)	6	8	REQ	Y	
Category Type	CHAR(1)	9	9	A	Y	
Telephone Number	NUM(10)	10	19		Y	Full National Number e.g. 0396342223
Reference	CHAR(9)	20	28		N	Default value is spaces
Account Number	CHAR(25)	29	53		Y	Value other than spaces The Account Number which the Losing C/CSP uses for the aggregation of services for a customer for the purpose of billing the customer.
CA Date	DATE(8)	54	61		Y	Format CCYYMMDD
Filler	CHAR(189)	62	250			

8.2 SNA Confirmation

Attribute Name	Data Type	Start	Finish	Value	Mandatory	Description
Record Version	NUM(2)	1	2	01	Y	
Record Type	NUM(3)	3	5	002	Y	
Record Identifier	CHAR(3)	6	8	RSP	Y	
Telephone Number	NUM(10)	9	18		Y	Full National Number e.g. 0396342223
Reference	CHAR(9)	19	27		N	Default value is spaces
Response Code	NUM(3)	28	30	000	Y	
Filler	CHAR(220)	31	250			

8.3 SNA Rejection

Attribute Name	Data Type	Start	Finish	Value	Mandatory	Description
Record Version	NUM(2)	1	2	01	Y	
Record Type	NUM(3)	3	5	002	Y	
Record Identifier	CHAR(3)	6	8	RSP	Y	
Telephone Number	NUM(10)	9	18		Y	Full National Number e.g. 0396342223
Reference	CHAR(9)	19	27		N	Default value is spaces

Attribute Name	Data Type	Start	Finish	Value	Mandatory	Description
Response Code	NUM(3)	28	30		Y	Must be a valid Code from Section 1
Filler	CHAR(220)	31	250			

8.4 SNA Retarget Notification

Attribute Name	Data Type	Start	Finish	Value	Mandatory	Description
Record Version	NUM(2)	1	2	01	Y	
Record Type	NUM(3)	3	5	003	Y	
Record Identifier	CHAR(3)	6	8	REQ	Y	
Telephone	CHAR(10)	9	18		Y	Full National Number e.g. 0396342223
Reference	CHAR(9)	19	27		N	Default value is spaces
Filler	CHAR(223)	28	250			

8.5 SNA Retarget Confirmation

Attribute Name	Data Type	Start	Finish	Value	Mandatory	Description
Record Version	NUM(2)	1	2	01	Y	
Record Type	NUM(3)	3	5	003	Y	
Record Identifier	CHAR(3)	6	8	RSP	Y	
Telephone Number	NUM(10)	9	17		Y	Full National Number e.g. 0396342223
Reference	CHAR(9)	19	27		N	Default value is spaces
Response Code	NUM(3)	28	30	000	Y	
Filler	CHAR(220)	31	250			

8.6 SNA Retarget Rejection

Attribute Name	Data Type	Start	Finish	Value	Mandatory	Description
Record Version	NUM(2)	1	2	01	Y	
Record Type	NUM(3)	3	5	003	Y	
Record Identifier	CHAR(3)	6	8	RSP	Y	
Telephone Number	NUM(10)	9	18		Y	Full National Number e.g. 0396342223
Reference	CHAR(9)	19	27		N	Default value is spaces
Response Code	NUM(3)	28	30		Y	Must be a valid Code from Section 1
Filler	CHAR(220)	31	250			

8.7 SNA Withdrawal Notification

Attribute Name	Data Type	Start	Finish	Value	Mandatory	Description
Record Version	NUM(2)	1	2	01	Y	
Record Type	NUM(3)	3	5	004	Y	
Record Identifier	CHAR(3)	6	8	REQ	Y	
Telephone Number	NUM(10)	9	18		Y	Full National Number e.g. 0396342223
Reference	CHAR(9)	19	27		N	Default value is spaces
Filler	CHAR(223)	28	250			

8.8 SNA Withdrawal Confirmation

Attribute Name	Data Type	Start	Finish	Value	Mandatory	Description
Record Version	NUM(2)	1	2	01	Y	
Record Type	NUM(3)	3	5	004	Y	
Record Identifier	CHAR(3)	6	8	RSP	Y	
Telephone Number	NUM(10)	9	18		Y	Full National Number e.g. 0396342223
Reference	CHAR(9)	19	27		N	Default value is spaces
Response Code	NUM(3)	28	30	000	Y	
Filler	CHAR(220)	31	250			

8.9 SNA Withdrawal Rejection

Attribute Name	Data Type	Start	Finish	Value	Mandatory	Description
Record Version	NUM(2)	1	2	01	Y	
Record Type	NUM(3)	3	5	004	Y	
Record Identifier	CHAR(3)	6	8	RSP	Y	
Telephone Number	NUM(10)	9	18		Y	Full National Number e.g. 0396342223
Reference	CHAR(9)	19	27		N	Default value is spaces
Response Code	NUM(3)	28	30		Y	Must be a valid Code from Section 1
Filler	CHAR(220)	31	250			

8.10 ECA Cutover Notification

Attribute Name	Data Type	Start	Finish	Value	Mandatory	Description
Record Version	NUM(2)	1	2	01	Y	
Record Type	NUM(3)	3	5	005	Y	
Record Identifier	CHAR(3)	6	8	REQ	Y	
Account Number	CHAR(25)	9	33		Y	Value other than spaces

Attribute Name	Data Type	Start	Finish	Value	Mandatory	Description
Telephone Number	NUM(10)	34	43		Y	Full National Number e.g. 0396342223
Reference	CHAR(9)	44	52		N	Default value is spaces
Filler	CHAR(8)	53	60			

8.11 ECA Cutover Confirmation

Attribute Name	Data Type	Start	Finish	Value	Mandatory	Description
Record Version	NUM(2)	1	2	01	Y	
Record Type	NUM(3)	3	5	005	Y	
Record Identifier	CHAR(3)	6	8	RSP	Y	
Telephone Number	NUM(10)	9	18		Y	Full National Number e.g. 0396342223
Reference	CHAR(9)	19	27		N	Default value is spaces
Response Code	NUM(3)	28	30	000	Y	
Filler	CHAR(30)	31	60			

8.12 ECA Cutover Rejection

Attribute Name	Data Type	Start	Finish	Value	Mandatory	Description
Record Version	NUM(2)	1	2	01	Y	
Record Type	NUM(3)	3	5	005	Y	
Record Identifier	CHAR(3)	6	8	RSP	Y	
Telephone Number	NUM(10)	9	18		Y	Full National Number e.g. 0396342223
Reference	CHAR(9)	19	27		N	Default value is spaces
Response Code	NUM(3)	28	30		Y	Must be a valid Code from Section 1
Filler	CHAR(30)	31	60			

8.13 SNA Completion Notification

Attribute Name	Data Type	Start	Finish	Value	Mandatory	Description
Record Version	NUM(2)	1	2	01	Y	
Record Type	NUM(3)	3	5	006	Y	
Record Identifier	CHAR(3)	6	8	REQ	Y	
Telephone Number	NUM(10)				Y	Full National Number e.g. 0396342223
Reference	CHAR(9)	19	27		N	Default value is spaces
Filler	CHAR(33)	28	60			

8.14 SNA Expiry Notification

Attribute Name	Data Type	Start	Finish	Value	Mandatory	Description
Record Version	NUM(2)	1	2	01	Y	
Record Type	NUM(3)	3	5	007	Y	
Record Identifier	CHAR(3)	6	8	REQ	Y	
Telephone Number	NUM(10)	9	18		Y	Full National Number e.g. 0396342223
Reference	CHAR(9)	19	27		N	Default value is spaces
Filler	CHAR(223)	28	250			

8.15 TSNA Port Notification

Attribute Name	Data Type	Start	Finish	Value	Mandatory	Description
Record Version	NUM(2)	1	2	01	Y	
Record Type	NUM(3)	3	5	010	Y	
Record Identifier	CHAR(3)	6	8	REQ	Y	
Telephone Number	NUM(10)	9	18		Y	Full National Number e.g. 0396342223
Reference	CHAR(9)	19	27		N	Default value is spaces
Filler	CHAR(223)	28	250			

8.16 TSNA Port Confirmation

Attribute Name	Data Type	Start	Finish	Value	Mandatory	Description
Record Version	NUM(2)	1	2	01	Y	
Record Type	NUM(3)	3	5	010	Y	
Record Identifier	CHAR(3)	6	8	RSP	Y	
Telephone Number	NUM(10)	9	18		Y	Full National Number e.g. 0396342223
Reference	CHAR(9)	19	27		N	Default value is spaces
Response Code	NUM(3)	28	30	000	Y	
Exceed SLA Indicator	CHAR(1)	31	31		N	The value is "Y" if the Cutover may not be completed within the Activation Targets. Default value is a space.
Filler	CHAR(219)	32	250			

8.17 TSNA Port Rejection

Attribute Name	Data Type	Start	Finish	Value	Mandatory	Description
Record Version	NUM(2)	1	2	01	Y	
Record Type	NUM(3)	3	5	010	Y	

Attribute Name	Data Type	Start	Finish	Value	Mandatory	Description
Record Identifier	CHAR(3)	6	8	RSP	Y	
Telephone Number	NUM(10)	9	18		Y	Full National Number e.g. 0396342223
Reference	CHAR(9)	19	27		N	Default value is spaces
Response Code	NUM(3)	28	30		Y	Must be a valid Code from Section 1
Exceed SLA Indicator	CHAR(1)	31	31		N	Must be a space
Filler	CHAR(219)	32	250			

8.18 TSNA Withdrawal Notification

Attribute Name	Data Type	Start	Finish	Value	Mandatory	Description
Record Version	NUM(2)	1	2	01	Y	
Record Type	NUM(3)	3	5	011	Y	
Record Identifier	CHAR(3)	6	8	REQ	Y	
Telephone Number	NUM(10)	9	18		Y	Full National Number e.g. 0396342223
Reference	CHAR(9)	19	27		N	Default value is spaces
Filler	CHAR(223)	28	250			

8.19 TSNA Withdrawal Confirmation

Attribute Name	Data Type	Start	Finish	Value	Mandatory	Description
Record Version	NUM(2)	1	2	01	Y	
Record Type	NUM(3)	3	5	011	Y	
Record Identifier	CHAR(3)	6	8	RSP	Y	
Telephone Number	NUM(10)	9	18		Y	Full National Number e.g. 0396342223
Reference	CHAR(9)	19	27		N	Default value is spaces
Response Code	NUM(3)	28	30	000	Y	
Filler	CHAR(220)	31	250			

8.20 TSNA Withdrawal Rejection

Attribute Name	Data Type	Start	Finish	Value	Mandatory	Description
Record Version	NUM(2)	1	2	01	Y	
Record Type	NUM(3)	3	5	011	Y	
Record Identifier	CHAR(3)	6	8	RSP	Y	
Telephone Number	NUM(10)	9	18		Y	Full National Number e.g. 0396342223

Attribute Name	Data Type	Start	Finish	Value	Mandatory	Description
Reference	CHAR(9)	19	27		N	Default value is spaces
Response Code	NUM(3)	28	30		Y	Must be a valid Code from Section 1
Filler	CHAR(220)	31	250			

8.21 TECA Cutover Notification

Attribute Name	Data Type	Start	Finish	Value	Mandatory	Description
Record Version	NUM(2)	1	2	01	Y	
Record Type	NUM(3)	3	5	012	Y	
Record Identifier	CHAR(3)	6	8	REQ	Y	
Telephone Number	NUM(10)	9	18		Y	Full National Number e.g. 0396342223
Reference	CHAR(9)	19	27		N	Default value is spaces
Filler	CHAR(33)	28	60			

8.22 TECA Cutover Confirmation

Attribute Name	Data Type	Start	Finish	Value	Mandatory	Description
Record Version	NUM(2)	1	2	01	Y	
Record Type	NUM(3)	3	5	012	Y	
Record Identifier	CHAR(3)	6	8	RSP	Y	
Telephone Number	NUM(10)	9	18		Y	Full National Number e.g. 0396342223
Reference	CHAR(9)	19	27		N	Default value is spaces
Response Code	NUM(3)	28	30	000	Y	
Filler	CHAR(30)	31	60			

8.23 TECA Cutover Rejection

Attribute Name	Data Type	Start	Finish	Value	Mandatory	Description
Record Version	NUM(2)	1	2	01	Y	
Record Type	NUM(3)	3	5	012	Y	
Record Identifier	CHAR(3)	6	8	RSP	Y	
Telephone Number	NUM(10)	9	18		Y	Full National Number e.g. 0396342223
Reference	CHAR(9)	19	27		N	Default value is spaces
Response Code	NUM(3)	28	30		Y	Must be a valid Code from Section 1
Filler	CHAR(30)	31	60			

8.24 TSNA Completion Notification

Attribute Name	Data Type	Start	Finish	Value	Mandatory	Description
Record Version	NUM(2)	1	2	01	Y	
Record Type	NUM(3)	3	5	013	Y	
Record Identifier	CHAR(3)	6	8	REQ	Y	
Telephone Number	NUM(10)	9	18		Y	Full National Number e.g. 0396342223
Reference	CHAR(9)	19	27		N	Default value is spaces
Filler	CHAR(33)	28	60			

8.25 TSNA Expiry Notification

Attribute Name	Data Type	Start	Finish	Value	Mandatory	Description
Record Version	NUM(2)	1	2	01	Y	
Record Type	NUM(3)	3	5	014	Y	
Record Identifier	CHAR(3)	6	8	REQ	Y	
Telephone Number	NUM(10)	9	18		Y	Full National Number e.g. 0396342223
Reference	CHAR(9)	19	27		N	Default value is spaces
Filler	CHAR(223)	28	250			

9 CAT. A – RESPONSE CODES

Reject Reason	LNP Reject Description	LNP Further Explanation	SNA	SNA Retarget	SNA Withdrawal	ECA	TSNA	TSNA Withdrawal	TECA
001	Service Number Not Found	Invalid Service / not present on ASD systems	√						
002	Service Number is on Diversion	Service is on Network Based Call Diversion ie. no access line	√						
003	Inactive Service	Service has been Temporarily Disconnected Customer request	√						
004	Disconnected Service	Service is Disconnected or Pending Disconnection	√						
005	Complex Service – eg ISDN, Line Hunt etc.		√				√		
006	ULLS Call Diversion does not exist on requested Telephone Number								
007	ULLS Number/Telephone Number mismatch								
008	Outstanding porting request	Subsequent request rejected	√				√		
009	Porting Already Completed	Porting request received from the current Recipient C/CSP	√				√		
010	Telephone Number Ported to Another ASD	Already Ported	√						
011	ASD Owned Telephone Number	ASD Test Line, etc	√						

Reject Reason	LNP Reject Description	LNP Further Explanation	SNA	SNA Retarget	SNA Withdrawal	ECA	TSNA	TSNA Withdrawal	TECA
012	Not Used								
013	Not Used								
014	Not Used								
015	Incompatible Exchange Technology	Exchange Equipment or Software Version	√						
016	Not Used								
017	Telephone Number / Account Mismatch	Notification or Cutover	√			√			
018	All mandatory fields are not populated	Mandatory data not provided	√	√	√	√	√	√	√
019	Not Used								
020	Transaction Level Rejections	Incorrectly formatted record	√	√	√	√	√	√	√
021	Not Used								
022	Not Used								
023	Not Used								
024	Not Used								
025	Not Used								
026	Not Used								
027	Not Used								

Reject Reason	LNP Reject Description	LNP Further Explanation	SNA	SNA Retarget	SNA Withdrawal	ECA	TSNA	TSNA Withdrawal	TECA
028	Losing C/CSP not the Donor C/CSP	Only applicable for Cat-D							
029	ULL request not completed								
030	ULLS call diversion greater than 30 days	ULLS call diversion greater than 30 days, has expired							
031	Not Used								
032	Insufficient notification time frame	Notification or Cutover		√	√	√		√	√
033	Not Used								
034	Cutover outside agreed hours	Agreed hrs 0700 - 1659				√			√
035	No Porting Request is currently outstanding	Porting Notification is not confirmed or has expired				√			√
036	Invalid Cutover Timeslot								
037	Retarget Limit exceeded	Maximum two Retargets only		√					
038	Giveback Invalid	EG: Not currently Ported							
039	Not Used								
040	Duplicate Telephone Number in Batch	There is a Telephone Number duplicated in a single Batch							
041	Multiple Sites	There are more than one site involved for the Telephone Numbers in a Batch							

Reject Reason	LNP Reject Description	LNP Further Explanation	SNA	SNA Retarget	SNA Withdrawal	ECA	TSNA	TSNA Withdrawal	TECA
042	Not Used								
043	Not Used								
044	Not Used								
045	Not Used								
046	Not Used								
047	Not Used								
048	Not Used								
049	Not Used								
050	Not Used								
051	Telephone Number currently being Ported to another C/CSP						√		
052	Service is currently connected to the ASD's network						√		
053	Cutover Date is within the Lead Time								
054	Cutover Date is outside Expiry Date								
055	Invalid Status - CNA Retarget or Withdrawal requested after CCA was Confirmed								

Reject Reason	LNP Reject Description	LNP Further Explanation	SNA	SNA Retarget	SNA Withdrawal	ECA	TSNA	TSNA Withdrawal	TECA
056	Invalid Withdrawal Request				√			√	
057	Invalid Retarget Request			√					
058	Not Used								
059	Not Used								
060	Incomplete Number Block or missing Telephone Numbers in Batch	Incomplete range / batch of service numbers in complex porting request							
061	Batch Reference Number Missing	Complex porting request received without batch number							
062	Giveback Date Invalid	Future dated							
063	Incorrect Category	Category listed in notification advice is incorrect	√						
064	Secondary Reject	Porting request is valid for Telephone Number but is associated with a primary reject in the same complex batch							
065	Telephone Numbers are not contiguous for a product								
066	Not Used								
067	Invalid CA date	CA date is too old	√						
068	Not Used								
069	Donor reject	Incorrect Donor nominated					√		

Reject Reason	LNP Reject Description	LNP Further Explanation	SNA	SNA Retarget	SNA Withdrawal	ECA	TSNA	TSNA Withdrawal	TECA
070	Not Used								
071	Not Used								
072	Not Used								
073	Excluded product	Complex Service cannot be ported							
074	Not Used								
075	Not Used								
076	Not Used								
077	Batch Number NOT unique	Batch Number is being used for another active Port for the same Gaining C/CSP							

The policy objective of the greatest practicable use of industry self-regulation without imposing undue financial and administrative burdens on industry is central to the regulatory scheme of the *Telecommunications Act 1997*.

ACIF was established to implement the policy of industry self-regulation. It is a company limited by guarantee and is a not-for-profit membership-based organisation. Its membership comprises carriers/carriage service providers, business and residential consumer groups, industry associations and individual companies.

ACIF's mission is to develop collaborative industry outcomes that foster the effective and safe operation of competitive networks, the provision of innovative services and the protection of consumer interests. In the development of Industry Codes and Technical Standards as part of its mission, ACIF's processes are based upon its principles of openness, transparency, consensus, representation and consultation. Procedures have been designed to ensure that all sectors of Australian society are reasonably able to influence the development of Standards and Codes. Representative participation in the work of developing a Code or Standard is encouraged from relevant and interested parties. All draft Codes and Standards are also released for public comment prior to publication to ensure outputs reflect the needs and concerns of all stakeholders.



**Published by:
COMMUNICATIONS
ALLIANCE LTD**

**Level 9
32 Walker Street
North Sydney
NSW 2060 Australia**

**Correspondence
PO Box 444
Milsons Point
NSW 1565**

**T 61 2 9959 9111
F 61 2 9954 6136
TTY 61 2 9923 1911
E info@commsalliance.com.au
www.commsalliance.com.au
ABN 56 078 026 507**

Care should be taken to ensure the material used is from the current version of the Standard or Industry Code and that it is updated whenever the Standard or Code is amended or revised. The number and date of the Standard or Code should therefore be clearly identified. If in doubt please contact Communications Alliance