

COMMUNICATIONS
ALLIANCE LTD



INDUSTRY GUIDELINE
G602.1:2009
LOCAL NUMBER PORTABILITY
IT SPECIFICATIONS AND OPERATIONS MANUAL
PART 1 – GENERAL, GIVE BACK AND PORTED
LOCAL NUMBER REGISTER PROCESSING

G602.1:2009 Local Number Portability IT Specifications and Operations Manual Part 1 – General, Give Back and Ported Local Number Register Processing Industry Guideline

First published as ACIF G602.1:2003

Second edition as ACIF G602.1:2005

Third edition as ACIF G602.1:2006

Fourth edition as ACIF G602.1:2007

Fifth edition as ACIF G602.1:2008

Sixth edition as G602.1:2009

Communications Alliance Ltd was formed in 2006 to provide a unified voice for the Australian communications industry and to lead it into the next generation of converging networks, technologies and services.

Disclaimers

1. Notwithstanding anything contained in this Industry Guideline:
 - (a) Communications Alliance disclaims responsibility (including where Communications Alliance or any of its officers, employees, agents or contractors has been negligent) for any direct or indirect loss, damage, claim, or liability any person may incur as a result of any:
 - (i) reliance on or compliance with this Industry Guideline;
 - (ii) inaccuracy or inappropriateness of this Industry Guideline; or
 - (iii) inconsistency of this Industry Guideline with any law; and
 - (b) Communications Alliance disclaims responsibility (including where Communications Alliance or any of its officers, employees, agents or contractors has been negligent) for ensuring compliance by any person with this Industry Guideline.
2. The above disclaimers will not apply to the extent they are inconsistent with any relevant legislation.

Copyright

© Communications Alliance Limited 2009

This document is copyright and must not be used except as permitted below or under the Copyright Act 1968. You may reproduce and publish this document in whole or in part for your or your organisation's own personal or internal compliance, educational or non-commercial purposes. You must not alter or amend this document in any way. You must not reproduce or publish this document for commercial gain without the prior written consent of Communications Alliance.

Organisations wishing to reproduce or publish this document for commercial gain (i.e. for distribution to subscribers to an information service) may apply to subscribe to the Communications Alliance Publications Subscription Service by contacting the Communications Alliance Business Manager at info@commsalliance.com.au. If you publish any part of this document for any purpose, you must also publish this copyright notice as part of that publication.

PARTICIPANTS

The Working Committee responsible for the revisions made to this Guideline consisted of the following organisations and their representatives:

Organisation	Membership	Representative
AAPT	Voting	Brian Chapman
ACMA	Non-voting	Gerry O'Reilly
ACMA	Non-voting	Greg Neylan
ACCC	Non-voting	Grant Young
Hutchison Telecoms	Voting	Brian Currie
Hutchison Telecoms	Non-voting	Alexander R Osborne
Verizon Business	Voting	Sean Barkley
Optus	Voting	Chris Tan
Paradigm.One	Voting	Dev Gupta
PowerTel	Voting	Geoff Brann
Telstra	Voting	Terry Dyer
TransAct	Non-voting	Wayne Bouffler

This Working Committee was chaired by Alexander R Osborne. James Duck of ACIF provided project management support.

2009 update: The Operations Reference Panel endorsed the change in clause 6.2 to include WA Daylight Savings Time.

TABLE OF CONTENTS

1	INTRODUCTION	4
1.1	Customer Authorisation	4
1.2	Porting Processes	4
1.3	Retarget and Withdrawal of Ports	5
1.4	Reversal or Emergency Return	5
1.5	Give Back and Quarantining of Telephone Numbers	5
1.6	Code Administration and Compliance and Complaint Handling	5
1.7	Third Party Porting	5
1.8	Ported Local Number Registers and Call Routing	5
1.9	Bilateral Agreements	5
1.10	Background	6
2	SCOPE AND OBJECTIVES	7
2.1	Scope	7
2.2	Objectives	7
3	ACRONYMS and DEFINITIONS	8
3.1	Acronyms	8
3.2	Definitions	9
4	REFERENCES	19
5	GIVEN	20
6	OPERATIONAL TIME AND SYSTEM AVAILABILITY	22
7	PORTING PROCESS	27
8	FILE DETAILS	28
8.1	Unique Reference Number	28
8.2	Reject	28
8.3	PNO File	28
8.4	Hot Batch File	28
8.5	Header	29
8.6	File Trailer	30
8.7	File Miscellaneous	30

9	TECHNICAL NETWORK ARCHITECTURE	31
9.1	Core Network Components	31
9.2	Network Structure	32
10	OPERATIONAL PROCESSES	33
10.1	Late Receipt of Notifications – PNO Process	33
10.2	Late Receipt of Notifications – FCN Process	33
10.3	Gaining C/CSP ECA Escalations	33
10.4	Delay in Provision of PNO or FCN Files	34
10.5	Porting Delays and Unplanned Outages	34
10.6	Manual Final Cutovers	34
10.7	Invalid Transactions (Not Expected)	34
10.8	Disputed Rejects	34
10.9	Batch Numbering	35
10.10	Batch Reference Number (BRN)	35
10.11	BRN Operational Requirements	35
10.12	Group Batch Reference Number (GBRN)	36
11	CUSTOMER COMPLAINTS MANAGEMENT	37
12	EMERGENCY PROCESSING	38
13	GIVEBACK	39
13.1	Giveback - Context Diagram	39
13.2	Giveback - Process Flow Diagrams	40
13.3	Giveback – Process Events and Validations	41
13.4	Giveback – Porting Timeframes	42
13.5	Giveback – Record Description	43
13.6	Giveback Confirmation	43
13.7	Giveback Rejection	43
14	GIVEBACK – RESPONSE CODES	44
15	PORTED LOCAL NUMBER REGISTER	48
15.1	Ported Local Number Register Purpose	48
15.2	PLNR Site	48
15.3	PLNR File Type	48
15.4	Frequency of Update	48
15.5	PLNR File Naming Convention	48

15.6	PLNR Action Indicators	49
15.7	PLNR Access	49
15.8	Accuracy of Ported Local Number Registers	49
15.9	Ported Local Number Register Population Rules	50
15.10	Ported Local Number Register – Record Description	63
<hr/>		
16	RESPONSE CODE REFERENCE TABLE	64
17	DATA DICTIONARY	67
18	BATCH VALIDATION EXAMPLES	71
<hr/>		
18.1	Service example	71
18.2	Scenario 1	71
18.3	Scenario 2	72
18.4	Scenario 3	73
18.5	Scenario 4	73
18.6	Scenario 5	74

1 INTRODUCTION

LNP sets out procedures to enable a Customer to retain their Telephone Number when transferring from one C/CSP to another, even though the relevant number range will still be allocated to the Donor C/CSP.

A C/CSP must provide LNP in accordance with the requirements set out in the ACIF C540:2007 *Local Number Portability* Industry Code (Code) and any relevant legislation or subordinate legislative instruments as issued from time to time by ACMA or the ACCC.

1.1 Customer Authorisation

Porting can only be authorised by the Customer (or a person authorised in writing by the Customer) using a CA (Customer Authorisation) which includes, but is not limited to, paper based, electronic, Internet pages or voice authorisations recorded on audio media). In this context it is important to note that the Customer is the person to whom a Telephone Number is issued by a C/CSP or who has the right to Port that Telephone Number. This may not necessarily be the person who has a direct contractual relationship with the Losing C/CSP (e.g. in a reseller scenario).

1.2 Porting Processes

Processes and procedures are described in the Code and include the Porting of Telephone Numbers associated with both simple services (i.e. single line PSTN services) and complex services associated with Portable Telephone Numbers. For the purposes of the Code there are four processes:

- (a) Cat. A (a process using an automated method within a standard timeframe typically used to Port Telephone Numbers associated with Simple Telephone Services);
- (b) Cat. B (a process using a semi-automated method but with varying Lead Time depending on the particular kind of service); and
- (c) Cat. C (a process which requires project management typically used to Port complex services).

The classification of complex services into Cat. B or Cat. C will be a matter to be dealt with in Bilateral Agreements between C/CSPs as well as on a case-by-case basis depending on specific Customer requirements. This classification process will depend on a variety of factors such as:

- (a) the switch technology used by each C/CSP; the nature of and varying delivery methods for particular kinds of complex service (e.g. indial, hunt group, VPN);
- (b) the size of the customer installation; and
- (c) the need to coordinate the Porting process with other Customer requirements.

- (d) Cat. D (a process using an automated method within a standard timeframe for services usually Ported using the Cat. A process and which are on ULLS Call Diversion).

1.3 Retarget and Withdrawal of Ports

A Port can be Retargeted up to two times. Where the need for further Retargeting is required the original Port process must be withdrawn, or allowed to expire, and a fresh Port process initiated.

1.4 Reversal or Emergency Return

A Reversal or Emergency Return may be initiated in the event that problems are encountered after Porting has been commenced.

The need for a Reversal or Emergency Return may arise for a variety of reasons. For example, fault conditions in the Gaining C/CSP's network or faults with the call redirection arrangements implemented in the Donor C/CSP.

1.5 Give Back and Quarantining of Telephone Numbers

Upon disconnection of a service the Telephone Number will be Given Back to the Donor C/CSP and placed into Quarantine.

1.6 Code Administration and Compliance and Complaint Handling

The Code and this Guideline identify the requirements for validation, confirmation or rejection of transactions. Reject reasons are clearly defined and are intended to maintain the integrity of the process e.g. ensure the correct Telephone Number is Ported. These transaction validation processes are not intended to in any way restrict the ability to provide LNP.

1.7 Third Party Porting

Third Party Porting is where the Donor C/CSP is neither the Losing C/CSP or the Gaining C/CSP.

Third Party Porting requires bilateral agreements to be in place between each of the parties involved.

1.8 Ported Local Number Registers and Call Routing

Information to facilitate Call Routing is provided by the Donor C/CSP who is required to notify C/CSPs, via a Ported Local Number Register, that a Port is pending, completed or did not proceed. This relates to all Ports, including Third Party Ports. All participants must use the Ported Local Number Registers to determine the correct Call Routing.

1.9 Bilateral Agreements

Although the terms and conditions on which Local Number Portability is to be provided are defined in the Code it is anticipated that these terms

and conditions will be supplemented by bilateral agreements that will normally cover matters such as:

- (a) commercial arrangements;
- (b) detailed operational arrangements; and
- (c) some C/CSP specific and service specific matters which by their nature are unable or unsuitable to be dealt with in the Code.

The Code sets minimum acceptable practices (including Standard Hours of Operation, activation targets and timeframes) which do not limit industry's ability to improve on the minimum level. The Code does not constrain two or more individual industry participants agreeing to different arrangements provided that those arrangements meet the minimum level defined in the Code and do not impact on the ability of other industry participants to inter work with parties to those arrangements in accordance with minimum acceptable practices. Arrangements to deal with Ports outside the Standard Hours of Operation in the Code would be a typical example of a matter to be agreed between C/CSPs outside of the scope of the Code.

1.10 Background

The first implementation of LNP was limited to the Porting of Telephone Numbers associated with simple services. Portability of Telephone Numbers was initially between the only two C/CSPs allocated local Telephone Numbers in the market place at the time. The initial scope of LNP was restricted, to ensure delivery in the required time frames.

Porting of Telephone Numbers associated with both Simple and Complex services subsequently followed, including Porting between additional C/CSPs and Third Party Porting (i.e. where the Donor is involved in a Port between two other parties). This Guideline supports a revised Code for LNP that provides for Porting involving a ULLS.

C/CSPs have decided to implement a variety of technical solutions to meet their obligations to provide LNP. These technical solutions include 'facility re-direct' and intelligent network based solutions. Any technical solution for LNP must be complemented by separate operational procedures and commercial arrangements.

There is an industry agreed ACIF Local Number Portability Network Plan which outlines the network trunking arrangements that Carriers may utilise in order to route calls to Ported Telephone Numbers. The ACIF Local Number Portability Network Plan gives specific examples and applies the Ported Telephone Number indicators contained within the interconnect dial plan associated with the interconnect signalling specification.

It should be noted that LNP refers to the Porting of Telephone Number(s) associated with the provision of a Local Service. Hence the performance characteristics and enhanced features offered by a Gaining C/CSP's Local Service may differ from those which were provided by the Losing C/CSP.

2 SCOPE AND OBJECTIVES

2.1 Scope

The scope of this Guideline is to provide the IT and operational requirements between C/CSPs in the implementation of LNP.

2.2 Objectives

To meet the Code requirements, this Guideline details the IT and operational procedures between C/CSPs for LNP as follows:

- (a) Context Diagrams;
- (b) Event Tree Diagrams;
- (c) Lifetime of a Port;
- (d) Process Flow Diagrams;
- (e) Process Events and Validations;
- (f) Third Party Port Activity;
- (g) Porting Timeframes; and
- (h) Record Descriptions.

The procedures in this document apply to all C/CSPs and their staff involved in activities pertaining to LNP.

In the event of any inconsistency between this Guideline and the Code, the Code will prevail to the extent of the inconsistency. If there is an inconsistency between the Code and the Numbering Plan then the Numbering Plan will prevail.

3 ACRONYMS AND DEFINITIONS

Please note that section references within these definitions apply to the ACIF C540:2007 *Local Number Portability* Industry Code, and not this Guideline.

3.1 Acronyms

For the purposes of the Guideline, the following acronyms apply:

ACIF	Australian Communications Industry Forum Limited
ACMA	Australian Communications and Media Authority
AP	Access Provider
AS	Access Seeker
ASD	Access Service Deliverer
CA	Customer Authorisation
Cat. A Process	Category A Process
Cat. B Process	Category B Process
Cat. C Process	Category C Process
Cat. D Process	Category D Process
CCA	Complex Cutover Advice
C/CSP	Carrier and/or a Carriage Service Provider
CNA	Complex Notification Advice
ECA	Electronic Cutover Advice
OASD	Originating Access Service Deliverer
LNP	Local Number Portability
PABX	Public Automatic Branch Exchange
PNO	Porting Notification Order
POI	Point of Interconnection
PSD	Prime Service Deliverer
PSS	Portability Service Supplier
SMBR	Switchless Multibasket Billing Redirection
SNA	Simple Notification Advice
SZU	Standard Zone Unit
TASD	Terminating Access Service Deliverer
TCCA	Transfer Complex Cutover Advice
TCNA	Transfer Complex Notification Advice
TECA	Transfer Electronic Cutover Advice
TrSD	Transit Service Deliverer

TSNA	Transfer Simple Notification Advice
ULLS	Unconditioned Local Loop Service

3.2 Definitions

For the purpose of the Guideline, the following definitions apply:

Access Line

means the line connecting a Customer's premises to a Local Exchange.

Act

means the *Telecommunications Act 1997*.

Access Product Package

means the Product Package available under SMBR containing all access related non-usage charges including rental for line access for a particular Service.

Access Provider

means a Carrier or Carriage Service Provider who supplies declared services to itself or other persons under Part XIC of the *Trade Practices Act 1974* (Cth).

Access Seeker

has the same meaning as in the *Trade Practices Act 1974* (Cth).

Access Service Deliverer

means the Carrier to whose network an access line is directly connected.

Account Number(s)

means a billing identification reference to which a service or services are associated and allocated by the ASD in its internal systems.

Bilateral Agreement

means any agreement between two parties.

Business Day

means any day from Monday to Friday (inclusive) other than a National Public Holiday or as otherwise agreed in Bilateral Agreements.

Carriage Service

has the same meaning as in the *Act*.

Carriage Service Provider

has the meaning given by section 87 of the *Act*.

Carrier

has the meaning given by section 7 of the *Act*.

Category A Process

means the default process to Port a Telephone Number which is, prior to Porting associated with:

- (a) a Simple Telephone Service; or
- (b) a non-Simple Telephone Service which the Losing C/CSP has declared can be ready for Porting using an automated process within two Business Days of receipt of an SNA.

Category B Process

means the process to Port Telephone Numbers associated with Complex Telephone Services that the Losing C/CSP has declared can be ready for Porting in a specified Lead Time.

Category C Process

means the process to Port Telephone Numbers that require project management. This is the default process for Telephone Numbers associated with Complex Telephone Services.

Category D Process

means the process to Port a Simple Telephone Number in conjunction with an unconditioned local loop request on an existing service where the Telephone Number must have ULLS Call Diversion active.

Commencement Time

means the Local Time at which work required to Port a Telephone Number using the Cat. B Process or a Cat. C Process is to commence in the Losing C/CSP's network.

Completion Advice

means an advice sent via the Final Cutover Notification Interface which enables the Losing C/CSP, or where applicable the Donor C/CSP, to advise the Gaining C/CSP that the LNP facility has been implemented.

Complex Cutover Advice

means an advice contained within a Porting Notification Order from the Gaining C/CSP to the Losing C/CSP which provides the cutover details for each batch using the Cat. B Process or Cat. C Process.

Complex Notification Advice

means an advice contained within a Porting Notification Order from the Gaining C/CSP to the Losing C/CSP which, provides the initial Porting details for each Telephone Number to be Ported using the Cat. B Process or Cat. C Process.

Complex Telephone Service

means a Local Service which is not a Simple Telephone Service.

Confirmation Advice

means an advice from the Losing C/CSP, or where applicable the Donor C/CSP, to the Gaining C/CSP which confirms that an SNA, CNA, CCA, Retarget, Give Back, Withdrawal, ECA, TSNA, TCNA, TCCA or TECA has been successfully validated by the Losing C/CSP or Donor C/CSP.

Customer

means a person to whom a Telephone Number is Issued.

Customer Authorisation

means an authorisation by the Customer or their agent to Port Telephone Numbers, containing the minimum mandatory requirements specified in Clause 7.1.4.

Cutover Date

means the date on which a Porting cutover is to be actioned as specified in the relevant ECA, CCA, TCCA, or TECA.

Cutover Time

means the Local Time at which a Porting cutover is to be actioned as specified in the ECA, CCA, TCCA or TECA.

Cutover Timeslot

means the period in which a Porting cutover is to be actioned for a Cat. B Process. The allowable periods are 0800, for 08:00am to 12:00 noon and 1300, for 01:00pm to 05:00pm (in each case given as Local Time).

Disconnection

means a service associated with a Telephone Number which has been cancelled by a C/CSP or Customer in accordance with the terms of the relevant agreement between them. Disconnected has the same meaning.

Donor C/CSP

means the C/CSP to which a Telephone Number has been allocated or transferred under the Numbering Plan.

Donor Transit Routing

means the provision of transit routing by a Donor C/CSP, where it:

- (a) receives a call from an Originating ASD without an indication of the correct terminating ASD;
- (b) determines that the Telephone Number has been Ported;
- (c) determines the terminating ASD for the call; and
- (d) delivers the call to a POI with the terminating ASD.

Electronic Cutover Advice

means an advice sent via the Final Cutover Notification Interface from the Gaining C/CSP to the Losing C/CSP to action a Porting Request in an SNA.

Emergency Retarget

means the change of a Cutover Date and Commencement Time on the day of the proposed Cutover as per Clauses 7.4.63 to 7.4.71.

Emergency Retarget Authorisation

means the authorised agreement between the Gaining C/CSP's project manager and the Losing C/CSP's project manager to implement an Emergency Retarget if required.

Emergency Return

means the re-establishment of a service which can be in the form of either the Customer's original service, or if that it is not possible, an alternative service. Emergency Return only applies to complex Ports.

Emergency Return Authorisation

means the prior agreement authorised by the Customer and agreed between the Gaining C/CSP's project manager and the Losing C/CSP's project manager to implement an Emergency Return if required.

Emergency Return Request Period

means the period of time to restore service to Telephone Numbers associated with Ports using the Cat. B Process or Cat. C Process in accordance with Clause 7.4.75.

Expiry Notification

means a notification provided by the Losing or Donor C/CSP to the Gaining C/CSP when a pending Porting Notification Advice expires.

Fault Centre

means the central group within the C/CSP which handles fault rectification for LNP processes.

Final Cutover Notification Interface

means the electronic interface which enables C/CSPs to send Porting transactions to each other in a minimum of five minutes. The Porting transactions which can be sent via the Final Cutover Notification Interface, include but are not limited to:

- (a) ECAs;
- (b) TECAs;
- (c) Confirmation Advices;
- (d) Completion Advices; and
- (e) Reject Advices.

Gaining C/CSP

means the C/CSP to which a Telephone Number has been or is to be Ported.

Give Back

means the return of a Ported Telephone Number from a Gaining C/CSP to the Donor C/CSP in accordance with Clauses 9.1.1 to 9.1.3. Given Back has a corresponding meaning.

Give Back Notification

means an advice from the Gaining C/CSP to the Donor C/CSP contained within a Porting Notification Order which notifies of a Give Back.

Implementation Schedule

means an agreement between the Gaining C/CSP's project manager and the Losing C/CSP's project manager which includes the relevant activities for the Port specified in Clause 7.4.61 of the Code.

Issued

means the status of a Telephone Number from the time that a C/CSP or its delegate and the Customer agree to the provision of a specific Telephone Number for the Customer's use in association with a Standard Telephone Service. Issue has a corresponding meaning.

Lead Time

means the period determined by the Losing C/CSP and advised to the Gaining C/CSP to prepare a Telephone Number for Porting using the Cat. B Process.

Local Exchange

means the exchange owned or operated by a C/CSP to which a Telephone Number is directly connected.

Local Number Portability

means the Porting of Telephone Number(s) associated with the provision of a Local Service, from a Losing C/CSP network to a Gaining C/CSP network (but not any service or features associated with the Telephone Number(s)).

Local Service

has the same meaning as in the *Telecommunications Numbering Plan 1997*.

Local Time

means the time zone applicable to the geographic area to which the Telephone Number being Ported is assigned.

Losing C/CSP

means the C/CSP from which a Telephone Number has been or is to be Ported.

Modified Cat. A Process

means the process to Port Telephone Numbers associated with a Simple Telephone Service which cannot be Ported using the end-to-end Category A Process. The Modified Cat. A Process uses the Cat. A Process transactions.

National Public Holiday

means a day on which a public holiday is declared by all States and Territories, or any other day as agreed in Bilateral Agreements.

Network Provider

means an OASD, PSD, PSS or a TrSD.

Numbering Plan

means the *Telecommunications Numbering Plan 1997*.

Originating Access Service Deliverer

means a C/CSP that provides outgoing services to Customers that connect to other telecommunications services.

Pending Disconnection

means the service associated with the Telephone Number has an active Customer or C/CSP initiated disconnection order in place.

Point Of Interconnection

means a physical point of connection between a network operated by the AP and another network operated by the AS, located at or associated with a Customer Access Module and located on the end user side of a Customer Access Module.

Port

means the movement of Telephone Numbers between C/CSPs using LNP processes. The words Porting and Ported have corresponding meanings.

Portability Service Supplier

means a Carrier or CSP or their agent or a contractor who provides supporting services to Carriers and/or Carriage Service Providers in the provision and operation of LNP. For example, Port administration services, Ported Telephone Number reference databases and network services for call routing.

Ported Local Number Register

means a web site that contains a file with a list of Telephone Numbers that have been Ported away from the Donor, or have just returned.

Ported Telephone Number

means a Telephone Number which has been successfully Ported to another C/CSP who is not the Donor C/CSP.

Porting Inquiry Period

means the period commencing:

- (a) two hours after the transmission/receipt of an ECA or TECA for a Telephone Number being Ported using the Cat. A Process; or
- (b) four hours after the start of the Cutover Timeslot for a Telephone Number being Ported using the Cat. B Process, or
- (c) two hours after the transmission/receipt of an ECA, and ending at the delivery of the Completion Advice for a Telephone Number being Ported using the Cat. D Process.

Porting Notification Advice

means a Simple Notification Advice (SNA), a Complex Notification Advice (CNA), a Transfer Simple Notification Advice (TSNA) or a Transfer Complex Notification Advice (TCNA).

Porting Notification Order

means an electronic transfer of information on Business Days between a Gaining and Losing C/CSP or Donor C/CSP and for the avoidance of doubt this may include but is not limited to:

- (a) Complex Cutover Advices;
- (b) Complex Notification Advices;
- (c) Confirmation Advices;

- (d) Expiry Notifications;
- (e) Give Back Notifications;
- (f) Port Pending Advices;
- (g) Port Pending Cancellations;
- (h) Receipt Advices;
- (i) Reject Advices;
- (j) Retargets;
- (k) Simple Notification Advices;
- (l) Transfer Simple Notification Advices;
- (m) Transfer Complex Notification Advices;
- (n) Transfer Complex Cutover Advices; and
- (o) Withdrawals.

Porting Request

means a request for a Port contained in a CA. Port Request has the corresponding meaning.

Pre-selection

is outlined in Part 17 of the Act.

Prime Service Deliverer

means in respect of a Standard Telephone Service, the service deliverer selected by the Customer for the carriage of all preselectable calls originating from the Standard Telephone Service.

Provisioning Centre (of a C/CSP)

means the central group within the C/CSP which handles the LNP processes.

Quarantine

means the status of a Telephone Number which has been Ported and Given Back to the Donor C/CSP and which is held by the Donor C/CSP and is not Issued to any customer except in accordance with Clause 9.1.12.

Receipt Advice

means an advice provided by the Losing C/CSP to the Gaining C/CSP to confirm that a CNA, CCA, CCA Retarget, TCNA or TCCA has been received.

Receipt Time

means the receiving C/CSP's system date and time stamp for a file.

Reject Advice

means an advice from the Losing C/CSP or where applicable the Donor C/CSP to the Gaining C/CSP, forwarded through a Porting Notification Order or Final Cutover Notification Interface (as applicable), which specifies that a Porting Request in a Porting Notification Advice, Complex Cutover Advice, Withdrawal, Retarget, Give Back, TCCA, TECA

or an ECA has been rejected by the Losing C/CSP, or where applicable the Donor C/CSP. For those transactions sent via the Final Cutover Notification Interface, Reject Advices are normally sent during the Standard Hours of Operation, however for those Porting Requests received towards the end of Standard Hours of Operation, Reject Advices may be sent outside Standard Hours of Operation.

Resale

means the billing of the End User by a CSP for the use of telecommunication services where the Service Provider is not the ASD of the service.

Retarget

means a change to an SNA, CNA (Cat. B only), CCA or TCCA which has been previously advised by the Gaining C/CSP to the Losing C/CSP or the Donor C/CSP.

Reversal

means the reinstatement of a Customer's service with the Losing C/CSP during the Reversal Period in accordance with Clauses 7.2.50 to 7.2.52 for Telephone Numbers Ported using the Cat. A Process or Clauses 7.5.35 to 7.5.38 for Telephone Numbers Ported using the Cat. D Process. Reversals are not permitted for the Cat. B Process and Cat. C Process. Reverse has a corresponding meaning.

Reversal Period

means the period commencing on the completion of cutover and ending on the earlier of:

- (a) four hours after the completion of the cutover; and
- (b) the end of the Standard Hours of Operation; or
- (c) as otherwise agreed between the appropriate parties.

Service Information

means the account number(s) for Telephone Number(s), unless otherwise agreed in Bilateral Agreements.

Simple Notification Advice

means an advice contained within a Porting Notification Order which provides the details required for a Telephone Number to be Ported using the Cat. A Process, Modified Cat. A Process or Cat. D Process.

Simple Telephone Service

means a Local Service which comprises a:

- (a) Standard Telephone Service; and
- (b) Telephone Number,

where there exists a one to one relationship between the Telephone Number and the relevant access line to the Standard Telephone Service.

Simple Telephone Service Threshold

means the number of Telephone Numbers that can be Ported using the Modified Cat. A Process before the Losing C/CSP must implement changes to its procedures and systems.

Standard Hours of Operation

means 8 a.m. to 5 p.m. (Standard Time) on Business Days.

Standard Porting

means the Porting process where the Port is between two C/CSPs, one of which is the Donor C/CSP.

Standard Telephone Service

has the same meaning as in the *Telecommunications (Consumer Protection & Services Standards) Act 1999*.

Standard Time

means:

- (a) Eastern Standard Time (GMT plus 10 hours); or
- (b) Eastern Daylight Saving Time (GMT plus 11 hours) when in effect in New South Wales.

Standard Zone Unit

has the same meaning as in the Numbering Plan.

Switchless Multibasket Billing Redirection

means the redirection of billing from the ASD to the CSP where billing information is provided to the Service Provider.

Telephone Number

means a geographic number that is declared Portable in the Numbering Plan relating to LNP.

Terminating Access Service Deliverer

means a C/CSP that provides access for connection by a Customer to incoming telecommunication services.

Third Party Porting

means Ports where the Donor C/CSP is not the Gaining C/CSP or the Losing C/CSP.

Transfer

means the activity by the Donor C/CSP to change the redirection of calls from the Losing C/CSP to the Gaining C/CSP, where the Donor C/CSP is neither the Gaining C/CSP or the Losing C/CSP. Transferred has a corresponding meaning.

Transfer Complex Cutover Advice

means an advice contained within a Porting Notification Order from the Gaining C/CSP to the Donor C/CSP.

Transfer Complex Notification Advice

means an advice contained within a Porting Notification Order from the Gaining C/CSP to the Donor C/CSP which provides the details as required for each Telephone Number to be Transferred using the Cat. B Process or Cat. C Process.

Transfer Electronic Cutover Advice

means an advice sent via the Final Cutover Notification Interface for a Third Party Port. This enables the Gaining C/CSP to advise the Donor C/CSP to implement a Transfer. A TECA can only be used for a Transfer using the Category A Process.

Transfer Reversal

means the activities by the Donor C/CSP and Gaining C/CSP in a Third Party Port to restore the call routing back to the Losing C/CSP's network. Transfer Reversals are implemented in accordance with Clauses 8.2.28 to 8.2.30.

Transfer Simple Notification Advice

means an advice contained within a Porting Notification Order from the Gaining C/CSP to the Donor C/CSP which provides the details as required for each Telephone Number to be Transferred using the Cat. A Process.

Transit Service Deliverer

means a C/CSP that connects with and passes call traffic from the OASD to a TrSD or the TASD.

ULLS Call Diversion

means an exchange based facility that enables calls to a Telephone Number to be diverted to another Telephone Number (for example, a geographic or mobile Telephone Number) for a period of up to 30 calendar days.

Unconditioned Local Loop Service

means the use of unconditioned communications wire between the boundary of a telecommunications network at an end user's premises and a point on a telecommunications network that is a potential Point of Interconnection located at or associated with a Customer Access Module and located on the end user side of the Customer Access Module. The term ULLS can be taken as being both singular and plural.

Wholesale Account Number

means the Account Number between the Losing C/CSP and another CSP who is rebilling the end user Customer.

Withdrawal

means the cancellation of a Porting Request by the Gaining C/CSP to the Donor C/CSP or Losing C/CSP in accordance with the Code. Withdraw has a corresponding meaning.

4 REFERENCES

Publication	Title
Industry Codes	
ACIF C540:2007	Local Number Portability
ACIF C513:2004	Customer and Network Fault Management
ACIF C515:2005	Pre-selection - Single Basket/Multi Service Deliverer
ACIF C566:2005	Rights of Use of Numbers
ACIF C569:2005	Unconditioned Local Loop Service - Ordering, Provisioning and Customer Transfer
Industry Guidelines	
ACIF G600:2005	Allocation of Eligible Part Identification Codes Industry Guideline
ACIF G514:2003	Code Administration and Compliance Scheme
ACIF G520:2005	Local Number Portability – Network Plan
ACIF G562:2000	Electronic Customer Authorisation
ACIF G567:2001	Switchless Multibasket Billing Redirection
ACIF G603:2004	Local Number Portability Test Strategy
ACIF G613:2004	Local Number Portability Test Plan
Industry Documents	
<i>Privacy Act 1988 (Cth)</i>	
<i>Telecommunications Act 1997 (Cth)</i>	
<i>Telecommunications (Consumer Protection & Services Standards) Act 1999 (Cth)</i>	
<i>Telecommunications Numbering Plan 1997 (Cth)</i>	
<i>Trade Practices Act 1974 (Cth)</i>	

5 GIVEN

- 5.1 Operational Business Days and related times are stipulated in the Code for LNP.
- 5.2 Extended operational Business Days and related times can be stipulated in the Bilateral Agreements between C/CSPs.
- 5.3 Validation rules for each process are not in any predefined order.
- 5.4 The Gaining C/CSP will arrange for connection of the service prior to the Final Cutover Notification for the Cat. A Process or the Cat. D Process and prior to the actual cutover for the Cat. B Process or the Cat. C Process.
- 5.5 For Third Party Porting, the Gaining C/CSP is responsible for initiating and managing separate transactions to both the Losing C/CSP and the Donor C/CSP.
- 5.6 A C/CSP must generate one PNO file per Business Day for each C/CSP with whom they have a Porting arrangement.
- 5.7 For Cat. A, Cat. D and Give Back transactions there is an optional reference number that can be utilised. Optional population means that it is not mandatory for the Gaining C/CSP to populate this field when sending their transactions. However if the reference number is present in the original notification then it must be present in the response.
- 5.8 Rejections that are not associated to a particular Response code will be aggregated to a general Response code e.g. an error in the date field of a record will return a Response code of "invalid record format" rather than a Response code of "invalid date".
- 5.9 The processing of Hot Batch transactions will only occur during the Standard Hours of Operation.
- 5.10 To ensure that the network infrastructure is operational and that end-to-end transmission failures are identified as soon as possible, C/CSPs must send a PNO file on every Business Day to all C/CSPs with whom they Port. If there are no request records, an empty PNO file must be sent. The empty PNO file must have a header, trailer and a zero record count. The following are examples of transmission failures:
 - (a) Firewalls not allowing access
 - (b) FTP userid and/or passwords have been disabled or changed
 - (c) Lease line failures
 - (d) All records in the PNO files will be processed in the order that they are received i.e. no sorting prior to processing.
- 5.11 Any rejection of a subsequent transaction after the confirmation of the SNA or CNA will not have any impact on the expiry date of the Port i.e. the rejection of a CCA Retarget Notification will not impact the current expiry date of the Port.
- 5.12 The file layouts include a Record Version number field for all record types. This field is not validated.

- 5.13 Once a CCA is confirmed, the Port will be completed unless further action is taken by the Gaining C/CSP, i.e. Emergency Retarget, Emergency Return, CCA Retarget or a CCA Withdrawal.
- 5.14 Where an Emergency Retarget or an Emergency Return has occurred, the Losing C/CSP must be able to accept a new CCA.
- 5.15 A CCA Retarget for the Cat. B Process extends the lifetime of the Port as well as rescheduling the Cutover Date and Commencement Time.
- 5.16 A CCA Retarget for the Cat. C Process only reschedules the Cutover Date and Commencement Time but does not extend the lifetime of the port.
- 5.17 A TCCA Retarget for the Cat. B Process and the Cat. C Process only reschedules the Cutover Date and Commencement Time but does not extend the lifetime of the Third Party Port.
- 5.18 For a Third Party Port, both the SNA and the TSNA must be confirmed before either an ECA or a TECA is sent.
- 5.19 The TECA confirmation must be received prior to the ECA being sent.
- 5.20 The Gaining C/CSP determines whether an ECA is sent after the receipt of either the TECA confirmation or the TSNA completion.
- 5.21 A Complex batch sent to the Losing C/CSP may contain Telephone Numbers for multiple Donor C/CSPs. The Gaining C/CSP must determine for each Telephone Number the Donor C/CSP and whether Third Party Porting is required.
- 5.22 Wholesale Account Number examples may include, but are not limited to:
 - (a) where the Telephone Number to be Ported is in a Commercial Churn Arrangement, the service account number used for validation by the Losing C/CSP is the commercial churn service provider's account number with the Losing C/CSP; or
 - (b) where the Telephone Number to be Ported is in a SMBR arrangement for the Access Product Package, the Wholesale Account Number used for validation by the Losing C/CSP is the SMBR service provider's account number with the Losing C/CSP.
- 5.23 If the Gaining C/CSP requests the Losing CSP's Wholesale Account Number(s) as the Customer's agent, the Gaining C/CSP may provide the Losing CSP with one excel spreadsheet per Business Day with the requested Telephone Numbers from that Losing CSP.
- 5.24 Any variations to this Guideline will be subject to Bilateral Agreements.

6 OPERATIONAL TIME AND SYSTEM AVAILABILITY

- 6.1 All time values in transactions are specified in Local Time (i.e. Sydney, Perth etc).
- 6.2 To support different time zones CCAs and TCCAs and their associated Retarget transactions include a time zone field. This time zone is specified as the time difference from GMT. The valid values are:
 - (a) 0800 for Perth/WA
 - (b) 0930 for Darwin/NT and Adelaide/SA
 - (c) 1000 for Brisbane/QLD, Sydney/NSW, Canberra/ACT, Melbourne/VIC and Hobart/TAS
 - (d) 0900 for Perth/WA during Daylight Saving
 - (e) 1030 for Adelaide/SA during Daylight Saving
 - (f) 1100 for Sydney/NSW, Canberra/ACT, Melbourne/VIC and Hobart/TAS during Daylight Saving.
- 6.3 It is the responsibility of the Gaining C/CSP to ensure the time zone GMT value is correct.
- 6.4 It is the responsibility of the Losing C/CSP and the Donor C/CSP to apply any necessary conversion due to time zone differences.
- 6.5 The agreed operational times are specified in Sydney Local Time i.e. Start of day processing for the daily file will be 7.00am Sydney Local Time.
- 6.6 The agreed operational window for Hot Batch notification and responses and Port completions is specified in Sydney Local Time.
- 6.7 Only those PNO files received before the start of the Business Day will be processed as having been received on that Business Day and will have a Receipt Date of that Business Day. PNO files received after the start of the Business Day will be processed as if they were received on the following Business Day and will have a Receipt Date of the next Business Day.
- 6.8 The receipt time for all files is the date/time stamp when the file is received by the C/CSP.
- 6.9 Clock synchronisation will be specified as part of the Bilateral Agreement between C/CSPs.
- 6.10 The Receipt Date of the PNO file will be known as Day 0 and is determined based on the receipt time of the PNO file. PNO files received before 7:00 am on a Business Day will have a Receipt Date of that Business day. PNO files received after 7:00 am on a Business Day will have a Receipt Date of the next Business day.
- 6.11 The Receipt Date is used as the basis for determining all date based time periods.
- 6.12 The Port Expiry will take effect at the end of Standard Hours of Operation on that Business Day.
- 6.13 The following tables identify the calculation of Business Days and calendar days.

Business Days

PNO Received	Mon	Tue	Wed	Thu	Fri	Sat	Sun	Mon	Tue
6:00 am Mon	Day 0	Day 1	Day 2	Day 3	Day 4			Day 5	Day 6
6:00 am Fri					Day 0			Day 1	Day 2
8:00 am Thu					Day 0			Day 1	Day 2
6:00 am Wed			Day 0	Day 1	P/Hol			P/Hol	Day 2

Calendar Days

PNO Received	Mon	Tue	Wed	Thu	Fri	Sat	Sun	Mon	Tue
6:00 am Mon	Day 0	Day 1	Day 2	Day 3	Day 4	Day 5	Day 6	Day 7	Day 8
6:00 am Fri					Day 0	Day 1	Day 2	Day 3	Day 4
8:00 am Thu					Day 0	Day 1	Day 2	Day 3	Day 4
6:00 am Wed			Day 0	Day 1	Day 2 P/Hol	Day 3	Day 4	Day 5 5P/Hol	Day 6

Cat. A

PNO Received	Mon	Tue	Wed		Mon	Tue	Wed
	30/6	1/7	2/7		28/7	29/7	30/7
At 6:45 am Mon	Day 0	Day 1	Day2	Day 3 to Day 27	Day 28	Day 29	Day 30
SNA	SNA received	SNA Confirmation received					
ECA			ECAs can be received during Standard Hours of Operation for this day	ECAs can be received during Standard Hours of Operation for these days	ECAs can be received during Standard Hours of Operation for these days	ECAs can be received during Standard Hours of Operation for this day	ECAs rejected
Retarget			Retargets can be received	Retargets can be received	Last day for a Retarget to be received	Retargets rejected	
Expiry	30 days to Expiry	29 days to Expiry	28 days to Expiry	27 to 3 days to Expiry	2 days to Expiry	Expiry at end of Standard Hours of Operation today	Expiry notification received

Cat. C

	At 6:45am Mon	Calendar Days	Business Days	CNA	CCA	CCA Retarget	Expiry
Mon	1/5	Day 0	Day 0	CNA received			120 days to Expiry
Tue	2/5	Day 1	Day 1	CNA Receipt advice received			119 days to Expiry
Wed	3/5	Day 2	Day 2				118 days to Expiry
Thu	4/5	Day 3	Day 3				117days to Expiry
Fri	5/5	Day 4	Day 4				116 days to Expiry
Sat	6/5	Day 5					115 days to Expiry
Sun	7/5	Day 6					114 days to Expiry

	At 6:45am Mon	Calendar Days	Business Days	CNA	CCA	CCA Retarget	Expiry
Mon	8/5	Day 7	Day 5	CNA Confirma tion received			113 days to Expiry
Mon	12/6	Day 42 Queen's Birthday	P/Hol				78 days to Expiry
Mon	14/8	Day 105	Day 74				15 days to Expiry
Tue	15/8	Day 106	Day 75				14 days to Expiry
Wed	16/8	Day 107	Day 76				13 days to Expiry
Thu	17/8	Day 108	Day 77				12 days to Expiry
Fri	18/8	Day 109	Day 78				11 days to Expiry
Sat	19/8	Day 110					10 days to Expiry
Sun	20/8	Day 111					9 days to Expiry
Mon	21/8	Day 112	Day 79		Last day for the receipt of a CCA (if Cutover Date is before Business Hours on 28/8)	Last day for the receipt of a CCA Retarget (if existing Cutover Date is before Business Hours on 28/8)	8 days to Expiry
Tue	22/8	Day 113	Day 80		Receive CCA Receipt advice	Receive CCA Retarget Receipt advice	7 days to Expiry
Wed	23/8	Day 114	Day 81				6 days to Expiry
Thu	24/8	Day 115	Day 82		Receive CCA Confirma tion/ Rejection	Receive CCA Retarget Confirma tion/ Rejection	5 days to Expiry
Fri	25/8	Day 116	Day 83				4 days to Expiry

	At 6:45am Mon	Calendar Days	Business Days	CNA	CCA	CCA Retarget	Expiry
Sat	26/8	Day 117					3 days to Expiry
Sun	27/8	Day 118					2 days to Expiry
Mon	28/8	Day 119	Day 84				Expiry at midnight today
Tue	29/8	Day 120	Day 85				Expiry notification received
Wed	30/8	Day 121	Day 86				

7 PORTING PROCESS

7.1 The following table identifies the allowable Porting Processes for Telephone Numbers.

In the table below:

Column 1 represents a Telephone Number associated with a Simple Telephone Service and can be Ported using the Cat. A Process or the Cat. B Process or the Cat. C Process (The Cat. A Process is the default process).

Column 2 represents a Telephone Number associated with a Complex Batch which does not require project management and can be Ported using the Cat. B Process or the Cat. C Process (The Cat. B Process is the default process).

Column 3 represents a Telephone Number associated with a Complex Batch which does require project management and can only be Ported using the Cat. C Process.

Column 4 represents a Telephone Number associated with a ULLS and can only be Ported using the Cat. D Process.

Scenario	Description	Porting Process			
		1	2	3	4
Donor as Losing C/CSP	A customer wishes to take their Telephone Number from their current C/CSP (Losing C/CSP) to another C/CSP (Gaining C/CSP)	Cat A Cat B Cat C	Cat B Cat C	Cat C	Cat D
Donor as Gaining C/CSP	A customer wishes to return to their original C/CSP (Gaining/Donor C/CSP) with their Telephone Number from their current C/CSP (Losing C/CSP)	Cat A Cat B Cat C	Cat B Cat C	Cat C	N/A
Third Party	A customer wishes to take their Telephone Number from their current C/CSP (Losing C/CSP) to another C/CSP (Gaining C/CSP) where neither party is the Donor C/CSP.	Cat A Cat B Cat C	Cat B Cat C	Cat C	N/A
Giveback	A C/CSP (Losing C/CSP) will give back a Telephone Number to the Donor C/CSP (Gaining C/CSP) without the customer i.e. the Telephone Number is no longer required on the Losing C/CSP's network.	Giveback	Giveback	Giveback	Giveback

8 FILE DETAILS

8.1 Unique Reference Number

Each PNO file must contain a unique sequential file reference number. PNO files with duplicated file reference numbers will be rejected at file level and not at Telephone Number level.

8.2 Reject

Records in a PNO file that are not in the required format will be rejected at the record level.

8.3 PNO File

Attribute Name	Format	Comment
Record Type	CHAR(1)	Value is D
C/CSP Creator	NUM(3)	The three digit numeric Identification Code as per ACIF Eligible Party Identification Code List as allocated under ACIF G600 ACIF Allocation of Eligible Party Identification Codes Industry Guideline.
C/CSP Receiver	NUM(3)	The three digit numeric Identification Code as per ACIF Eligible Party Identification Code List as allocated under ACIF G600 ACIF Allocation of Eligible Party Identification Codes Industry Guideline.
File Sequence Number	NUM(4)	Starts at an agreed number (e.g. 0001) and increments by 1 to 9999 when the numbering restarts at 0001. Files are processed in order.
File Creation Date	CCYYMMDD	Standard date field

8.4 Hot Batch File

Attribute Name	Format	Comment
Record Type	CHAR(1)	Value is H
C/CSP Creator	NUM(3)	The three digit numeric Identification Code as per ACIF Eligible Party Identification Code List as allocated under ACIF G600 ACIF Allocation of Eligible Party Identification Codes Industry Guideline.
C/CSP Receiver	NUM(3)	The three digit numeric Identification Code as per ACIF Eligible Party Identification Code List as allocated under ACIF G600 ACIF Allocation of Eligible Party Identification Codes Industry Guideline.
File Sequence Number	NUM(4)	Starts at an agreed number (e.g. 0001) and increments up to 9999 when the numbering restarts at 0001. Files are processed in order as they are

Attribute Name	Format	Comment
		received (i.e. can be out of sequence order).
File Creation Date	CCYYMMDD	Standard date field

8.5 Header

Attribute Name	Data Type	Value	Mandatory	Comment
Record Version	NUM(2)	01	Y	Value is "01"
Record Type	NUM(3)	001	Y	Value is "001"
Creation Date	DATE(8)		Y	Format CCYYMMDD
File Type	CHAR(1)	D or H	Y	Value is daily batch ('D') and hot batch ('H') file for files to the Gaining, Losing or Donor C/CSP's
C/CSP Creator	NUM(3)		Y	The three digit numeric Identification Code as per ACIF Eligible Party Identification Code List as allocated under ACIF G600 ACIF Allocation of Eligible Party Identification Codes Industry Guideline.
C/CSP Receiver	NUM(3)		Y	The three digit numeric Identification Code as per ACIF Eligible Party Identification Code List as allocated under ACIF G600 ACIF Allocation of Eligible Party Identification Codes Industry Guideline.
File Sequence Number	NUM(4)	Y	Y	Daily File (D): Starts at an agreed number e.g. 0001 and increments by 1 to 9999 when the numbering restarts at 0001. Files are processed in order. Hot Batch File (H): Is unique on the day the file is sent. Files are processed when received. For situations when there is a backlog of files, the files are processed based on file date/time.

8.6 File Trailer

Attribute Name	Data Type	Value	Mandatory	Description
Record Version	NUM(2)	01	Y	Value is "01"
Record Type	NUM(3)	999	Y	Value is "999"
Detail Record Count	NUM(7)		Y	Value is to equal the number of records of record type "002" to record type "998".

8.7 File Miscellaneous

PNO File records are a fixed length format of 250 characters.

Hot Batch files are a fixed length format of 60 characters.

Alphanumeric fields are left justified and space padded.

Numeric fields are right justified and zero padded.

All files use the ASCII character set.

Fixed length records will have a line feed at the end of each record.

9 TECHNICAL NETWORK ARCHITECTURE

The network architecture to be utilised is agreed bilaterally between C/CSPs.

9.1 Core Network Components

The following is a high level description of the core components required to be agreed to establish connectivity between the C/CSPs.

Req No	Network Components	Description (example only)
1	Data Transfer Network	Permanent Data line
2	Communication link to Data Transfer Network	Permanent Data link
3	Redundancy	If both C/CSP's agree, to ensure continuous service, a second link can be established for contingency purposes
4	Security	Security components to be agreed including <ul style="list-style-type: none">• Firewall's are utilised so as to ensure only the appropriate C/CSP's data files are accepted• Userid/ Password protection• Use of dedicated lines
5	Protocol	To be agreed e.g. TCP/IP Standard communication protocol
6	Data Transfer Method	To be agreed e.g. FTP (send)
7	Accounts	Account details to be agreed including : <ul style="list-style-type: none">• One Test account (HOST/FIREWALL)• One Production account (HOST/FIREWALL)• Both allow multiple logon sessions• Changes to passwords are a manual operational process between C/CSP's

9.2 Network Structure

The network architecture is based on dedicated lines between the C/CSPs involved in LNP. Redundancy may be built into the design so as to ensure that if a data link were to drop out then the other (which is a back up) would come on line to protect the C/CSP's daily business operations.

Each C/CSP must have a separate FTP account to undertake testing so as to separate test data files from production data files. The responsibility will be on the receiving C/CSP to ensure that the test FTP account is not the same as the production FTP account.

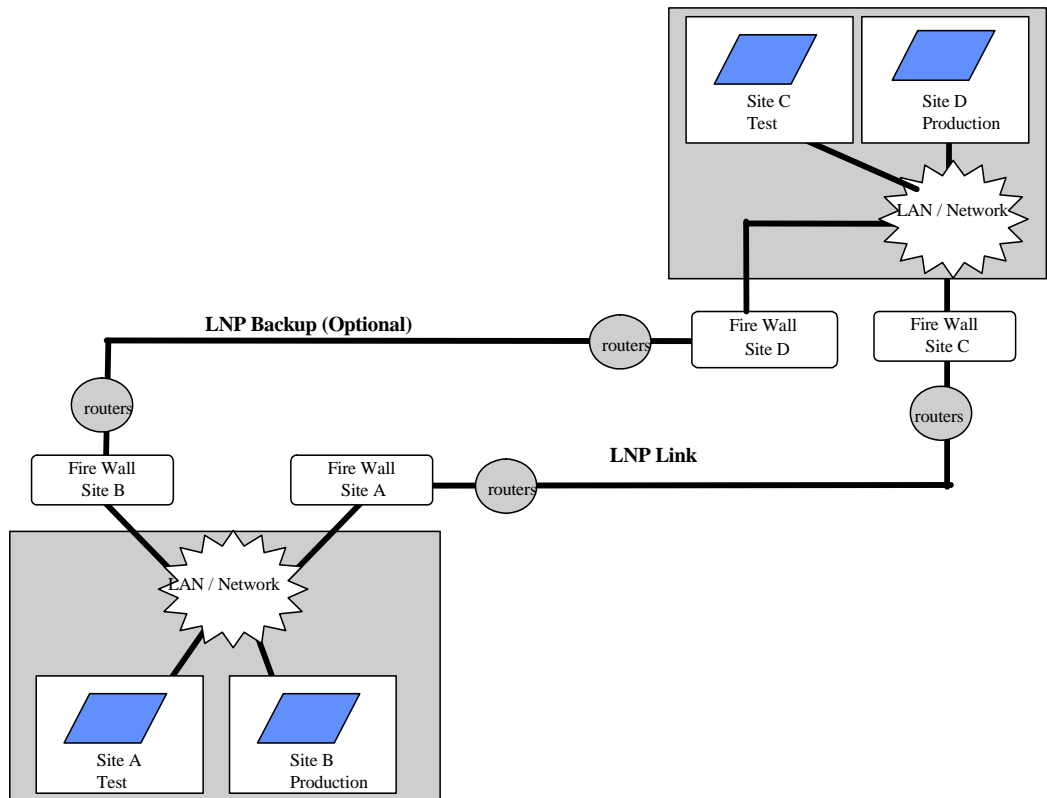

10 OPERATIONAL PROCESSES

File Transfer Disruption Process

10.1 Late Receipt of Notifications – PNO Process

- 10.1.1 In the instance where a response on any Port notification is not provided within the agreed time frames, the Gaining C/CSP must advise the Losing C/CSP as soon as possible after detection of the problem by facsimile, email or other method, as agreed. If a problem is detected by the Losing C/CSP or Gaining C/CSP that may impact on a Port, the party identifying the problem will notify the other party by facsimile or phone. The Losing C/CSP or Gaining C/CSP must respond to this facsimile or call within two hours after receipt, where possible.
- 10.1.2 The responding party's notification must detail the current status of the problem and whether each Porting notification is accepted, rejected or unprocessed. Response codes, if rejected, must be included in the response and advices will be forwarded by the PNO File.

10.2 Late Receipt of Notifications – FCN Process

- 10.2.1 In the instance where a response on any Cutover notification is not provided within the agreed time frames, the Gaining C/CSP must advise the Losing C/CSP as soon as possible after detection of the problem by phone. If a problem is detected by the Losing or Gaining C/CSP that may impact on a Cutover, the party identifying the problem will notify the other party by phone. The Losing or Gaining C/CSP must respond to this call within 30 minutes after receipt, where possible.
- 10.2.2 The responding party's notification must detail the current status of the problem and whether each Cutover notification is accepted, rejected or unprocessed. Reject codes, if appropriate, must be included in the response and advices must be forwarded by the Final Cutover Notification Interface.

10.3 Gaining C/CSP ECA Escalations

- 10.3.1 The Gaining C/CSP may forward escalations to the nominated Losing C/CSP's representative via phone, to be confirmed by facsimile or e-mail, whenever a Receipt Advice or Completion Advice has not been received within two hours of receipt of a valid ECA.
- 10.3.2 The escalation must include the file details, Telephone Number and associated account number. The Losing C/CSP shall advise the Gaining C/CSP's Provisioning Centre by telephone within 30 minutes (to be confirmed by facsimile or e-mail) the reason for the delay and the expected time of delivery of the Receipt Advice or Completion Advice.

10.4 Delay in Provision of PNO or FCN Files

In the instance where the PNO file or the FCN files are not received, each party agrees to notify the other party's nominated contact as soon as the problem has been identified

10.5 Porting Delays and Unplanned Outages

The nominated operations contact personnel must advise by phone and confirm in writing, where required, of these delays. The Losing C/CSP will also advise the Gaining C/CSP when these problems have been rectified. Both parties should endeavour to advise each other of problems within one hour of the problem being detected or rectified. The operational contacts will agree whether it is appropriate to switch to manual cutover processing.

10.6 Manual Final Cutovers

C/CSP's will agree on processes through bilateral arrangements to manage manual cutovers during periods when LNP systems or interfaces prevent standard Porting processes from being followed.

10.7 Invalid Transactions (Not Expected)

10.7.1 In the case that either the Gaining or Losing C/CSP receives a transaction which is not expected, (e.g. a confirmation is received where a notification hadn't been generated) that party will either:

- (a) provide a reject transaction (where it is appropriate to provide an electronic response); or
- (b) advise the party, from which they have received the transaction, by facsimile, that this event has occurred.

10.7.2 The notifying party will include all relevant details when raising this problem including Telephone Number, batch reference number (where applicable), date of receipt and an indication of whether it was received in a PNO File or via the Final Cutover Notification Interface.

10.7.3 The party to whom this problem is raised will investigate why this transaction was sent and respond by facsimile within one Business Day of the receipt of the inquiry.

10.8 Disputed Rejects

10.8.1 If a Customer disputes a reject with the Gaining C/CSP, the Gaining C/CSP's operational contact may forward a disputed reject request to the nominated Losing C/CSP's representative detailing the Telephone Number and a short explanation of the actual dispute. Each dispute will be allocated a 4-digit sequence number for referencing purposes. The Losing C/CSP will investigate the disputed reject and provide a response by facsimile within four Business hours for simple Porting Requests and two Business Days for complex Porting Requests.

- 10.8.2 If the Gaining C/CSP disputes an ECA reject with the Losing C/CSP, the Gaining C/CSP's operational representative should contact the nominated Losing C/CSP's representative by phone detailing the Telephone Number and a short explanation of the actual dispute. The Losing C/CSP will investigate the disputed ECA reject and provide a verbal response within one hour of the dispute being lodged.
- 10.8.3 Each party will be responsible for updating their own system to reflect the advice provided by the Losing C/CSP.

10.9 Batch Numbering

- 10.9.1 Under Local Number Portability there are two types of batch numbering which relate to the Porting of Complex Telephone Numbers. These are as follows:
 - (a) Batch Reference Number (BRN); and
 - (b) Group Batch Reference Number (GBRN).

10.10 Batch Reference Number (BRN)

- 10.10.1 The BRN is issued by the Gaining C/CSP and is used to advise the Losing C/CSP of a requirement to link all services in a Cat. B or Cat. C Porting Request. The use of BRNs is mandatory in terms of certain business transactions. The use of BRNs in transactions or responses to those transactions where the BRN is not expected should be addressed as part of each bilateral agreement.
- 10.10.2 It is recommended that a C/CSP will use a single list of BRNs to manage Local Number Portability irrespective of the number of bilateral agreements. Therefore, it is proposed that BRNs will be reused once the last BRN is allocated.

10.11 BRN Operational Requirements

- 10.11.1 BRNs will be required whenever Telephone Numbers requiring either a Cat. B Process or Cat. C Process are being Ported irrespective of the actual number of Telephone Numbers in each batch. Batch numbers must only be used when all CNAs relate to an individual customer.
- 10.11.2 The Gaining C/CSP may not add Telephone Numbers to a batch or remove Telephone Numbers from a batch once the CNA has been submitted and the CNA is active. Any subsequent request using different Telephone Numbers but the same BRN will be rejected if that BRN has an outstanding Porting Request.
- 10.11.3 Failure of the Gaining C/CSP to provide a BRN for CNAs will cause the CNA to be rejected.
- 10.11.4 All the Telephone Numbers in a batch have to be managed throughout the Porting process as a single transaction.

10.12 Group Batch Reference Number (GBRN)

- 10.12.1 The GBRN is issued by the Gaining C/CSP where the Gaining C/CSP wishes to group different batches using both Cat. B and/or Cat. C Processes for their own internal uses. The only business transactions that allow GBRNs to be included in a PNO file are CNAs and will not be available in any other transactions including cutover advices, Confirmations, Rejections, Retargets, Withdrawals, Transfer Notifications, Give Backs and Completions.
- 10.12.2 It is recommended that a C/CSP will use a single list of GBRNs to manage Local Number Portability irrespective of the number of bilateral agreements. Therefore, it is proposed that GBRNs will be reused once the last GBRN is allocated.
- 10.12.3 The Losing C/CSP will not validate the GBRN.

11 CUSTOMER COMPLAINTS MANAGEMENT

- 11.1 Customers may raise a complaint with the Losing C/CSP due to LNP activity. In cases where a complaint involves a CA, the Losing C/CSP may request copies of the CAs held by the Gaining C/CSP at the time of the request.
- 11.2 The Losing C/CSP will advise the Gaining C/CSP by facsimile or e-mail of all CA requests due to Customer complaints. Each Telephone Number will be allocated a unique four digit sequence number as a reference. The Gaining C/CSP shall provide copies of all CAs (as originally requested) by facsimile or e-mail. Escalation processes will apply if copies of CAs are not supplied within two Business Days whereby the nominated Gaining C/CSP's escalation representative will be contacted by facsimile or e-mail or another agreed process. In these circumstances the CA must be made available the next Business Day.
- 11.3 If the CA cannot be provided or the CA provided is invalid the Losing C/CSP may, if the customer agrees, request a Port of the Telephone Number back to the Losing C/CSP. In these circumstances the Losing C/CSP will notify the nominated Gaining C/CSP's representative in writing.
- 11.4 If the CA provided is valid and the Customer still wishes to Port to the Losing C/CSP, the Customer must complete a new CA electing that the Losing C/CSP. Standard Porting processes will apply.

12 EMERGENCY PROCESSING

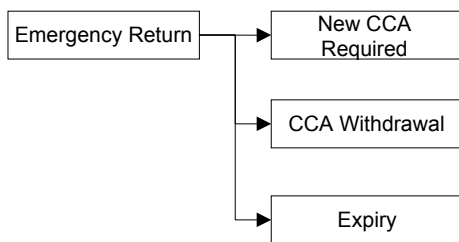
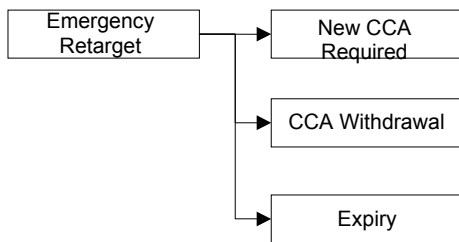
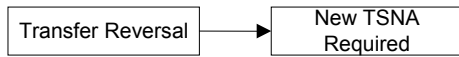
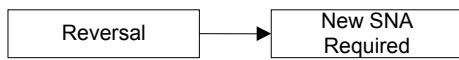

13 GIVEBACK

13.1 Giveback - Context Diagram

The following diagram identifies the agreed transactions that are to be supported for the Giveback Process. A solid line " ← " indicates that the transaction is automated while a broken line " ←..... " indicates that the transaction is manually handled via agreed operational procedures.

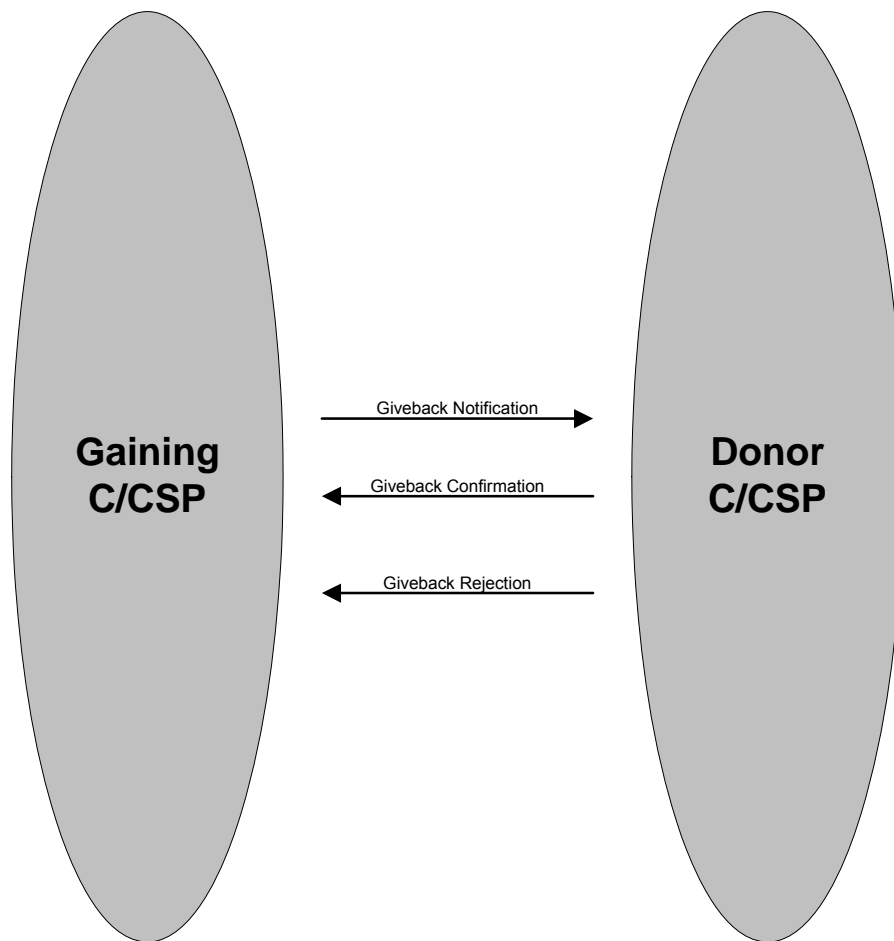

13.2 Giveback - Process Flow Diagrams

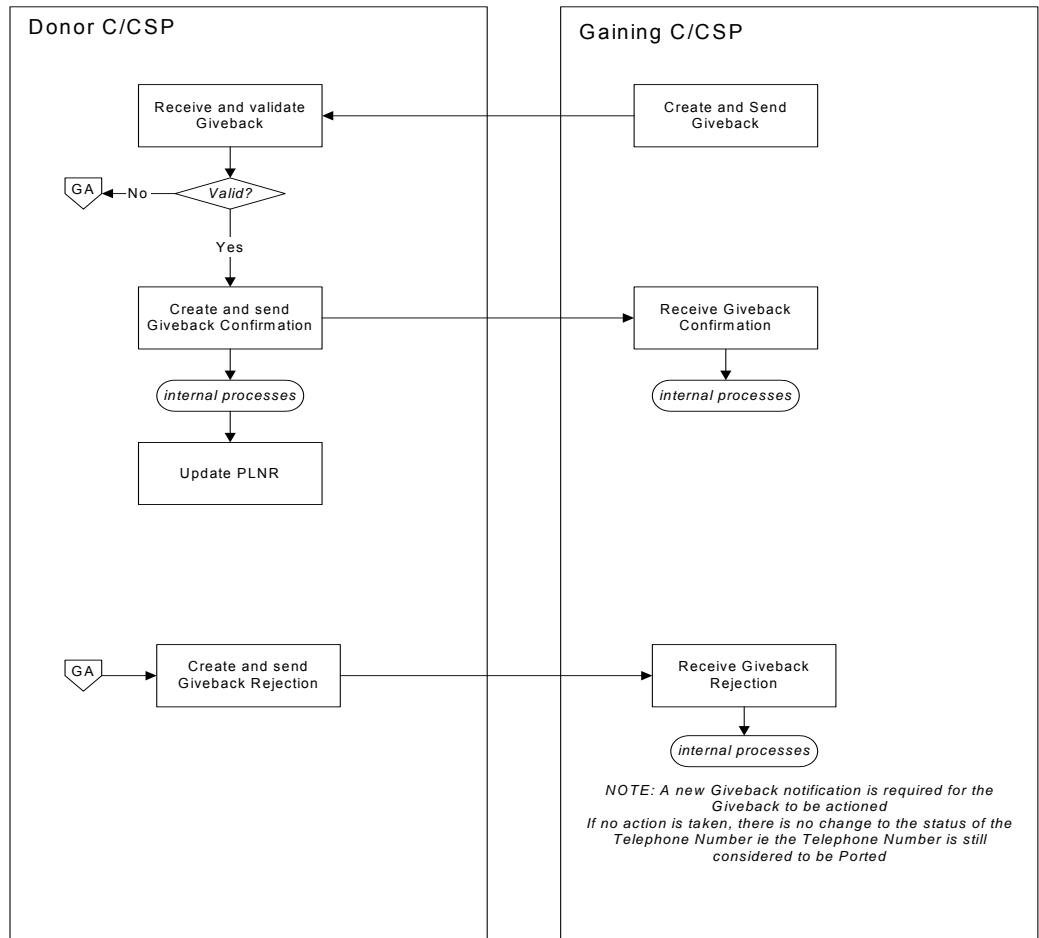

13.3 Giveback – Process Events and Validations

GIVEBACK					
Legend for C/CSP:		G is for Gaining C/CSP D is for Donor C/CSP		Legend for File: D is for Daily PNO H is for Hot Batch	
REF	Event	C/CSP	File	Description	Rules
1	Create and send a Giveback Notification	G	D	Utilised to notify the Donor C/CSP of the Giveback of a Telephone Number i.e. disconnection of number/service.	
	Outcomes and Actions			Giveback Notification included in daily PNO file for forwarding to Donor C/CSP	
2	Receive and validate Giveback Notification	D	D		Donor C/CSP shall validate and reject if: (a) incorrect record format (response code of 020) (b) the Telephone Number given back has not been ported to the C/CSP sending the Giveback Notification (response code of 069) (c) the Telephone Number is not owned by the Donor C/CSP (response code of 069) (d) the Telephone Number is not Ported (response code of 038) (e) the disconnection date is not less than receipt date (response code of 062) (f) all mandatory fields are not populated (response code of 018)
	Outcomes and Actions				
3	Send Giveback Confirmation/Rejection	D	D	Utilised to notify the response of a Giveback Notification.	Donor C/CSP sends Giveback Confirmation/Rejection within one Business Day of receipt of the Giveback Notification
	Outcomes and Actions			Confirmation Update the Ported Local Number Register.	

GIVEBACK					
Legend for C/CSP:		G is for Gaining C/CSP D is for Donor C/CSP		Legend for File: D is for Daily PNO H is for Hot Batch	
REF	Event	C/C SP	File	Description	Rules
4	Receive Giveback Confirmation/ Rejection	G	D		
	Outcomes and Actions			Rejection Internal operational process	
5	Update Ported Local Number Register	D	N/A		The update of the PLNR will replace the existing indicator with a new indicator of "C". The next update of the PLNR will remove the entry from the PLNR.
	Outcomes and Actions			Ported Local Number Register updated	

13.4 Giveback – Porting Timeframes

	Confirmation/ Reject	Receipt Advice	Limit (for confirmations)	Completion	Expiry	Comments
Giveback	N/A	N/A	One	N/A	N/A	Giveback advice to be provided within two Business Days of the cancellation of the service associated with that Telephone Number.

13.5 Giveback – Record Description

Attribute Name	Data Type	Start	Finish	Value	Mandatory	Description
Record Version	NUM(2)	1	2	01	Y	
Record Type	NUM(3)	3	5	060	Y	
Record Identifier	CHAR(3)	6	8	REQ	Y	
Telephone Number	NUM(10)	9	18		Y	Full National Number e.g. 0396342223
Reference	CHAR(9)	19	27		N	Default is spaces
Disconnection Date	DATE(8)	28	35		Y	Format CCYYMMDD.
Nuisance indicator	CHAR(1)	36	36		N	Value is "Y" if Giveback is due to nuisance calls. Default is space.
Filler	CHAR(214)	37	250			

13.6 Giveback Confirmation

Attribute Name	Data Type	Start	Finish	Value	Mandatory	Description
Record Version	NUM(2)	1	2	01	Y	
Record Type	NUM(3)	3	5	060	Y	
Record Identifier	CHAR(3)	6	8	RSP	Y	
Telephone Number	NUM(10)	9	18		Y	Full National Number e.g. 0396342223
Reference	CHAR(9)	19	27		N	Default is spaces
Response Code	NUM(3)	28	30	000	Y	
Filler	CHAR(220)	31	250			

13.7 Giveback Rejection

Attribute Name	Data Type	Start	Finish	Value	Mandatory	Description
Record Version	NUM(2)	1	2	01	Y	
Record Type	NUM(3)	3	5	060	Y	
Record Identifier	CHAR(3)	6	8	RSP	Y	
Telephone Number	NUM(10)	9	18		Y	Full National Number e.g. 0396342223
Reference	CHAR(9)	19	27		N	Default is spaces
Response Code	NUM(3)	28	30		Y	Must be a valid Code from Section 14
Filler	CHAR(220)	31	250			

14 GIVEBACK – RESPONSE CODES

Reject Reason	LNP Reject Description	LNP Further Explanation	Giveback Notification
001	Service Number Not Found	Invalid Service / not present on ASD systems	
002	Service Number is on Diversion	Service is on Network Based Call Diversion i.e. no access line	
003	Inactive Service	Service has been Temporarily Disconnected Customer request	
004	Disconnected Service	Service is Disconnected or Pending Disconnection	
005	Complex Service – e.g. ISDN, Line Hunt etc.		
006	ULLS Call Diversion does not exist on requested Telephone Number		
007	ULLS Number/Telephone Number mismatch		
008	Outstanding porting request	Subsequent request rejected	
009	Porting Already Completed	Porting request received from the current Recipient C/CSP	
010	Telephone Number Ported to Another ASD	Already Ported	
011	ASD Owned Telephone Number	ASD Test Line, etc	
012	Not Used		
013	Not Used		
014	Not Used		
015	Incompatible Exchange Technology	Exchange Equipment or Software Version	
016	Not Used		
017	Telephone Number / Account Mismatch	Notification or Cutover	
018	All mandatory fields are not populated	Mandatory data not provided	√
019	Not Used		
020	Transaction Level Rejections	Incorrectly formatted record	√
021	Not Used		

Reject Reason	LNP Reject Description	LNP Further Explanation	Giveback Notification
022	Not Used		
023	Not Used		
024	Not Used		
025	Not Used		
026	Not Used		
027	Not Used		
028	Losing C/CSP not the Donor C/CSP	Only applicable for Cat-D	
029	ULL request not completed		
030	ULLS call diversion greater than 30 days	ULLS call diversion greater than 30 days, has expired	
031	Not Used		
032	Insufficient notification time frame	Notification or Cutover	
033	Not Used		
034	Cutover outside agreed hours	Agreed hrs 0700 - 1659	
035	No Porting Request is currently outstanding	Porting Notification is not confirmed or has expired	
036	Invalid Cutover Timeslot		
037	Retarget Limit exceeded	Maximum two Retargets only	
038	Giveback Invalid	E.g. Not currently Ported	√
039	Not Used		
040	Duplicate Telephone Number in Batch	There is a Telephone Number duplicated in a single Batch	
041	Multiple Sites	There are more than one site involved for the Telephone Numbers in a Batch	
042	Not Used		
043	Not Used		
044	Not Used		
045	Not Used		
046	Not Used		
047	Not Used		
048	Not Used		

Reject Reason	LNP Reject Description	LNP Further Explanation	Giveback Notification
049	Not Used		
050	Not Used		
051	Telephone Number currently being Ported to another C/CSP		
052	Service is currently connected to the ASD's network		
053	Cutover Date is within the Lead Time		
054	Cutover Date is outside Expiry Date		
055	Invalid Status - CNA Retarget or Withdrawal requested after CCA was Confirmed		
056	Invalid Withdrawal Request		
057	Invalid Retarget Request		
058	Not Used		
059	Not Used		
060	Incomplete Number Block or missing Telephone Numbers in Batch	Incomplete range / batch of service numbers in complex porting request	
061	Batch Reference Number Missing	Complex porting request received without batch number	
062	Giveback Date Invalid	Future dated	√
063	Incorrect Category	Category listed in notification advice is incorrect	
064	Secondary Reject	Porting request is valid for Telephone Number but is associated with a primary reject in the same complex batch	
065	Telephone Numbers are not contiguous for a product		
066	Not Used		
067	Invalid CA date	CA date is too old	
068	Not Used		
069	Donor reject	Incorrect Donor nominated	√
070	Not Used		
071	Not Used		

Reject Reason	LNP Reject Description	LNP Further Explanation	Giveback Notification
072	Not Used		
073	Excluded product	Complex Service cannot be ported	
074	Not Used		
075	Not Used		
076	Not Used		
077	Batch Number NOT unique	Batch Number is being used for another active Port for the same Gaining C/CSP	

15 PORTED LOCAL NUMBER REGISTER

15.1 Ported Local Number Register Purpose

A Ported Local Number Register is maintained by each Donor C/CSP. It is available for all other C/CSPs to read to enable calls to be directed to the correct C/CSP.

All services which are Ported away from the Donor C/CSP are to have an entry on the PLNR, which is used by other C/CSPs to determine the correct routing of calls to Ported Telephone Numbers.

Each Donor C/CSP is responsible for maintaining their own Ported Local Number Register in accordance with the rules for populating the Ported Local Number Register.

Every C/CSP is responsible for reading the Ported Local Number Register of every other C/CSP.

15.2 PLNR Site

The PLNR must be maintained on the Donor C/CSP's website and be password protected.

The website address should be in the format `http://plnr.[orgwebpage]`.

Each Donor C/CSP must register its PLNR with Communications Alliance by providing the full website address of its PLNR to Communications Alliance.

Note: Communications Alliance will maintain a full list of PLNRs on its website.

15.3 PLNR File Type

The PLNR must be stored as an unzipped ASCII text file.

The PLNR must be able to be downloaded automatically by the other C/CSPs.

Only the Donor C/CSP can update their own PLNR on their website.

15.4 Frequency of Update

The PLNR must be updated only once per day before 3:00 am Monday to Saturday, excluding National Public Holidays.

NOTE: The PLNR must be updated even if there has been no change to the individual Telephone Number entries in the file.

15.5 PLNR File Naming Convention

The PLNR file name will be "PLNR".

15.6 PLNR Action Indicators

Action Indicator	Description
blank	if the Telephone Number is Ported prior to current date
A	if the Telephone Number is Ported on the current date (new to the PLNR)
B	if Ported to a new C/CSP under Third Party Porting
C	if the Telephone Number is returned to the donor on the current date (remove from PLNR)
D	if the Telephone Number becomes the subject of a Port pending on the current date
E	if the Telephone Number is still the subject of a Port pending
F	if the pending Port is Rejected, Withdrawn, Expired, Reversed or Emergency Returned on the current date.

15.7 PLNR Access

The PLNR must be published at a directory-accessible fixed FTP or HTTP location. No site navigation should be required to access the PLNR.

The password protection mechanism must allow automated access to the protected resource.

- (a) For FTP, standard username/password authentication suffices.
- (b) For HTTP, the following mechanisms meet the requirement:
 - (i) Standard HTTP basic or digest authentication as defined in RFC2617.
 - (ii) Form-based authentication – if this mechanism is used, the client must be permitted to pass in the required username and password information as POST data in the request to access the URL.

15.8 Accuracy of Ported Local Number Registers

Bilateral Agreements may include procedures for resolving disputes with regard to the accuracy of a Donor C/CSP's Ported Local Number Register.

15.9 Ported Local Number Register Population Rules

15.9.1 Donor as Losing C/CSP

Donor as Losing C/CSP					
Day	Port Request	Porting Activity	Donor PLNR entry Example only	Donor	Network Providers
Day 0	Port initiated	SNA/CNA received	N/A	N/A	N/A
Day 1 to -Day X	Until Port is successfully completed	N/A	N/A	N/A	N/A
Day Y	If Port rejected	Reject completed	N/A	N/A	N/A
Day Y + 1 day	If Port rejected	Reject completed	N/A	N/A	N/A
Day Y	If Port withdrawn	Withdrawal completed	N/A	N/A	N/A
Day Y + 1 day	If Port withdrawn	Withdrawal completed	N/A	N/A	N/A
Day Y	If Port expired	SNA/CNA Expiry completed	N/A	N/A	N/A
Day Y + 1 day	If Port expired	SNA/CNA Expiry completed	N/A	N/A	N/A
Day X	Port Completed and Reversal or Emergency Return requested.	Service reinstated on Donor C/CSP's network	N/A	N/A	N/A

Donor as Losing C/CSP					
Day	Port Request	Porting Activity	Donor PLNR entry Example only	Donor	Network Providers
Day X	Port Completed and Reversal Period or Emergency Return Request Period ended.		090069999999003A	<p>Updates PLNR within two Business Days of Port completion with a new entry for the Telephone Number identifying the Gaining C/CSP and with the action indicator of "A".</p> <p>Provide Donor Transit Routing to the Gaining C/CSP for a period of five Business Days from the date the PLNR was updated with the new entry.</p>	Network Providers route all calls from the Donor C/CSP's network to the Gaining C/CSP's network before the start of business on the day following the update of the PLNR with the new entry.
PLNR update + 1 day & onwards	until another Porting change	-	090069999999003	<p>Updates PLNR entry the next day following the entry of the action indicator of "A" by removing the action indicator of "A", leaving the C/CSP identifier the same.</p> <p>Provide Donor Transit Routing to the specified C/CSP for a period of five Business Days from the date the PLNR was updated with the entry of the action indicator of "A".</p>	Network Providers route all calls from the Donor C/CSP's network to the Gaining C/CSP's network within five Business Days of the PLNR being updated with the entry of the action indicator of "A".

15.9.2 Donor as Gaining C/CSP

Donor as Gaining C/CSP					
Day	Port Request	Porting Activity	Donor PLNR entry Example only	Donor	Network Providers
Day 0	Port initiated	SNA/CNA sent to Losing C/CSP	090069999999001D	<p>Updates PLNR on the same day that the SNA/CNA is sent by the entry of the action indicator of "D", leaving the specified C/CSP identifier the same.</p> <p>Provide Donor Transit Routing to the specified C/CSP's network from the date the PLNR was updated with the entry of the action indicator of "D"</p>	Network Providers route all calls from the specified C/CSP's network to the Donor C/CSP's network before the start of business on the day following the update of the PLNR with the entry of the action indicator of "D".
Day 1 to Day X or Y	until Port is completed, withdrawn or expired		090069999999001E	<p>Updates PLNR the next day by replacing the action indicator of "D" with "E", leaving the specified C/CSP identifier the same.</p> <p>Provide Donor Transit Routing to the specified C/CSP's network.</p>	Network Providers route all calls from the specified C/CSP's network to the Donor C/CSP's network before the start of business on the day following the update of the PLNR with the entry of the action indicator of "E".
Day Y	If Port rejected	Reject completed	090069999999001F	<p>Updates PLNR within two Business days of the Port rejection by replacing the action indicator of "E" with "F", leaving the specified C/CSP identifier the same.</p> <p>Provide Donor Transit Routing to the specified C/CSP's network for a period of five Business days from the date the PLNR was updated with the entry of the action indicator of "F".</p>	Network Providers route all calls from the Donor C/CSP's network to the specified C/CSP's network with five Business days of the PLNR being updated with the entry of the action indicator of "F".

Donor as Gaining C/CSP					
Day	Port Request	Porting Activity	Donor PLNR entry Example only	Donor	Network Providers
Day Y + 1 day	If Port rejected	Reject completed	090069999999001	<p>Updates PLNR entry the next day following the entry of the action indicator of "F" by removing the action indicator of "F", leaving the C/CSP identifier the same.</p> <p>Provide Donor Transit Routing to the specified C/CSP's network for a period of five Business Days from the date the PLNR was updated with the entry of the action indicator of "F".</p>	Network Providers route all calls from the Donor C/CSP's network to the specified C/CSP's network within five Business Days of the PLNR being updated with the entry of the action indicator of "F".
Day Y	If Port withdrawn	Withdrawal completed	090069999999001F	<p>Updates PLNR within two Business days of the Port withdrawal by replacing the action indicator of "E" with "F", leaving the specified C/CSP identifier the same.</p> <p>Provide Donor Transit Routing to the specified C/CSP's network for a period of five Business days from the date the PLNR was updated with the entry of the action indicator of "F".</p>	Network Providers route all calls from the Donor C/CSP's network to the specified C/CSP's network with five Business days of the PLNR being updated with the entry of the action indicator of "F".
Day Y + 1 day	If Port withdrawn	Withdrawal completed	090069999999001	<p>Updates PLNR entry the next day following the entry of the action indicator of "F" by removing the action indicator of "F", leaving the C/CSP identifier the same.</p> <p>Provide Donor Transit Routing to the specified C/CSP's network for a period of five Business Days from the date the PLNR was updated with the entry of the action indicator of "F".</p>	Network Providers route all calls from the Donor C/CSP's network to the specified C/CSP's network within five Business Days of the PLNR being updated with the entry of the action indicator of "F".

Donor as Gaining C/CSP					
Day	Port Request	Porting Activity	Donor PLNR entry Example only	Donor	Network Providers
Day Y	If Port expired	SNA/CNA Expiry completed	090069999999001F	<p>Updates PLNR within two Business days of the Port expiry by replacing the action indicator of "E" with "F", leaving the specified C/CSP identifier the same.</p> <p>Provide Donor Transit Routing to the specified C/CSP's network for a period of five Business days from the date the PLNR was updated with the entry of the action indicator of "F".</p>	<p>Network Providers route all calls from the Donor C/CSP's network to the specified C/CSP's network with five Business days of the PLNR being updated with the entry of the action indicator of "F".</p>
Day Y + 1 day	If Port expired	SNA/CNA Expiry completed	090069999999001	<p>Updates PLNR entry the next day following the entry of the action indicator of "F" by removing the action indicator of "F", leaving the C/CSP identifier the same.</p> <p>Provide Donor Transit Routing to the specified C/CSP's network for a period of five Business Days from the date the PLNR was updated with the entry of the action indicator of "F".</p>	<p>Network Providers route all calls from the Donor C/CSP's network to the specified C/CSP's network within five Business Days of the PLNR being updated with the entry of the action indicator of "F".</p>

Donor as Gaining C/CSP					
Day	Port Request	Porting Activity	Donor PLNR entry Example only	Donor	Network Providers
Day X	Port successfully Completed and Reversal or Emergency Return requested.	<p>Cat. A Process Only.</p> <p>For Cat. B and Cat. C Process, there is no change to the PLNR as the PLNR is only updated after the Port has been completed, withdrawn or expired.</p>	090069999999001F	<p>Updates PLNR within two Business Days of the Port Reversal or Emergency Return by replacing the action indicator of "E" with "F", leaving the specified C/CSP identifier the same.</p> <p>Provide Donor Transit Routing to the specified C/CSP's network for a period of five Business days from the date the PLNR was updated with the entry of the action indicator of "F".</p>	Network Providers route all calls from the Donor C/CSP's network to the specified C/CSP's network with five Business days of the PLNR being updated with the entry of the action indicator of "F".
Day X + 1 day	Port successfully Completed and Reversal or Emergency Return requested.	<p>Cat. A Process Only.</p> <p>For Cat. B and Cat. C Process, there is no change to the PLNR as the PLNR is only updated after the Port has been completed, withdrawn or expired.</p>	090069999999001	<p>Updates PLNR entry the next day following the entry of the action indicator of "F" by removing the action indicator of "F", leaving the C/CSP identifier the same.</p> <p>Provide Donor Transit Routing to the specified C/CSP's network for a period of five Business Days from the date the PLNR was updated with the entry of the action indicator of "F".</p>	Network Providers route all calls from the Donor C/CSP's network to the specified C/CSP's network within five Business Days of the PLNR being updated with the entry of the action indicator of "F".

Donor as Gaining C/CSP					
Day	Port Request	Porting Activity	Donor PLNR entry Example only	Donor	Network Providers
Day X	Port successfully Completed and Reversal Period or Emergency Return Request Period ended.		090069999999002C	<p>Updates PLNR within two Business Days of the Port being completed by replacing the action indicator of "E" with "C", and replacing the specified C/CSP identifier with the Donor C/CSP's identifier.</p> <p>Donor Transit Routing no longer applies.</p>	<p>Network Providers route all calls from the specified C/CSP's network to the Donor C/CSP's network before the start of business on the day following the update of the PLNR with the entry of the action indicator of "C".</p>
PLNR update + 1 days & onwards until there is a change in the Porting status	If Port completed		no entry	<p>Updates PLNR entry the next day following the entry of the action indicator of "C" by removing the total entry from the PLNR.</p> <p>Donor Transit Routing no longer applies.</p>	<p>Network Providers route all calls from the specified C/CSP's network to the Donor C/CSP's network before the start of business on the day following the update of the PLNR with the entry of the action indicator of "C".</p>

15.9.3 Third Party Port

Third Party					
Day	Port Request	Porting Activity	Donor PLNR entry Example only	Donor	Network Providers
Day 0	3rd party Port initiated	TSNA/TCNA received	090069999999003	No action required as a PLNR entry already exists.	N/A
Day Z	If 3rd party Port rejected	TSNA/TCNA rejected	090069999999003	No action required on the PLNR entry.	N/A
Day Z	3rd party Port request confirmed	TSNA/TCNA confirmed	090069999999003D	Update PLNR entry on the same day that the confirmation is sent with the action indicator of "D", leaving the specified C/CSP identifier the same. Provide Donor Transit Routing to the specified C/CSP.	Network Providers route all calls from the specified C/CSP's network to the Donor C/CSP's network by the start of business on the day following the day that the PLNR is updated by the entry of the action indicator of "D".
Day Z + 1 day	3rd party Port request confirmed and until Port is successfully completed	TSNA/TCNA confirmed	090069999999003E	Update PLNR entry by replacing the action indicator of "D" with "E", leaving the specified C/CSP identifier the same. Provide Donor Transit Routing to the specified C/CSP.	Network Providers route all calls from the specified C/CSP's network to the Donor C/CSP's network by the start of business on the day following the day that the PLNR is updated by the entry of the action indicator of "D".

Third Party					
Day	Port Request	Porting Activity	Donor PLNR entry Example only	Donor	Network Providers
Day Y	If 3rd party Port withdrawn	Withdrawal completed	090069999999003F	<p>Updates PLNR within two Business Days of the Port being withdrawn by replacing the action indicator of "E" with "F", leaving the specified C/CSP identifier the same.</p> <p>Provide Donor Transit Routing to the specified C/CSP for a period of five Business Days from the date the PLNR was updated</p>	Network Providers route all calls from the Donor C/CSP's network to the specified C/CSP's network within five Business Days of the PLNR being updated with the entry of the action indicator of "F".
Day Y + 1 day	If 3rd party Port withdrawn	Withdrawal completed	090069999999003	<p>Updates PLNR entry the next day following the entry of the action indicator of "F" by removing the action indicator of "F", leaving the specified C/CSP identifier the same.</p> <p>Provide Donor Transit Routing to the specified C/CSP for a period of five Business Days from the date the PLNR was updated with the entry of the action indicator of "F".</p>	Network Providers route all calls from the Donor C/CSP's network to the specified C/CSP's network within five Business Days of the PLNR being updated with the entry of the action indicator of "F".
Day Y	If 3rd party Port expired	TSNA/TCNA Expiry completed	090069999999003F	<p>Updates PLNR within two Business Days of the Port expiring by replacing the action indicator of "E" with "F", leaving the specified C/CSP identifier the same.</p> <p>Provide Donor Transit Routing to the specified C/CSP for a period of five Business Days from the date the PLNR was updated</p>	Network Providers route all calls from the Donor C/CSP's network to the specified C/CSP's network within five Business days of the PLNR being updated with the entry of the action indicator of "F".

Third Party					
Day	Port Request	Porting Activity	Donor PLNR entry Example only	Donor	Network Providers
Day Y + 1 day	If 3rd party Port expired	TSNA/TCNA Expiry completed	090069999999003	<p>Updates PLNR entry the next day following the entry of the action indicator of "F" by removing the action indicator of "F", leaving the specified C/CSP identifier the same.</p> <p>Provide Donor Transit Routing to the specified C/CSP for a period of five Business Days from the date the PLNR was updated with the entry of the action indicator of "F".</p>	Network Providers route all calls from the Donor C/CSP's network to the specified C/CSP's network within five Business Days of the PLNR being updated with the entry of the action indicator of "F".
Day X	3rd party Port successfully completed and Transfer Reversal or Emergency Return requested.	<p>Cat. A Process Only.</p> <p>For Cat. B and Cat. C Process, there is no change to the PLNR as the PLNR is only updated after the Port has been completed, withdrawn or expired.</p>	090069999999003F	<p>Updates PLNR within two Business Days of the Transfer Reversal or Emergency Return being completed by replacing the action indicator of "E" with "F", leaving the specified C/CSP identifier the same.</p> <p>Provide Donor Transit Routing to the specified C/CSP for a period of five Business Days from the date the PLNR was updated</p>	Network Providers route all calls from the Donor C/CSP's network to the specified C/CSP's network within five Business days of the PLNR being updated with the entry of the action indicator of "F".

Third Party					
Day	Port Request	Porting Activity	Donor PLNR entry Example only	Donor	Network Providers
Day X + 1 day	3rd party Port successfully completed and Transfer Reversal or Emergency Return requested.	Cat. A Process Only. For Cat. B and Cat. C Process, there is no change to the PLNR as the PLNR is only updated after the Port has been completed, withdrawn or expired.	090069999999003	Updates PLNR entry the next day following the entry of the action indicator of "F" by removing the action indicator of "F", leaving the specified C/CSP identifier the same. Provide Donor Transit Routing to the specified C/CSP for a period of five Business Days from the date the PLNR was updated with the entry of the action indicator of "F".	Network Providers route all calls from the Donor C/CSP's network to the specified C/CSP's network within five Business Days of the PLNR being updated with the entry of the action indicator of "F".
Day X	3rd party Port successfully completed and Transfer Reversal Period or Emergency Return Request Period ended.	TECA/TCCA received and completed	090069999999001B	Updates PLNR within two Business Days of the Port being successfully completed by replacing the action indicator of "E" with "B", and replacing the specified C/CSP identifier with the Gaining C/CSP's identifier. Provide Donor Transit Routing to the Gaining C/CSP for a period of five Business Days from the date the PLNR was updated	Network Providers route all calls from the Donor C/CSP's network to the Gaining C/CSP's network within five Business Days of the PLNR being updated with the entry of the action indicator of "B".

Third Party					
Day	Port Request	Porting Activity	Donor PLNR entry Example only	Donor	Network Providers
PLNR update + 1 days & onwards	until another Porting change	-	0900699999999001	<p>Updates PLNR entry the next day following the entry of the action indicator of "B" by removing the action indicator of "B", leaving the C/CSP identifier the same.</p> <p>Provide Donor Transit Routing to the Gaining C/CSP's network for a period of five Business Days from the date the PLNR was updated with the entry of the action indicator of "B".</p>	<p>Network Providers route all calls from the Donor C/CSP's network to the Gaining C/CSP's network within five Business Days of the PLNR being updated with the entry of the action indicator of "B".</p>

15.9.4 Giveback

Giveback					
Day	Port Request	Porting Activity	Donor PLNR entry Example only	Donor	Network Providers
Day 0 to Day X	Giveback initiated	Giveback received and until Giveback completed	090069999999001	No action required as a PLNR entry already exists.	N/A
Day Y + 1 day	If Giveback rejected	Reject completed	090069999999001	No action required on the PLNR entry.	N/A
Day X + 1 day	Giveback completed		090069999999002C	Updates PLNR within two Business Days of Giveback with the action indicator of "C", and replacing the specified C/CSP identifier with the Donor C/CSP's identifier. Donor Transit Routing no longer applies.	Network Providers route all calls from the specified C/CSP's network to the Donor C/CSP's network before the start of business on the day following the update of the PLNR with the entry of the action indicator of "C".
PLNR update + 1 days & onwards			no entry	Updates PLNR entry the next day following the entry of the action indicator of "C" by removing the total entry from the PLNR. Donor Transit Routing no longer applies.	Network Providers route all calls from the specified C/CSP's network to the Donor C/CSP's network before the start of business on the day following the update of the PLNR with the entry of the action indicator of "C".

15.10 Ported Local Number Register – Record Description

15.10.1 Header

Attribute Name	Data Type	Start	Finish	Value	Mandatory	Comment
Record Type	NUM(3)	1	3	001	Y	
Date	DATE(8)	4	11		Y	Format CCYYMMDD This must be the date on which the 03:00 deadline applies and the PLNR must be available for downloading.
C/CSP Creator	NUM(3)	12	14		Y	An industry standard code for each carrier should be used.
Filler	CHAR(3)	15	17			

15.10.2 File Trailer

Attribute Name	Data Type	Start	Finish	Value	Mandatory	Description
Record Type	NUM(3)	1	3	999	Y	
Detail Record Count	NUM(10)	4	13		Y	Value is to equal the number of records of record type 002-998
Filler	CHAR(4)	14	17			

15.10.3 PLNR Entry

Attribute Name	Data Type	Start	Finish	Value	Mandatory	Description
Record Type	NUM(3)	1	3	090	Y	
Telephone Number	NUM(10)	4	13		Y	Full National Number e.g. 0396342223
Gaining C/CSP	NUM (3)	14	16		Y	The three digit numeric Identification Code as per ACIF Eligible Party Identification Code List as allocated under ACIF G600 ACIF Allocation of Eligible Party Identification Codes Industry Guideline.
Action Indicator	CHAR(1)	17	17	See below	Y	Describes the current status of the Ported Number for the purpose of call direction.

16 RESPONSE CODE REFERENCE TABLE

Response Code	Description	LNP Further Explanation
000	Confirmation	
001	Service Number Not Found	Invalid Service / not present on ASD systems
002	Service Number is on Diversion	Service is on Network Based Call Diversion i.e. no access line
003	Inactive Service	Service has been Temporarily Disconnected Customer request
004	Disconnected Service	Service is Disconnected or Pending Disconnection
005	Complex Service – e.g. ISDN, Line Hunt etc.	
006	ULLS Call Diversion does not exist on requested Telephone Number	
007	ULLS Number/Telephone Number mismatch	
008	Outstanding porting request	Subsequent request rejected
009	Porting Already Completed	Porting request received from the current Recipient C/CSP
010	Telephone Number Ported to Another ASD	Already Ported
011	ASD Owned Telephone Number	ASD Test Line, etc
012	Not Used	
013	Not Used	
014	Not Used	
015	Incompatible Exchange Technology	Exchange Equipment or Software Version
016	Not Used	
017	Telephone Number / Account Mismatch	Notification or Cutover
018	All mandatory fields are not populated	Mandatory data not provided
019	Not Used	
020	Transaction Level Rejections	Incorrectly formatted record
021	Not Used	
022	Not Used	
023	Not Used	
024	Not Used	
025	Not Used	
026	Not Used	

Response Code	Description	LNP Further Explanation
027	Not Used	
028	Losing C/CSP not the Donor C/CSP	Only applicable for Cat-D
029	ULL request not completed	
030	ULLS call diversion greater than 30 days	ULLS call diversion greater than 30 days, has expired
031	Not Used	
032	Insufficient notification time frame	Notification or Cutover
033	Not Used	
034	Cutover outside agreed hours	Agreed hrs 0700 - 1659
035	No Porting Request is currently outstanding	Porting Notification is not confirmed or has expired
036	Invalid Cutover Timeslot	
037	Retarget Limit exceeded	Total of two Retargets only
038	Giveback Invalid	e.g. Not currently Ported
039	Not Used	
040	Duplicate Telephone Number in Batch	There is a Telephone Number duplicated in a single Batch
041	Multiple Sites	There are more than one site involved for the Telephone Numbers in a Batch
042	Not Used	
043	Not Used	
044	Not Used	
045	Not Used	
046	Not Used	
047	Not Used	
048	Not Used	
049	Not Used	
050	Not Used	
051	Telephone Number currently being Ported to another C/CSP	
052	Service is currently connected to the ASD's network	
053	Cutover Date is within the Lead Time	
054	Cutover Date is outside Expiry Date	

Response Code	Description	LNP Further Explanation
055	Invalid Status - CNA Retarget or Withdrawal requested after CCA was Confirmed	
056	Invalid Withdrawal Request	
057	Invalid Retarget Request	
058	Not Used	
059	Not Used	
060	Incomplete Number Block or missing Telephone Numbers in Batch	Incomplete range / batch of service numbers in complex porting request
061	Batch Reference Number Missing	Complex porting request received without batch number
062	Giveback Date Invalid	Future dated
063	Incorrect Category	Category listed in notification advice is incorrect
064	Secondary Reject	Porting request is valid for Telephone Number but is associated with a primary reject in the same complex batch
065	Telephone Numbers are not contiguous for a product	
066	Not Used	
067	Invalid CA date	CA date is too old
068	Not Used	
069	Donor reject	Incorrect Donor nominated
070	Not Used	
071	Not Used	
072	Not Used	
073	Excluded product	Complex Service cannot be ported
074	Not Used	
075	Not Used	
076	Not Used	
077	Batch Number NOT unique	Batch Number is being used for another active Port for the same Gaining C/CSP

17 DATA DICTIONARY

Attribute Name	Length	Description/Comment
Account Number	CHAR(25)	<p>The Account Number for which the losing carrier uses for the aggregation of services for a customer for the purposes of billing the customer.</p> <p>Note: Account Number can be different within a batch request.</p>
Batch Reference Number	NUM(9)	<p>Batch Reference Number is utilised to group Telephone Numbers together when they are associated to Cat B or Cat C products.</p> <p>The Batch Reference Number is to be unique for a C/CSP. Unique means the number is not active for another Cat B or C Port and is not an active Cat A reference number for a given C/CSP.</p> <p>Valid values, 9 digits commencing at an agreed number e.g. any value between 0 and 999999999.</p>
CA Date	DATE(8)	<p>The Date the Customer, or their Agent, authorised the Porting of the Telephone Number.</p> <p>Format CCYYMMDD</p>
Cutover Date	DATE(8)	<p>The actual date from which the Telephone Number is to commence the Porting process ie YYYYMMDD</p>
Cutover Timeslot	NUM(4)	<p>For Cat B only and is the start of the agreed Timeslot, i.e. 0800 and 1300, from which the Porting of the Telephone Number is to occur. This is in 24 hr format e.g. 1.00pm is 1300 hrs and is given as Local Time.</p> <p>Other Timeslots may be defined in the Bilateral Agreements.</p>
Commencement Time	NUM(4)	<p>For Cat C the actual local time from which the Telephone Number is to commence the Porting process ie HHMM. This is in 24 hr format e.g. 1.00pm is 1300 hrs</p>
Category Type	CHAR(1)	<p>Used to identify the Category of the Telephone Number to be Ported. It is determined by the Losing C/CSP dependent upon the time and process required to undertake activity to Port the Telephone Number.</p> <p>Definition:</p> <p>Cat. A is a Simple service which can be ready for Porting, using an automated process, within two Business Days of receipt of an SNA, value is 'A'.</p> <p>Cat B is a Telephone Number that can be ready for Porting in the Lead-Time specified by the losing C/CSP. Value is 'B'.</p> <p>Cat C is a Telephone Number that requires a project manager to manage Porting. Value is 'C'.</p> <p>Cat. D is a Simple service which is porting in conjunction with an unconditioned local loop request on an existing service where the Telephone Number has ULLS Call Diversion active, value is 'D'.</p>

Attribute Name	Length	Description/Comment
C/CSP Creator	NUM(3)	The three digit numeric Identification Code as per ACIF Eligible Party Identification Code List as allocated under ACIF G600 ACIF Allocation of Eligible Party Identification Codes Industry Guideline.
C/CSP Receiver	NUM(3)	The three digit numeric Identification Code as per ACIF Eligible Party Identification Code List as allocated under ACIF G600 ACIF Allocation of Eligible Party Identification Codes Industry Guideline.
Creation Date	DATE(8)	Used in the Header to identify the file date. Format CCYYMMDD
Customer's Contact First Name	CHAR(20)	The Customer's First (Given) Name in Upper & Lower case.
Customer's Contact Last Name	CHAR(30)	The Customer's Last (Family) Name in Upper & Lower case.
Customer's Contact Phone Number	NUM(10)	The Customer's Contact full Telephone Number (e.g. 0296644891)
Customer's Contact Fax Number	NUM(10)	The Customer's full Contact Fax Number (e.g. 0299644668).
Customer's Contact Mobile Number	CHAR(10)	The Customer's Contact Mobile Number.
Detail Record Count	NUM(7)	Used in the File Trailer, to identify the number of transactions in the file.
Donor C/CSP Project Manager's First Name	CHAR(20)	The First Name of the Project Manager handling the Project for the Gaining Carrier in Upper & Lower case.
Donor C/CSP Project Manager's Last Name	CHAR(30)	The Last Name of the Project Manager handling the Project for the Donor Carrier in Upper & Lower case.
Donor C/CSP Project Manager's Phone Number	NUM(10)	The Full Telephone Number of the Project Manager handling the Project for the Donor Carrier (e.g. 0296644891).
Donor C/CSP Project Manager's Fax Number	NUM(10)	The full Fax Number of the Project Manager handling the Project for the Donor Carrier (e.g. 0299644668).
Donor C/CSP Project Manager's Mobile Number	CHAR(10)	The Mobile Number of the Project Manager handling the Project for the Donor Carrier.
Exceed SLA Indicator	CHAR(1)	Used to identify those transactions where the Port may not be completed within Activation Targets. Spaces indicate Port will be completed within Activation Targets, "Y" indicates it may not. Valid values: 'Y', or spaces.

Attribute Name	Length	Description/Comment
File Sequence Number	NUM(4)	Used in the Header to uniquely identify the occurrence of a File transmission. This is also used to ensure the daily files are processed in the correct order. Valid values, four digits commencing at an agreed number e.g. 0001. The file sequence number will restart at 0001 when 9999 is reached.
File Type	CHAR(1)	Used in the Header to identify the type. The current valid values are: D – Daily PNO file between C/CSP's H –Hot Batch file between C/CSP's
Gaining C/CSP Project Manager's First Name	CHAR(20)	The First Name of the Project Manager handling the Project for the Gaining Carrier in Upper & Lower case.
Gaining C/CSP Project Manager's Last Name	CHAR(30)	The Last Name of the Project Manager handling the Project for the Gaining Carrier in Upper & Lower case.
Gaining C/CSP Project Manager's Phone Number	NUM(10)	The full Telephone Number of the Project Manager handling the Project for the Gaining Carrier (e.g. 0296644891).
Gaining C/CSP Project Manager's Fax Number	NUM(10)	The full Fax Number of the Project Manager handling the Project for the Gaining Carrier (e.g. 0299644668).
Gaining C/CSP Project Manager's Mobile Number	CHAR(10)	The Mobile Number of the Project Manager handling the Project for the Gaining Carrier.
Group Reference Number	NUM(4)	Issued by the Gaining C/CSP. Used on business transactions where the notification is to advise the Losing C/CSP of multiple requests that need to cutover on the same day, but possibly at different times. Must only belong to the one customer and contain at least one Cat. C batch. Format unique four digits sequence number. The Losing or Donor C/CSP will validate: - Group Reference Number is not active for another Porting Request sent by the Gaining C/CSP. - Group Reference Number is numeric
Lead Time	NUM(2)	Used by the Losing C/CSP to notify the Gaining C/CSP of the Lead-Time required to prepare a Cat. B Telephone Number for Porting. The unit in days.
Losing C/CSP Project Manager's First Name	CHAR(20)	The First Name of the Project Manager handling the Project for the Losing Carrier in Upper & Lower case.

Attribute Name	Length	Description/Comment
Losing C/CSP Project Manager's Last Name	CHAR(30)	The Last Name of the Project Manager handling the Project for the Losing Carrier in Upper & Lower case.
Losing C/CSP Project Manager's Phone Number	NUM(10)	The full Telephone Number of the Project Manager handling the Project for the Losing Carrier (e.g. 0296644891).
Losing C/CSP Project Manager's Fax Number	NUM(10)	The full Fax Number of the Project Manager handling the Project for the Losing Carrier (e.g. 0299644668).
Losing C/CSP Project Manager's Mobile Number	CHAR(10)	The Mobile Number of the Project Manager handling the Project for the Losing Carrier.
Record Identifier	CHAR(3)	Used to identify the record as a Request or a Response. Valid values 'REQ', 'RSP', or 'ACK'.
Record Type	NUM(3)	Used to identify the Record Type ('999' used to indicate end of file in the File Trailer)
Record Version	NUM(2)	Used to identify the version of the Record Type.
Reference	CHAR(9)	Reference is utilised as an operational reference number for Cat A and Cat D Ports. The reference is not unique.
Response Code	NUM(3)	Value "000" identifies that the request has been accepted, a numeric value other than "000" means the request has been rejected. The non "000" value is the reject response code.
Telephone Number	NUM(10)	A Customer Access Number that is declared Portable in the Numbering Plan relating to Local Number Portability (e.g. 0396342223)
Time Zone	NUM(4)	Time zone specified in GMT difference using HHMM format (e.g. EST Sydney = 1000, non daylight saving for Perth = 0800)
ULL Service Number	NUM(10)	ULL Service Number is utilised as an operational reference for a complete path of communications wire that runs from an exchange or rim to a customer's premises.

18 BATCH VALIDATION EXAMPLES

Validations on an initial receipt of a CNA request will be done at the Telephone Number level. Confirmation will be at batch level whilst rejection will be at Telephone Number level.

The following are examples of how the response codes are to be assigned.

18.1 Service example

The illustration below is a simple example of six different Telephone Numbers being associated to two different products, X and B. The scenarios below will outline some possible request combinations

Product	X	Y
Category Type	B	C
Telephone Numbers	0999990001	0999990004
	0999990002	0999990005
	0999990003	0999990006

The Gaining C/CSP sends a CNA notification to the Losing C/CSP. For these examples the relevant attributes are Account Number, Batch Reference Number, Telephone Number and Category Type.

18.2 Scenario 1

The CNA is received with only two out of the three Telephone Numbers identified in the batch, as illustrated in the table below.

Batch Reference No	Account No	Telephone No	Batch Category Type
111111111	222222222222	0999990001	B
111111111	222222222222	0999990002	B

The CNA rejection will identify that the batch is incomplete e.g. 60

Batch Reference No	Telephone No	Response code
111111111	0999990001	060
111111111	0999990002	060

18.3 Scenario 2

The CNA is received with three out of the three Telephone Numbers for product X identified in the batch and with some Telephone Numbers from another product B, as illustrated in the table below.

Batch Reference No	Account No	Telephone No	Batch Category Type
111111111	222222222222	0999990001	C
111111111	222222222222	0999990002	C
111111111	222222222222	0999990003	C
111111111	222222222222	0999990004	C
111111111	222222222222	0999990005	C

Validation of the batch will initially identify the Telephone Numbers for product X are all present in the batch. The Telephone Number for product Y are not all present in the batch and each Telephone Number for product Y will be rejected with response code "060".

Because some of the Telephone Numbers in the batch have been rejected, the remaining Telephone Numbers in the batch must be rejected with response code "064" which identifies the Telephone Number as valid but that other Telephone Numbers in the batch have been rejected.

Batch Reference No	Telephone No	Response code
111111111	0999990001	064
111111111	0999990002	064
111111111	0999990003	064
111111111	0999990004	060
111111111	0999990005	060

18.4 Scenario 3

The CNA is received with three out of the three Telephone Numbers for product X and three out of the three Telephone Numbers for product Y in the batch but with the records not contiguous for each product, as illustrated in the table below;

Batch Reference No	Account No	Telephone No	Batch Category Type
111111111	2222	0999990001	C
111111111	2222	0999990002	C
111111111	3333	0999990004	C
111111111	2222	0999990003	C
111111111	3333	0999990005	C
111111111	3333	0999990006	C

Because the Telephones Numbers are not contiguous for either product, the Telephone Numbers for both products will be rejected with response code "065".

Batch Reference No	Telephone No	Response code
111111111	0999990001	065
111111111	0999990002	065
111111111	0999990004	065
111111111	0999990003	065
111111111	0999990005	065
111111111	0999990006	065

18.5 Scenario 4

The CNA is received with three out of the three Telephone Numbers for product X and three out of the three Telephone Numbers for product Y in the batch but with the records not contiguous for product B, as illustrated in the table below;

Batch Reference No	Account No	Telephone No	Batch Category Type
111111111	3333	0999990004	C
111111111	2222	0999990001	C
111111111	2222	0999990002	C
111111111	2222	0999990003	C
111111111	3333	0999990005	C

Batch Reference No	Account No	Telephone No	Batch Category Type
111111111	3333	0999990006	C

Validation of the batch will initially identify the Telephone Numbers for product X are all present in the batch. The Telephone Numbers for product Y are all present in the batch but are not contiguous in the batch and each Telephone Number for product Y will be rejected with response code "065".

Because some of the Telephone Numbers in the batch have been rejected, the remaining Telephone Numbers in the batch must be rejected with response code "064" which identifies the Telephone Number as valid but that other Telephone Numbers in the batch have been rejected.

Batch Reference No	Telephone No	Response code
111111111	0999990004	065
111111111	0999990001	064
111111111	0999990002	064
111111111	0999990003	064
111111111	0999990005	065
111111111	0999990006	065

18.6 Scenario 5

The CNA is received with three out of the three Telephone Numbers for product X and three out of the three Telephone Numbers for product Y in the batch but with an additional "duplicate" Telephone Number for product B, as illustrated in the table below;

Batch Reference No	Account No	Telephone No	Batch Category Type
111111111	3333	0999990004	C
111111111	2222	0999990001	C
111111111	2222	0999990002	C
111111111	2222	0999990003	C
111111111	3333	0999990004	C
111111111	3333	0999990005	C
111111111	3333	0999990006	C

Validation of the batch will identify the first Telephone Number as belonging to product Y and that the Telephone Numbers for product Y are all present in the batch but are not contiguous. Therefore all the Telephone Numbers for product Y are rejected with response code "065".

The second occurrence of Telephone Number "0999990004" is rejected as a duplicate with response code "040".

All the Telephone Numbers for product X are present and contiguous and are therefore valid. However as another Telephone Number in the batch has been rejected, they will have a response code of "064".

Batch Reference No	Telephone No	Response code
111111111	0999990004	065
111111111	0999990001	064
111111111	0999990002	064
111111111	0999990003	064
111111111	0999990004	040
111111111	0999990005	065
111111111	0999990006	065

Communications Alliance was formed in 2006 to provide a unified voice for the Australian communications industry and to lead it into the next generation of converging networks, technologies and services.

In pursuing its goals, Communications Alliance offers a forum for the industry to make coherent and constructive contributions to policy development and debate.

Communications Alliance seeks to facilitate open, effective and ethical competition between service providers while ensuring efficient, safe operation of networks, the provision of innovative services and the enhancement of consumer outcomes.

It is committed to the achievement of the policy objective of the Telecommunications Act 1997 - the greatest practicable use of industry self-regulation without imposing undue financial and administrative burdens on industry.



Published by:
COMMUNICATIONS
ALLIANCE LTD

Level 9
32 Walker Street
North Sydney
NSW 2060 Australia

Correspondence
PO Box 444
Milsons Point
NSW 1565

T 61 2 9959 9111
F 61 2 9954 6136
TTY 61 2 9923 1911
E info@commsalliance.com.au
www.commsalliance.com.au
ABN 56 078 026 507

Care should be taken to ensure the material used is from the current version of the Standard or Industry Code and that it is updated whenever the Standard or Code is amended or revised. The number and date of the Standard or Code should therefore be clearly identified. If in doubt please contact Communications Alliance