

**COMMUNICATIONS
ALLIANCE LTD**



INDUSTRY GUIDELINE
ACIF G602.4:2007
LOCAL NUMBER PORTABILITY
IT SPECIFICATIONS AND OPERATIONS MANUAL
PART 4 – CATEGORY C PROCESSING

**ACIF G602.4:2007 Local Number Portability
IT Specifications and Operations Manual Part 4 –
Category C Processing Industry Guideline**

First published as ACIF G602.4:2003

Second edition as ACIF G602.5:2005

Third edition as ACIF G602.5:2006

Fourth edition as ACIF G602.5:2007

Communications Alliance Ltd was formed in 2006 to provide a unified voice for the Australian communications industry and to lead it into the next generation of converging networks, technologies and services. ACIF is a division of Communications Alliance.

Disclaimers

1. Notwithstanding anything contained in this Industry Guideline:
 - (a) ACIF disclaims responsibility (including where ACIF or any of its officers, employees, agents or contractors has been negligent) for any direct or indirect loss, damage, claim, or liability any person may incur as a result of any:
 - (i) reliance on or compliance with this Industry Guideline;
 - (ii) inaccuracy or inappropriateness of this Industry Guideline; or
 - (iii) inconsistency of this Industry Guideline with any law; and
 - (b) ACIF disclaims responsibility (including where ACIF or any of its officers, employees, agents or contractors has been negligent) for ensuring compliance by any person with this Industry Guideline.
2. The above disclaimers will not apply to the extent they are inconsistent with any relevant legislation.

Copyright

© Australian Communications Industry Forum Limited 2007

This document is copyright and must not be used except as permitted below or under the *Copyright Act 1968*. You may reproduce and publish this document in whole or in part for your or your organisation's own personal or internal compliance, educational or non-commercial purposes. You must not alter or amend this document in any way. You must not reproduce or publish this document for commercial gain without the prior written consent of ACIF. Organisations wishing to reproduce or publish this document for commercial gain (i.e. for distribution to subscribers to an information service) may apply to subscribe to the *ACIF Publications Subscription Service* by contacting the ACIF Business Manager at acif@acif.org.au. If you publish any part of this document for any purpose, you must also publish this copyright notice as part of that publication.

PARTICIPANTS

The Working Committee responsible for the revisions made to this Guideline consisted of the following organisations and their representatives:

Organisation	Membership	Representative
AAPT	Voting	Brian Chapman
ACMA	Non-voting	Gerry O'Reilly
ACMA	Non-voting	Greg Neylan
ACCC	Non-voting	Grant Young
Hutchison Telecoms	Voting	Brian Currie
Hutchison Telecoms	Non-voting	Alexander R Osborne
Verizon Business	Voting	Sean Barkley
Optus	Voting	Chris Tan
Paradigm.One	Voting	Dev Gupta
PowerTel	Voting	Geoff Brann
Telstra	Voting	Terry Dyer
TransAct	Non-voting	Wayne Bouffler

This Working Committee was chaired by Alexander R Osborne. James Duck of ACIF provided project management support.

TABLE OF CONTENTS

1	CAT. C - CONTEXT DIAGRAMS	3
1.1	Cat. C - Donor as Losing C/CSP	3
1.2	Cat. C - Donor as Gaining C/CSP	4
1.3	Cat. C - Third Party	4
2	CAT. C - TRANSACTION TREES	5
2.1	Cat. C – Donor as Losing C/CSP	5
2.2	Cat. C – Donor as Gaining C/CSP	5
2.3	Cat. C - Third Party	5
3	CAT. C – LIFETIME OF PORT	6
3.1	Cat. C - Donor as Losing C/CSP	6
3.2	Cat. C - Donor as Gaining C/CSP	6
3.3	Cat. C – Third Party	7
4	CAT. C – PROCESS FLOW DIAGRAMS	8
4.1	Cat. C – Donor as Losing C/CSP	8
4.2	Cat. C – Donor as Gaining C/CSP	16
4.3	Cat. C – Third Party	25
5	CAT. C – PROCESS EVENTS AND VALIDATIONS	34
5.1	Cat. C - Donor as Losing C/CSP	34
5.2	Cat. C - Donor as Gaining C/CSP	45
5.3	Cat. C - Third Party	57
6	CAT. C – THIRD PARTY PORT ACTIVITY	77
6.1	Port Initiated	77
6.2	Port Cutover	77
6.3	CCA/TCCA Retarget	78
6.4	CNA/TCNA Withdrawal	79
6.5	CCA/TCCA Withdrawal	79
6.6	Port Expiry	80
7	CAT. C – PORTING TIME FRAMES	81
8	CAT. C – RECORD DESCRIPTION	82
8.1	CNA Port Notification	82
8.2	CNA Batch Receipt	83
8.3	CNA Port Notification Confirmation	84
8.4	CNA Port Notification Rejection	84
8.5	CNA Withdrawal Notification	85
8.6	CNA Withdrawal Confirmation	85
8.7	CNA Withdrawal Rejection	85
8.8	CCA Cutover Notification	86

8.9	CCA Cutover Batch Receipt	86
8.10	CCA Cutover Notification Confirmation	86
8.11	CCA Cutover Notification Rejection	87
8.12	CCA Retarget Notification	87
8.13	CCA Retarget Receipt	87
8.14	CCA Retarget Confirmation	88
8.15	CCA Retarget Rejection	88
8.16	CCA Withdrawal Notification	88
8.17	CCA Withdrawal Confirmation	89
8.18	CCA Withdrawal Rejection	89
8.19	CNA Expiry Notification	89
8.20	TCNA Port Notification	90
8.21	TCNA Port Notification Batch Receipt	90
8.22	TCNA Port Notification Confirmation	91
8.23	TCNA Port Notification Rejection	91
8.24	TCNA Withdrawal Notification	92
8.25	TCNA Withdrawal Confirmation	92
8.26	TCNA Withdrawal Rejection	92
8.27	TCCA Cutover Notification	93
8.28	TCCA Cutover Batch Receipt	93
8.29	TCCA Cutover Confirmation	93
8.30	TCCA Cutover Rejection	94
8.31	TCCA Retarget Notification	94
8.32	TCCA Retarget Receipt	94
8.33	TCCA Retarget Confirmation	95
8.34	TCCA Retarget Rejection	95
8.35	TCCA Withdrawal Notification	95
8.36	TCCA Withdrawal Confirmation	96
8.37	TCCA Withdrawal Rejection	96
8.38	TCNA Expiry Notification	96
<hr/>		
9	CAT. C – RESPONSE CODES	97
<hr/>		

1 CAT. C - CONTEXT DIAGRAMS

The following diagrams identify the agreed transactions that are to be supported for the Cat. C Process. A solid line " ←—————" indicates that the transaction is automated while a broken line " ←- - - - -" indicates that the transaction is manually handled via agreed operational procedures.

1.1 Cat. C - Donor as Losing C/CSP

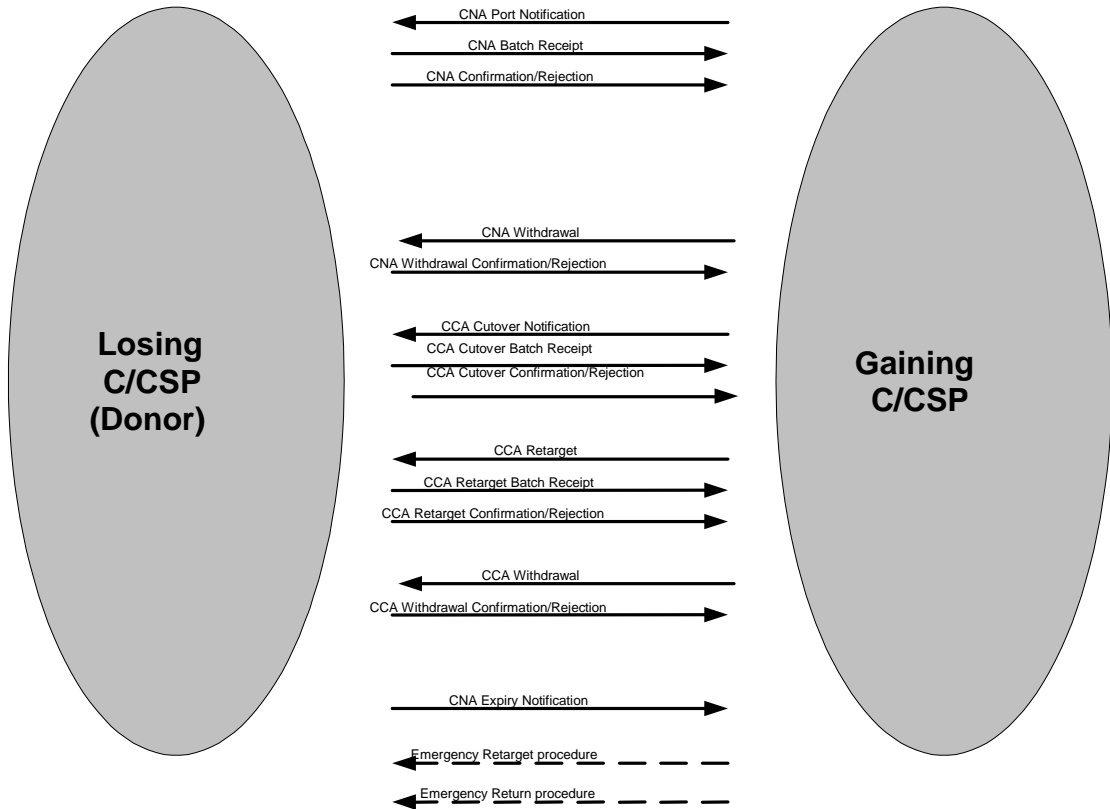

1.2 Cat. C - Donor as Gaining C/CSP

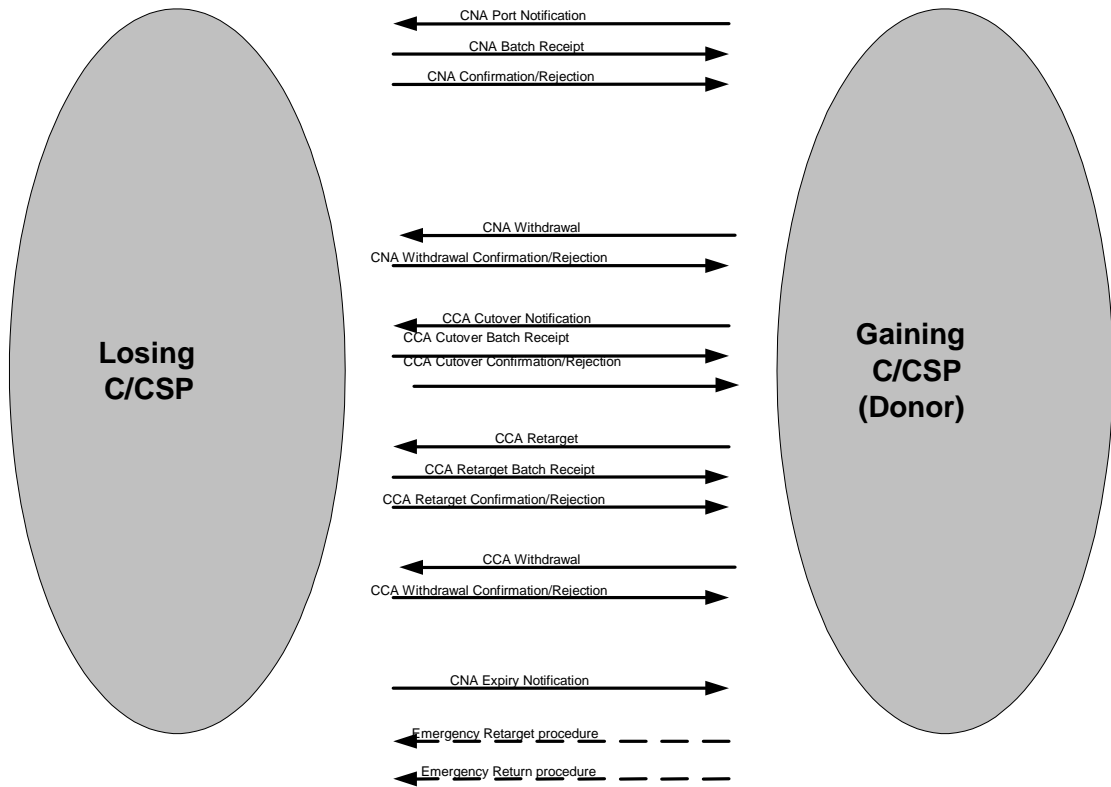

1.3 Cat. C - Third Party

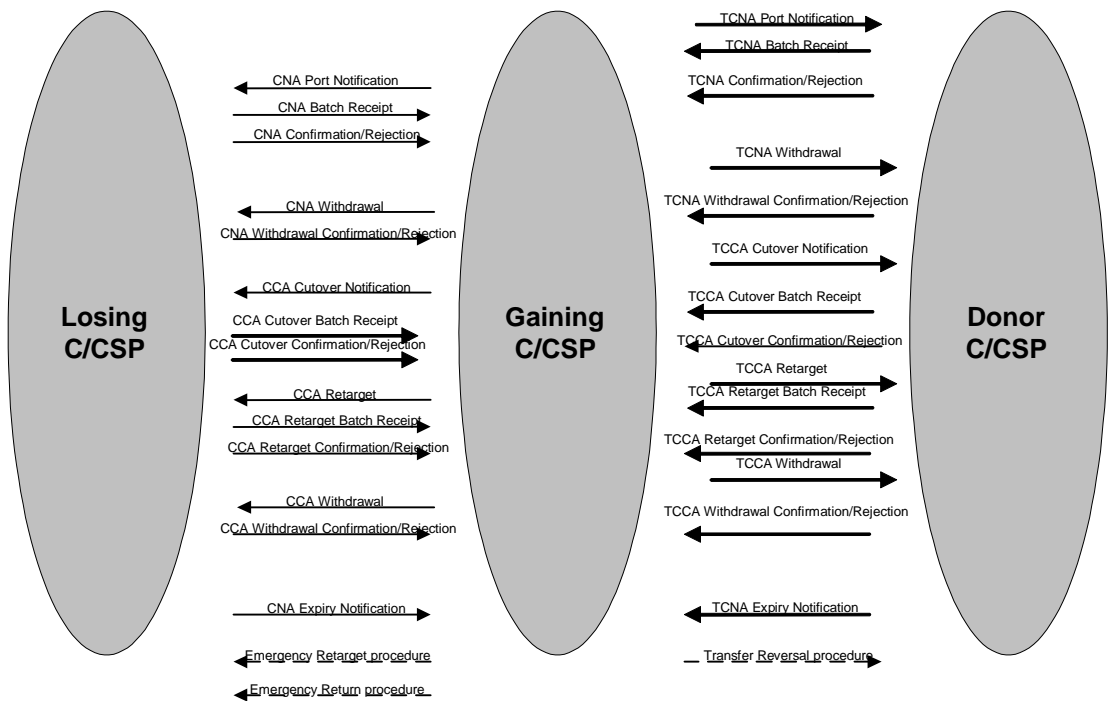

2 CAT. C - TRANSACTION TREES

2.1 Cat. C – Donor as Losing C/CSP

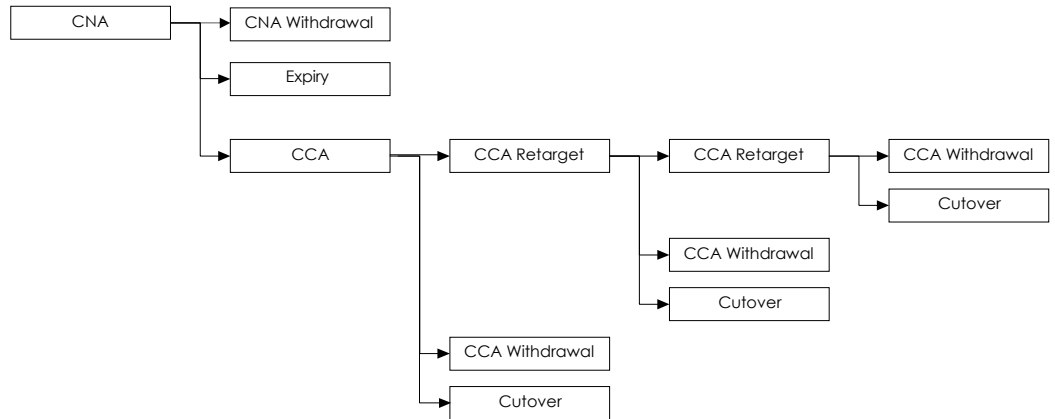

2.2 Cat. C – Donor as Gaining C/CSP

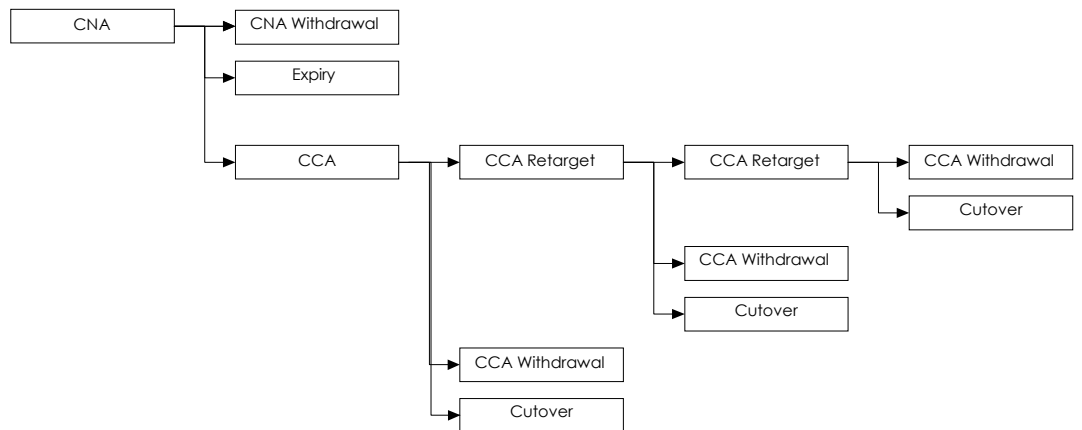

2.3 Cat. C - Third Party

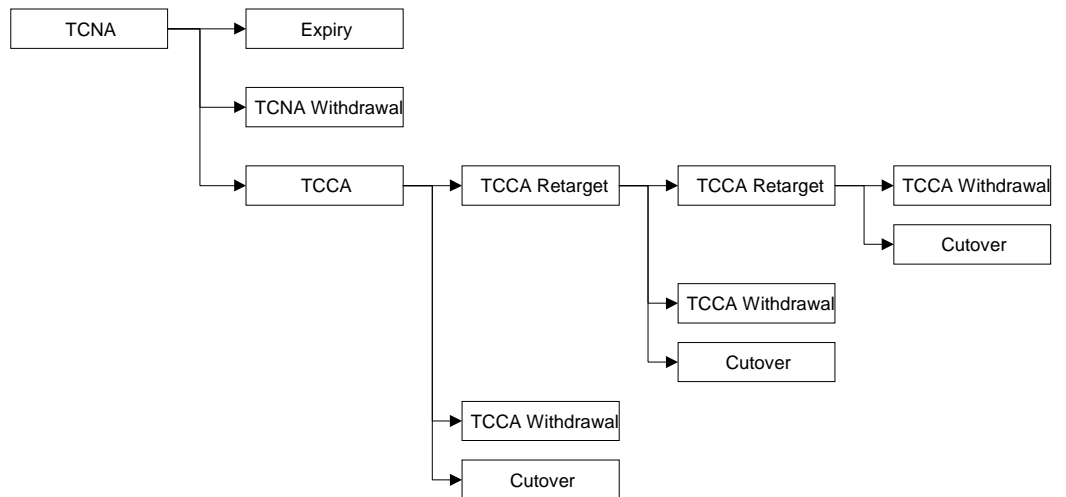

3 CAT. C – LIFETIME OF PORT

3.1 Cat. C - Donor as Losing C/CSP

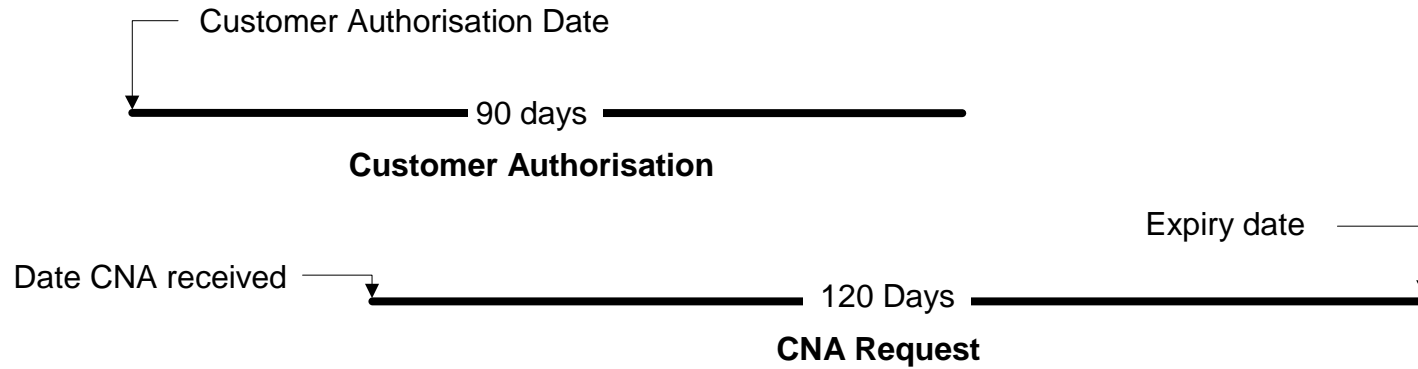

3.2 Cat. C - Donor as Gaining C/CSP

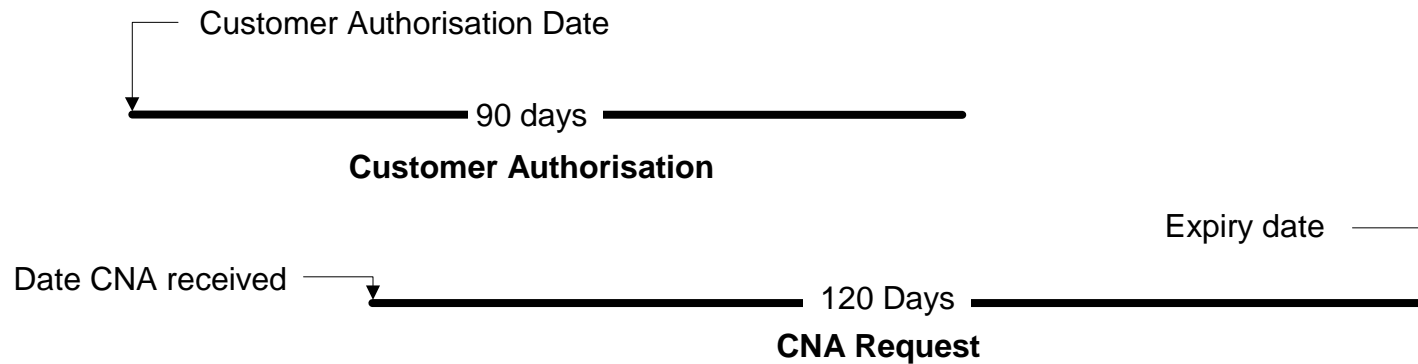

3.3 Cat. C – Third Party

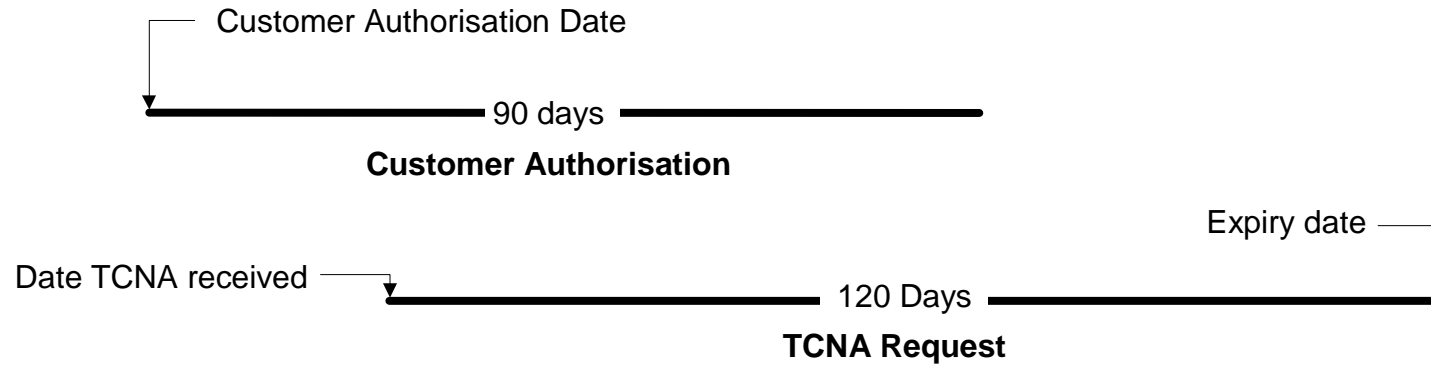

4 CAT. C – PROCESS FLOW DIAGRAMS

4.1 Cat. C – Donor as Losing C/CSP

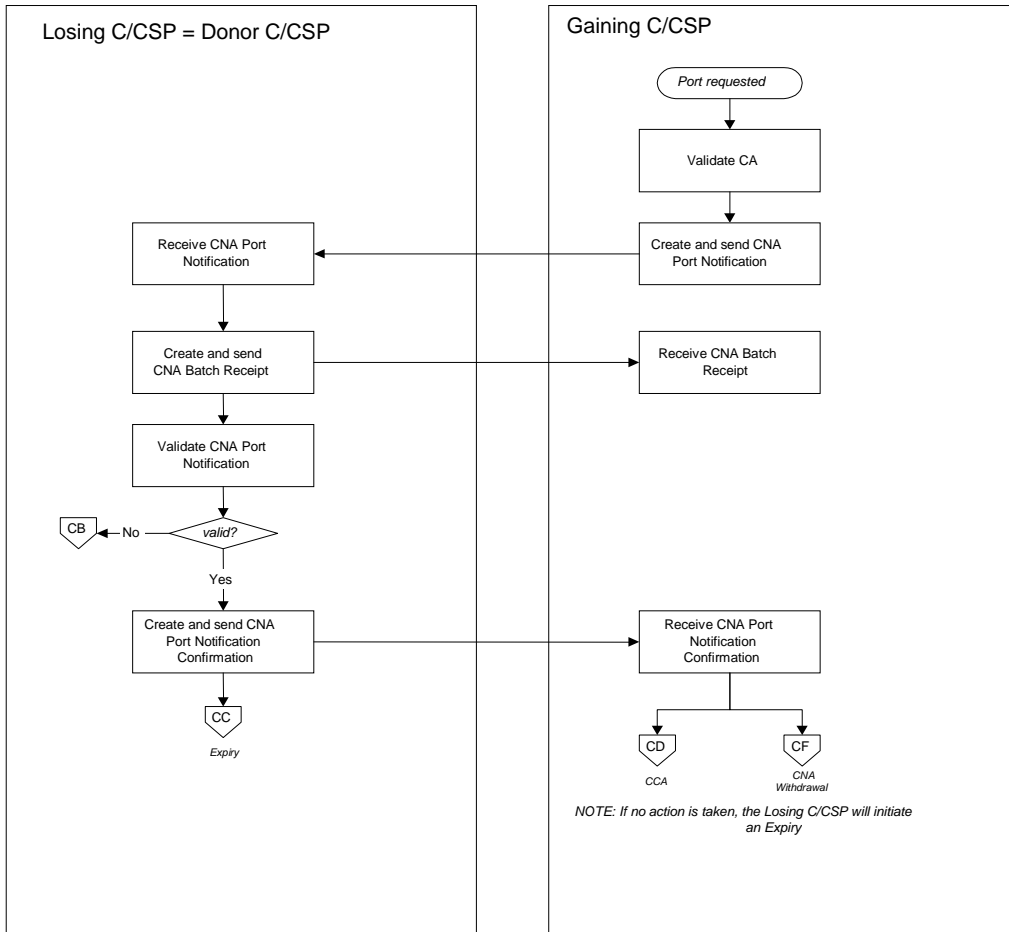

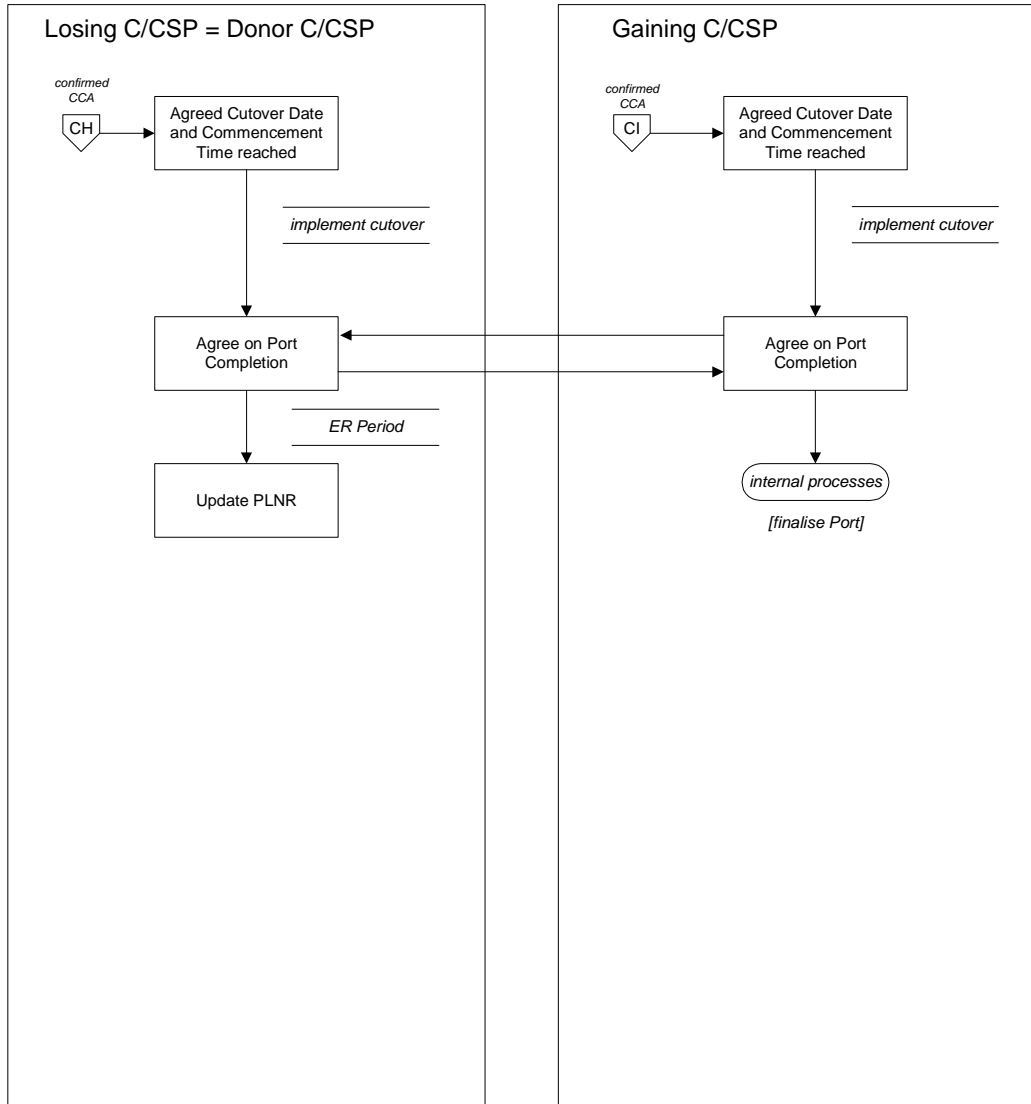

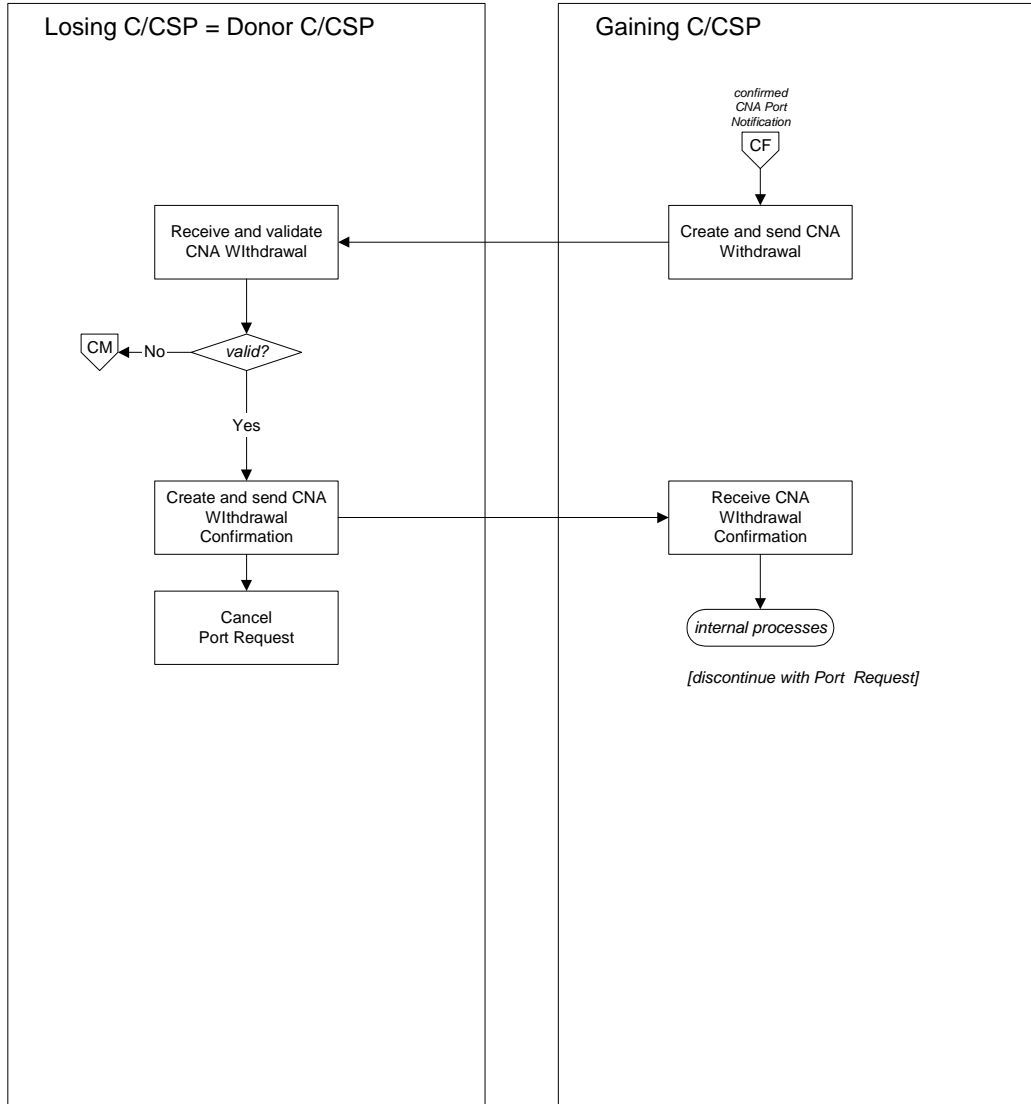

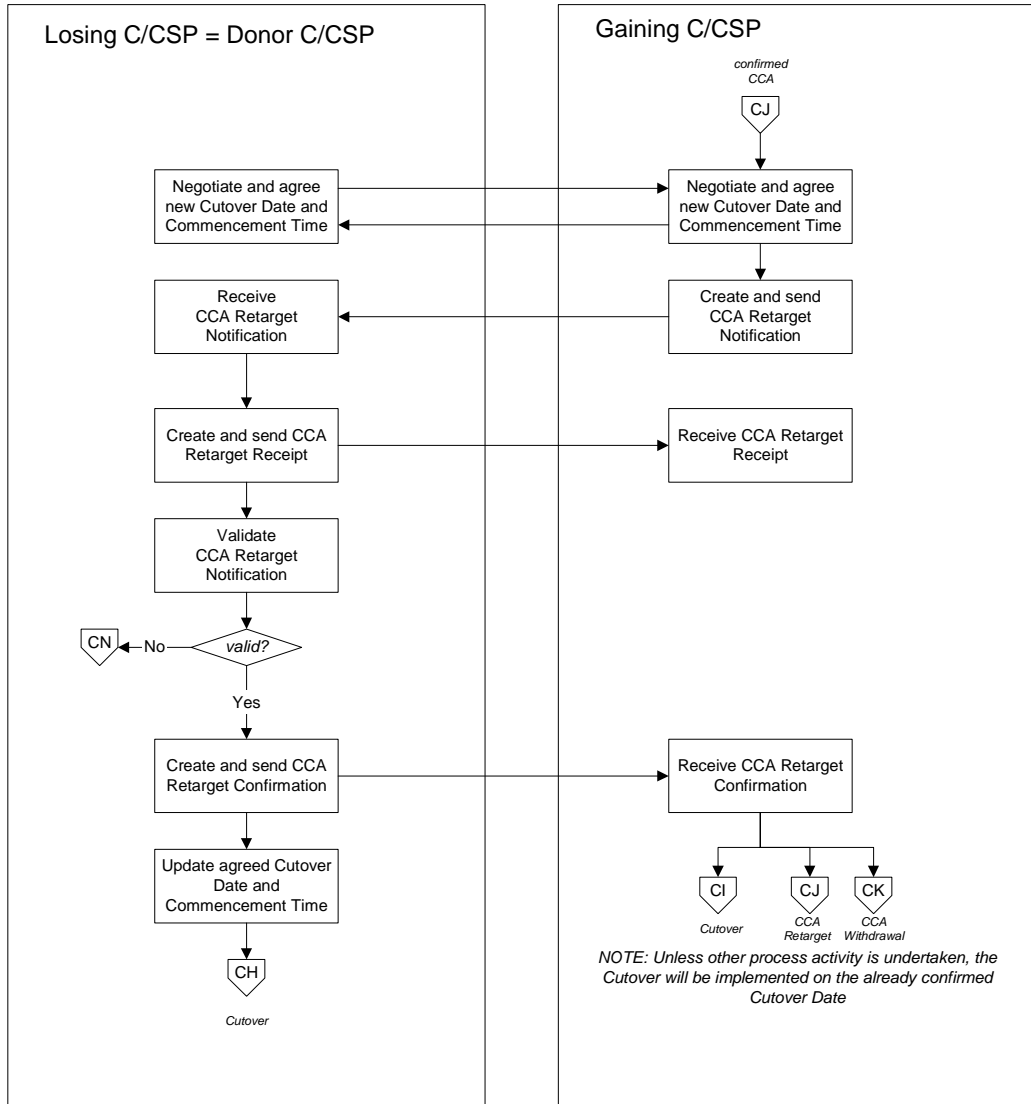

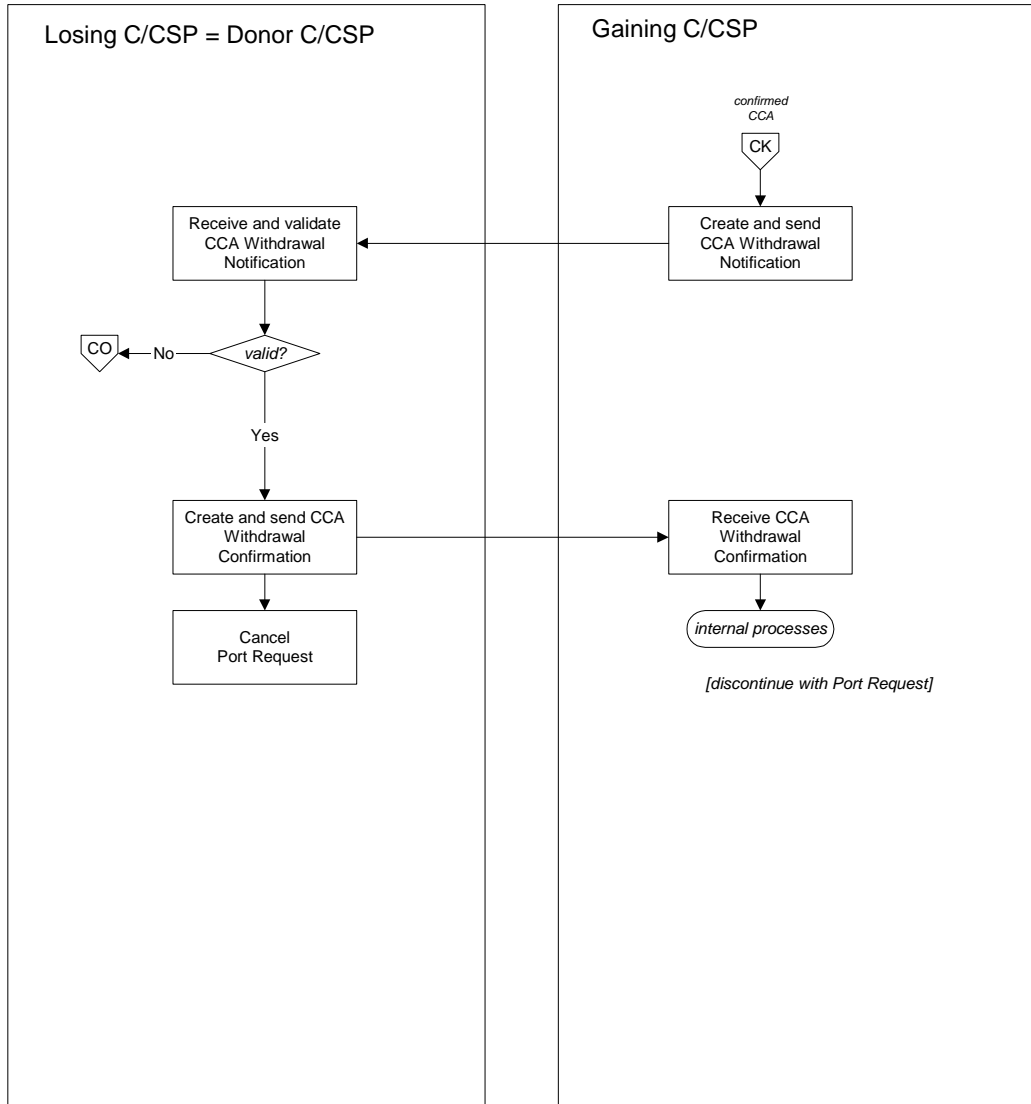

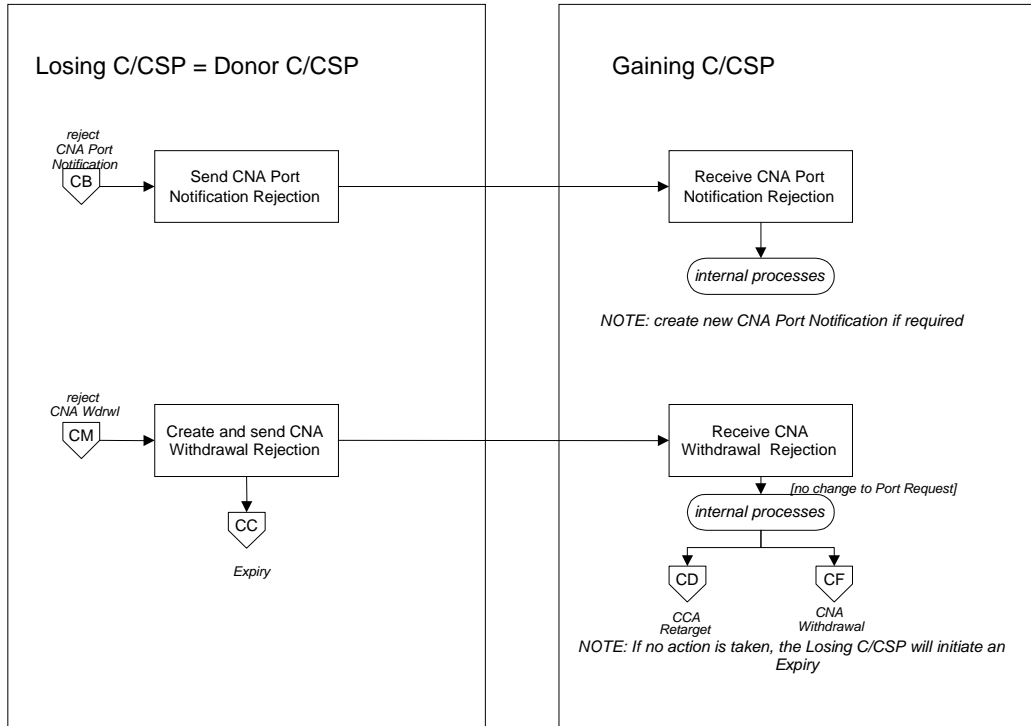

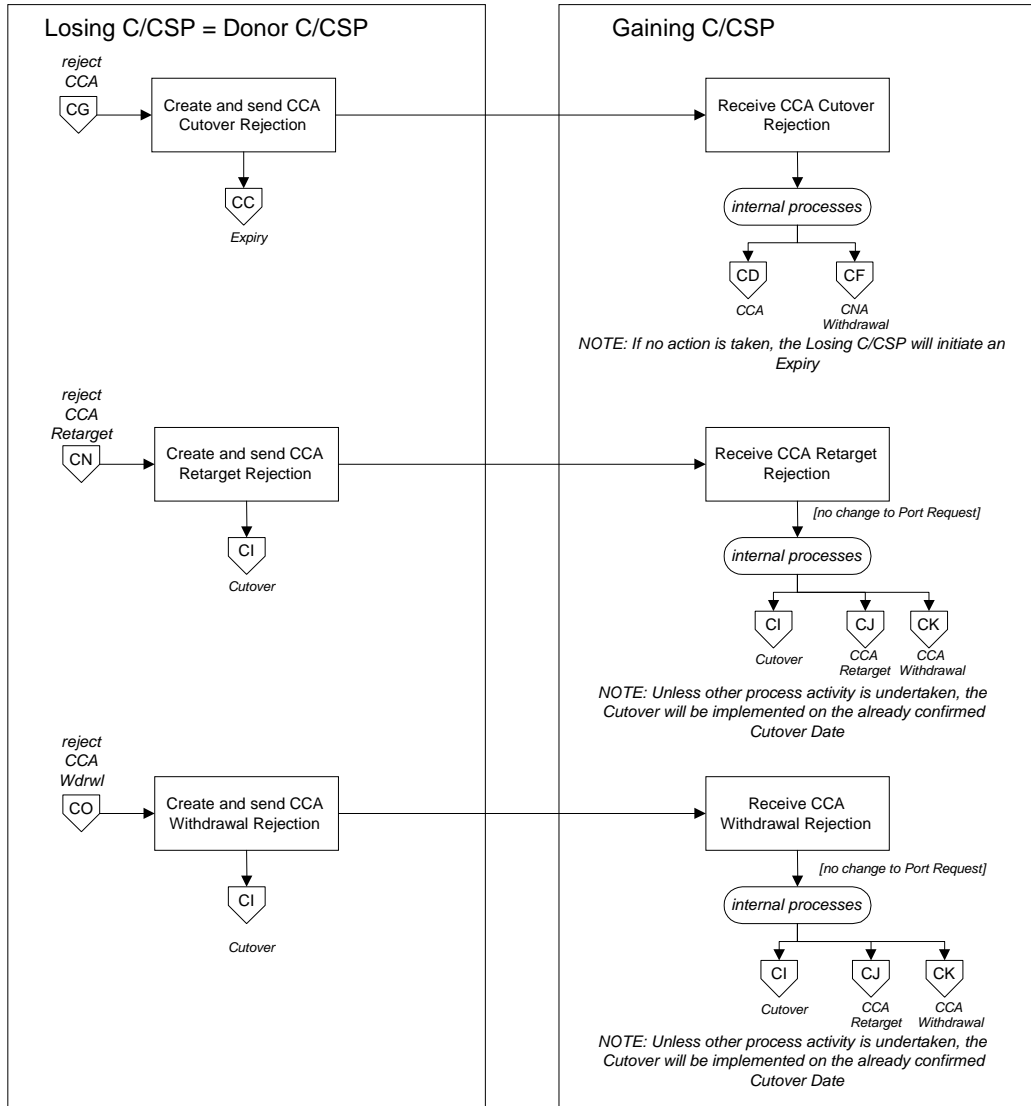

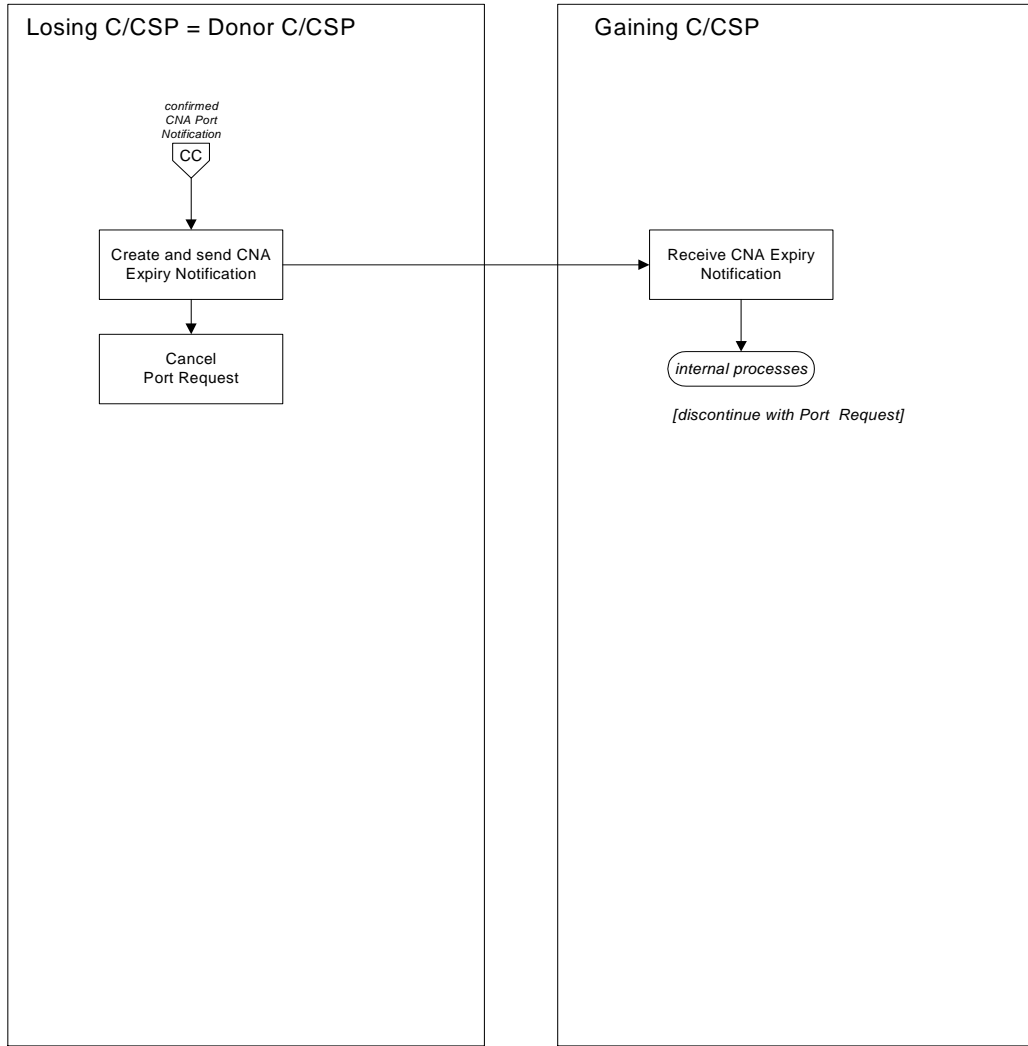

4.2 Cat. C – Donor as Gaining C/CSP

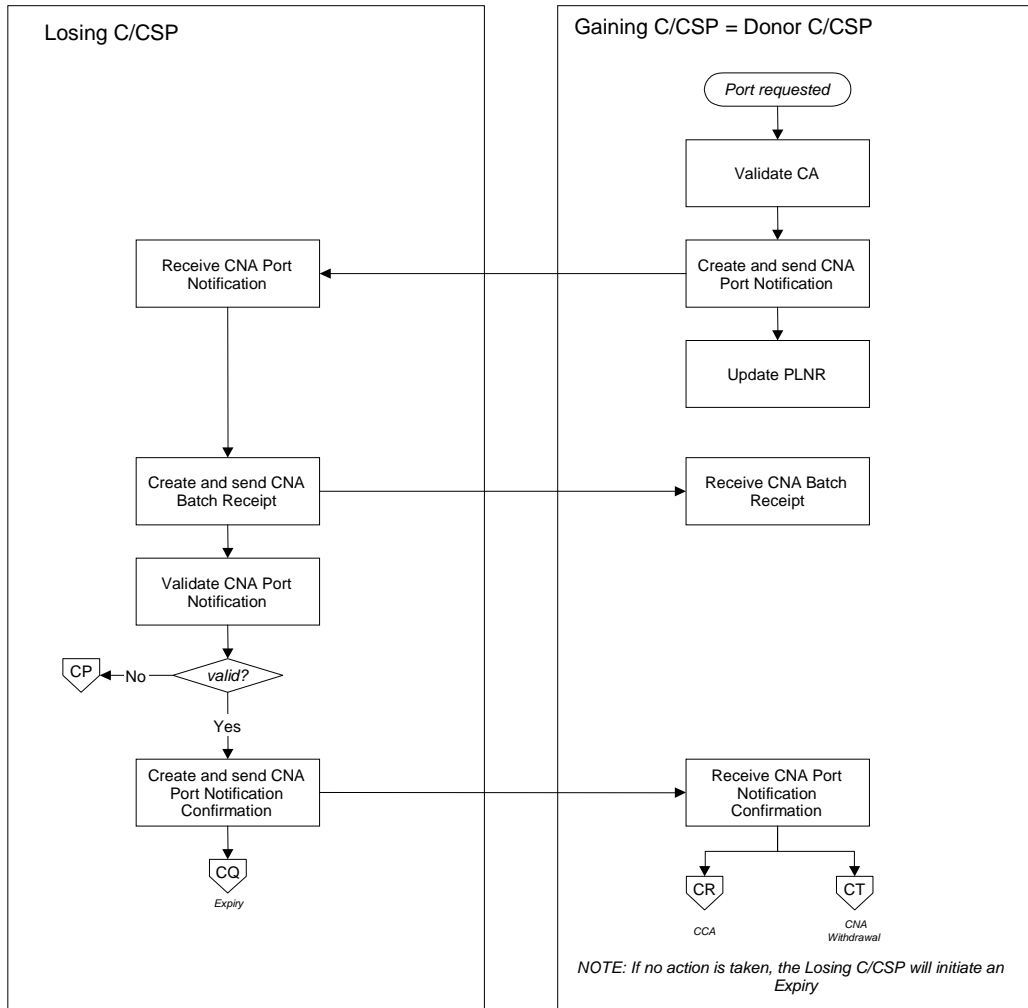

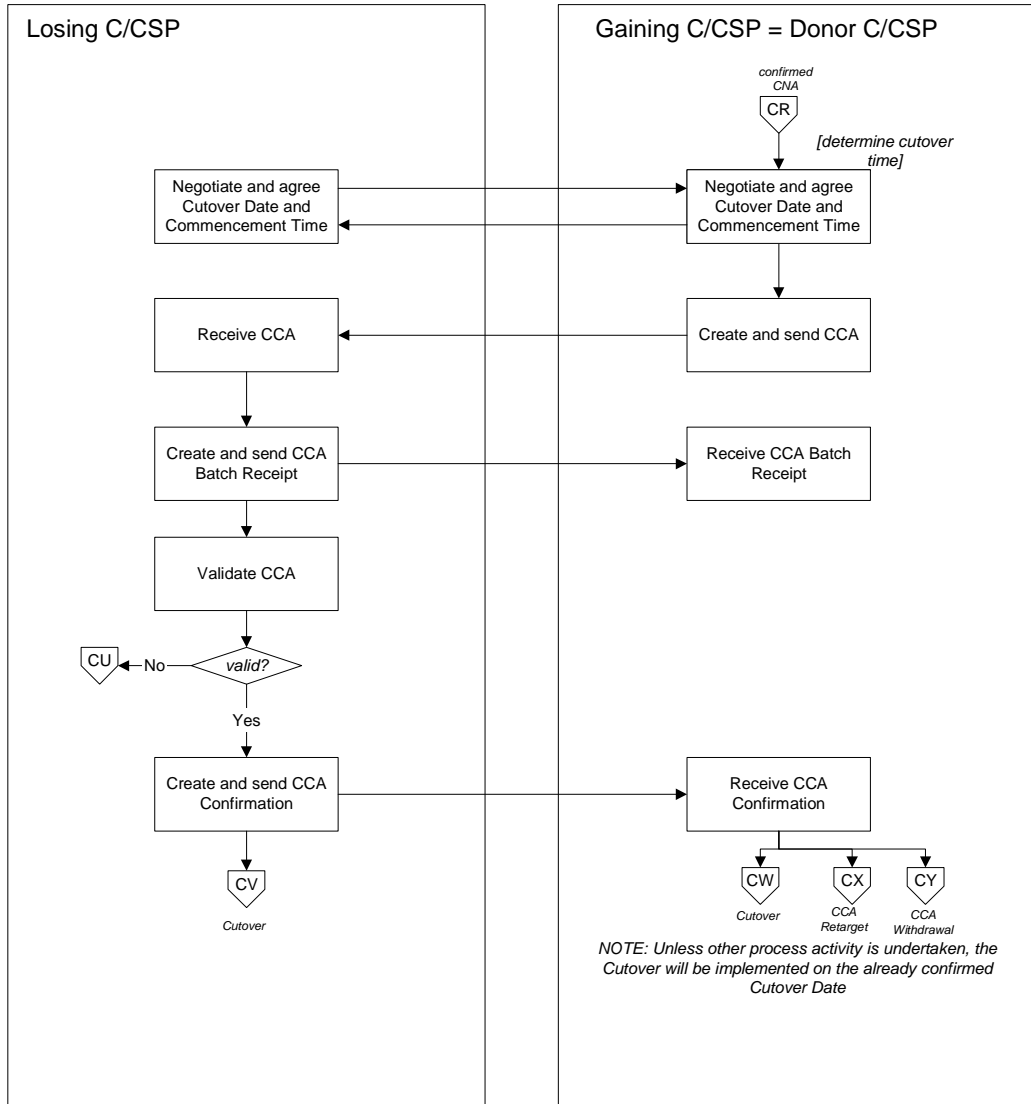

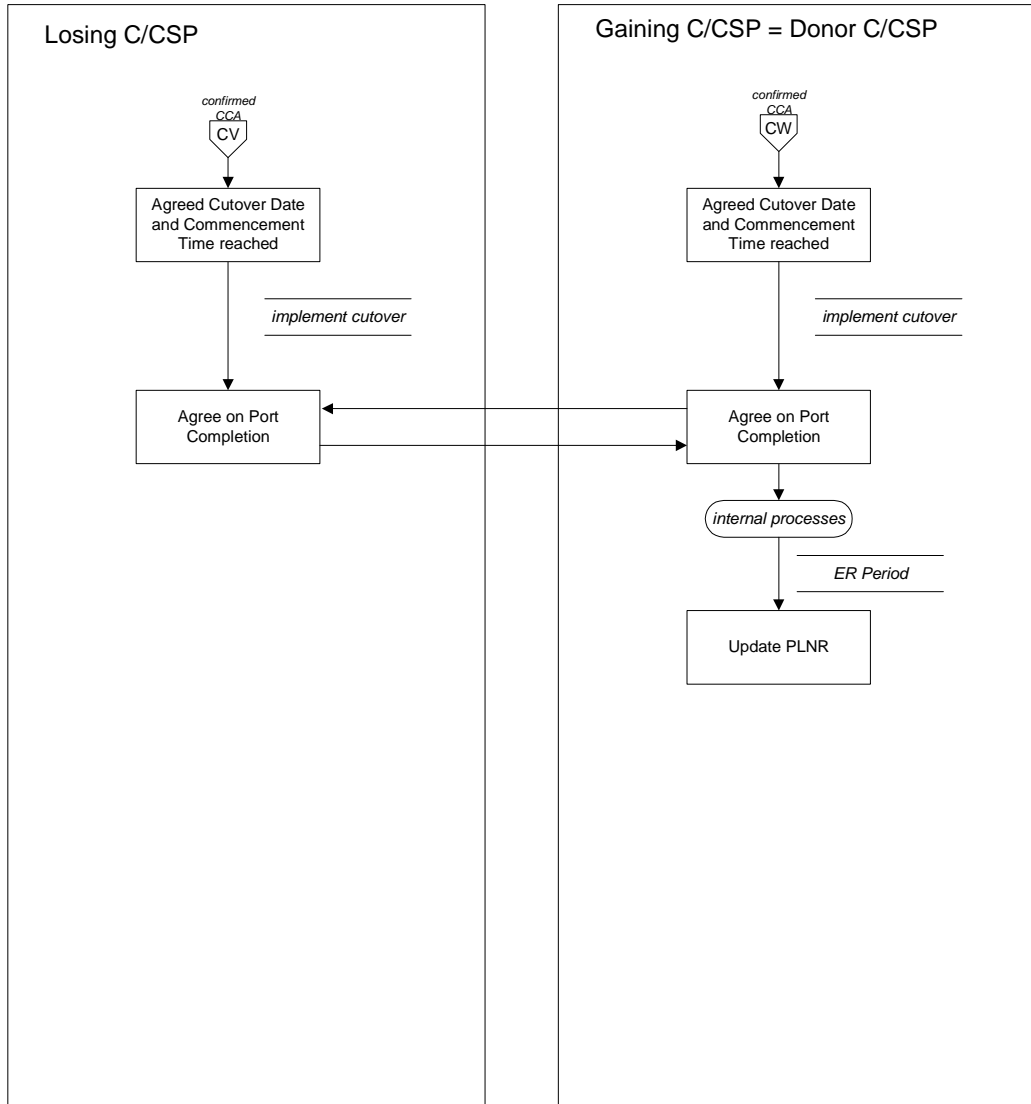

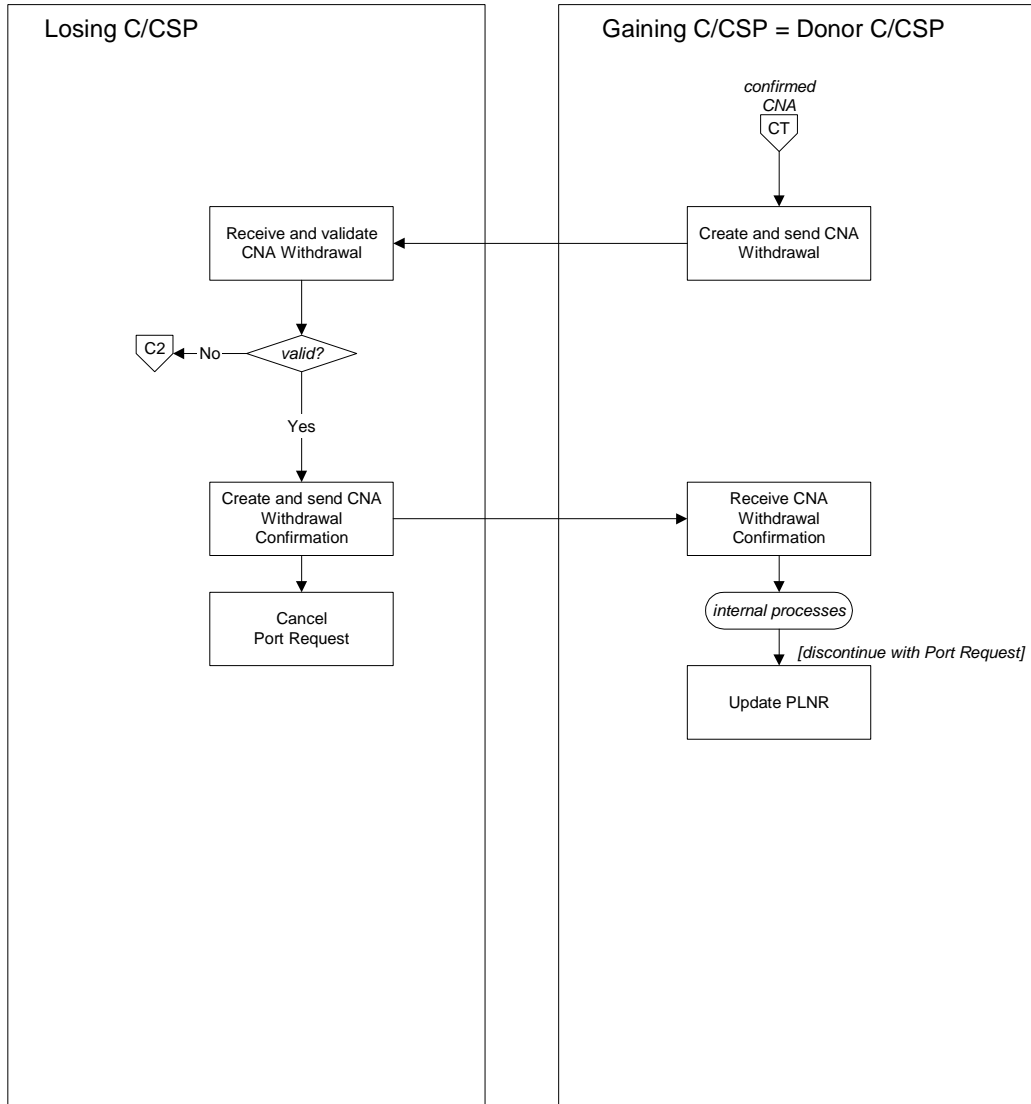

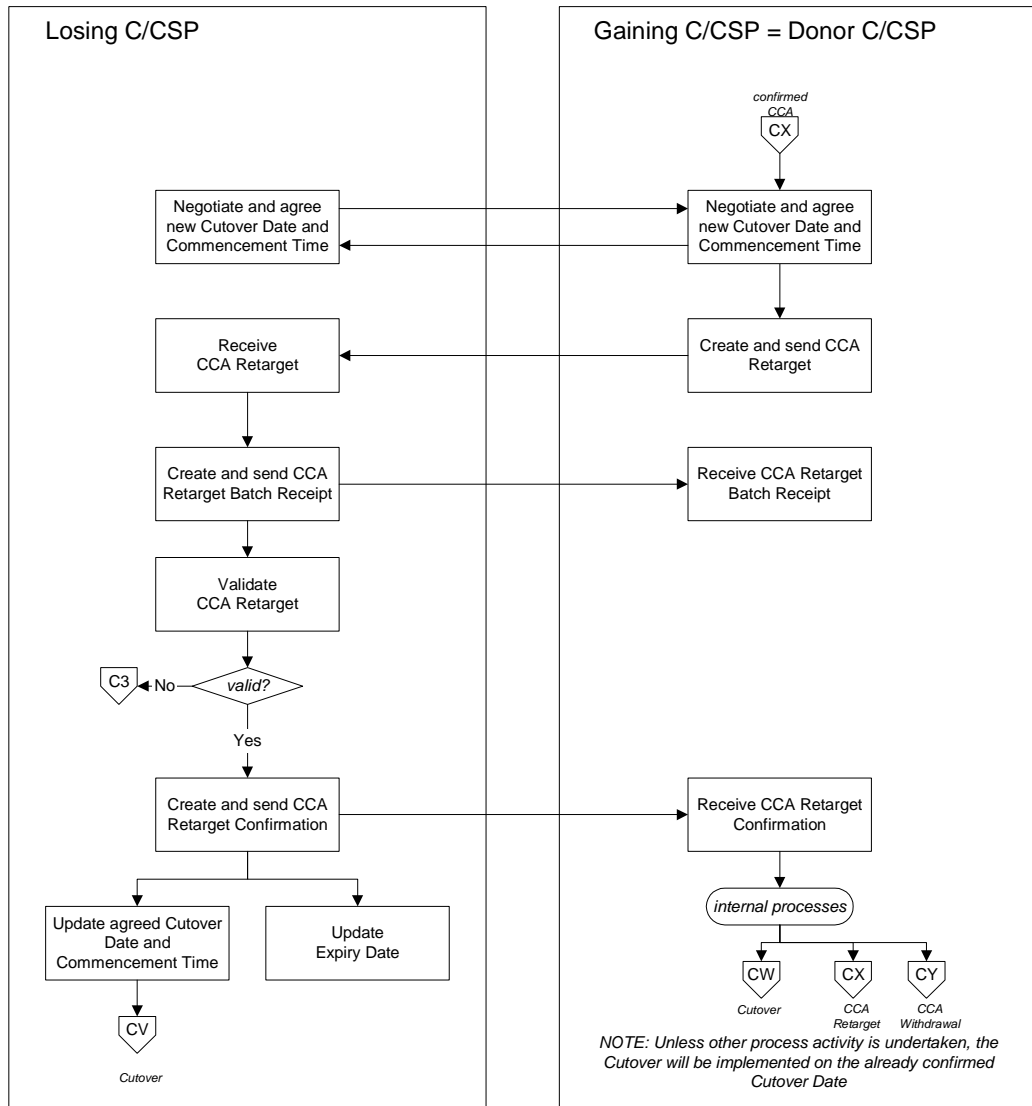

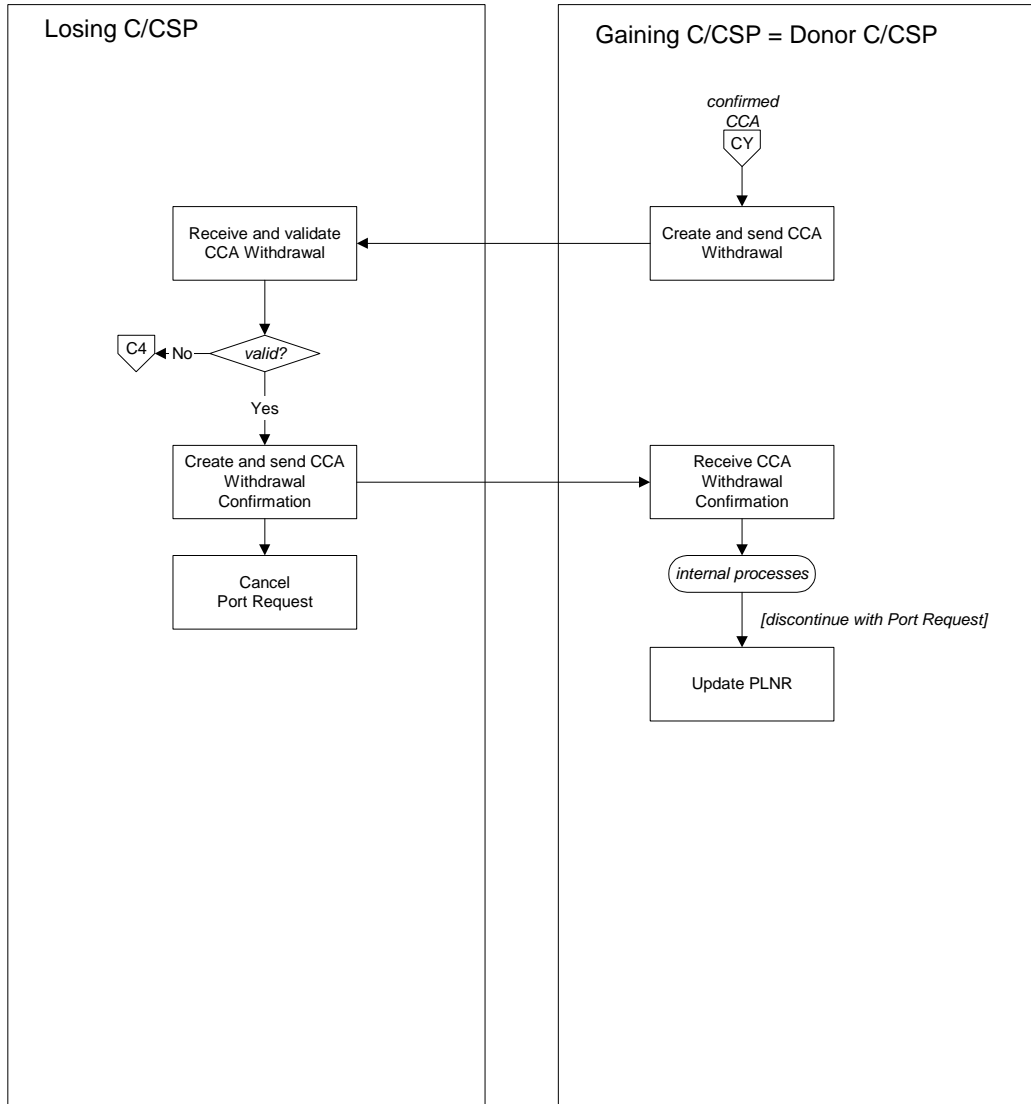

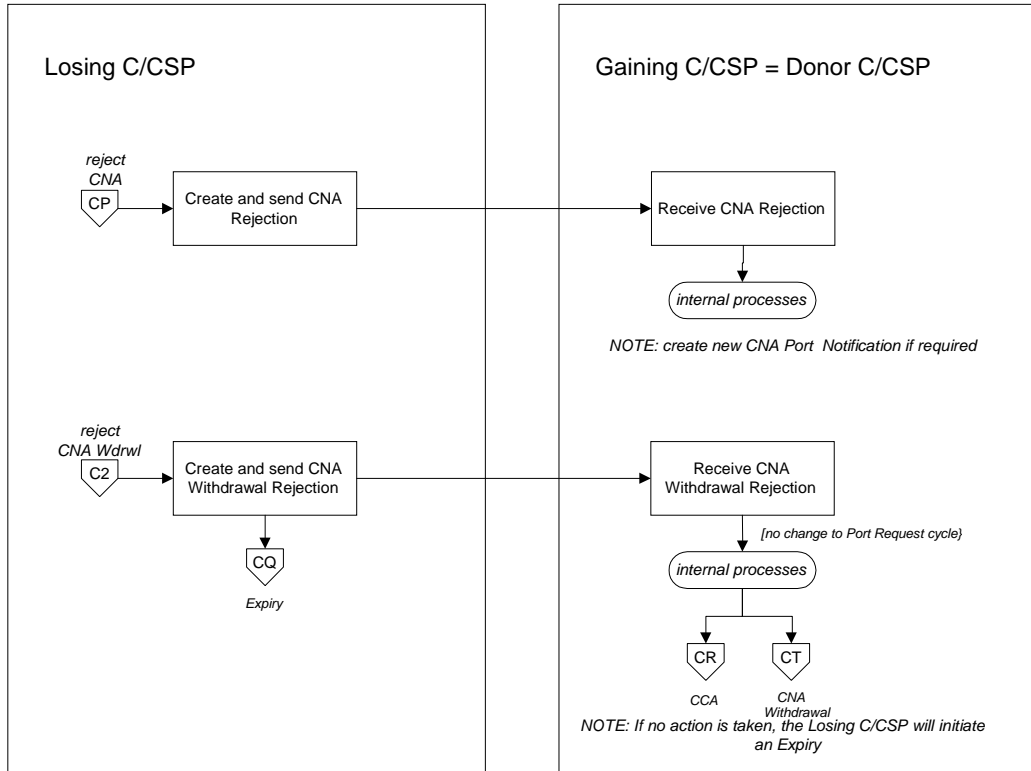

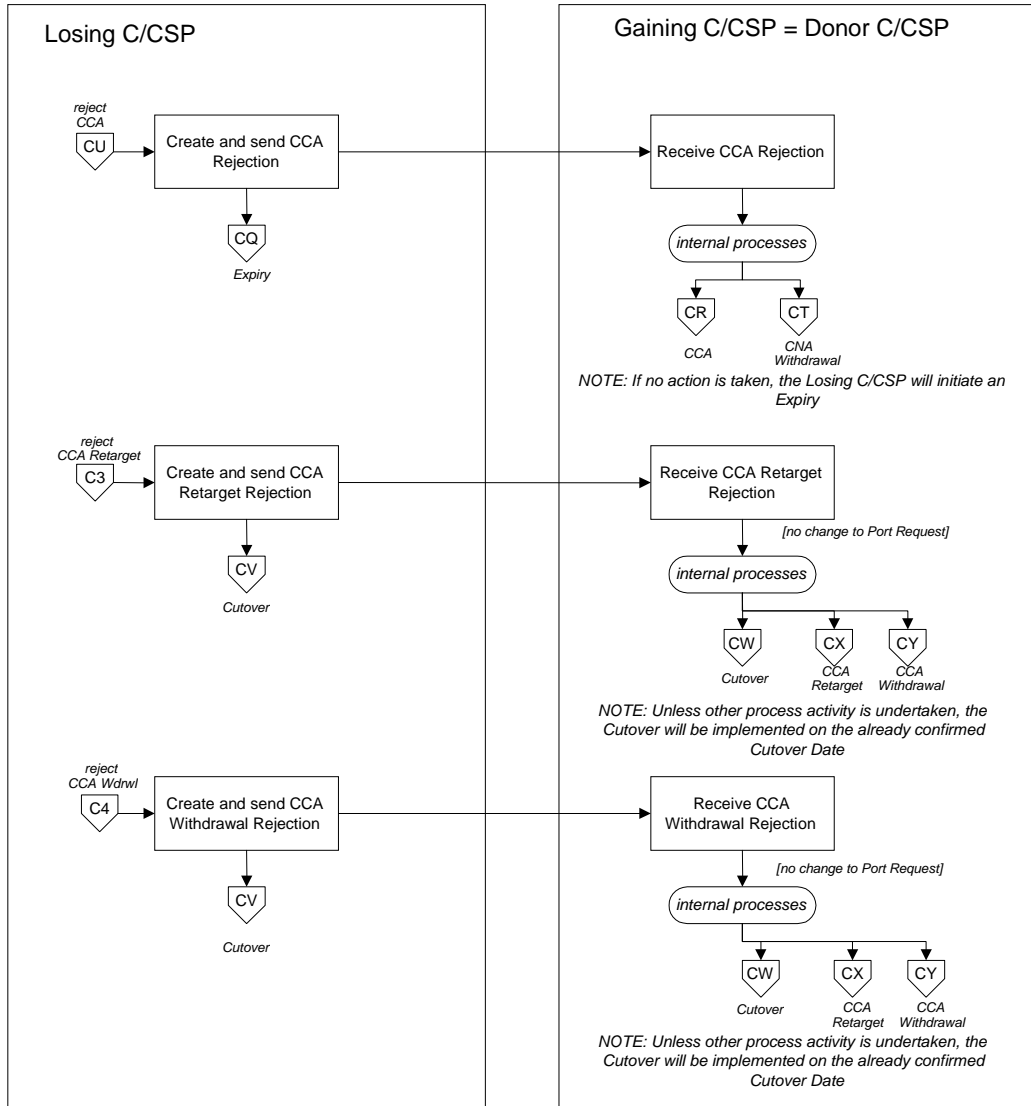

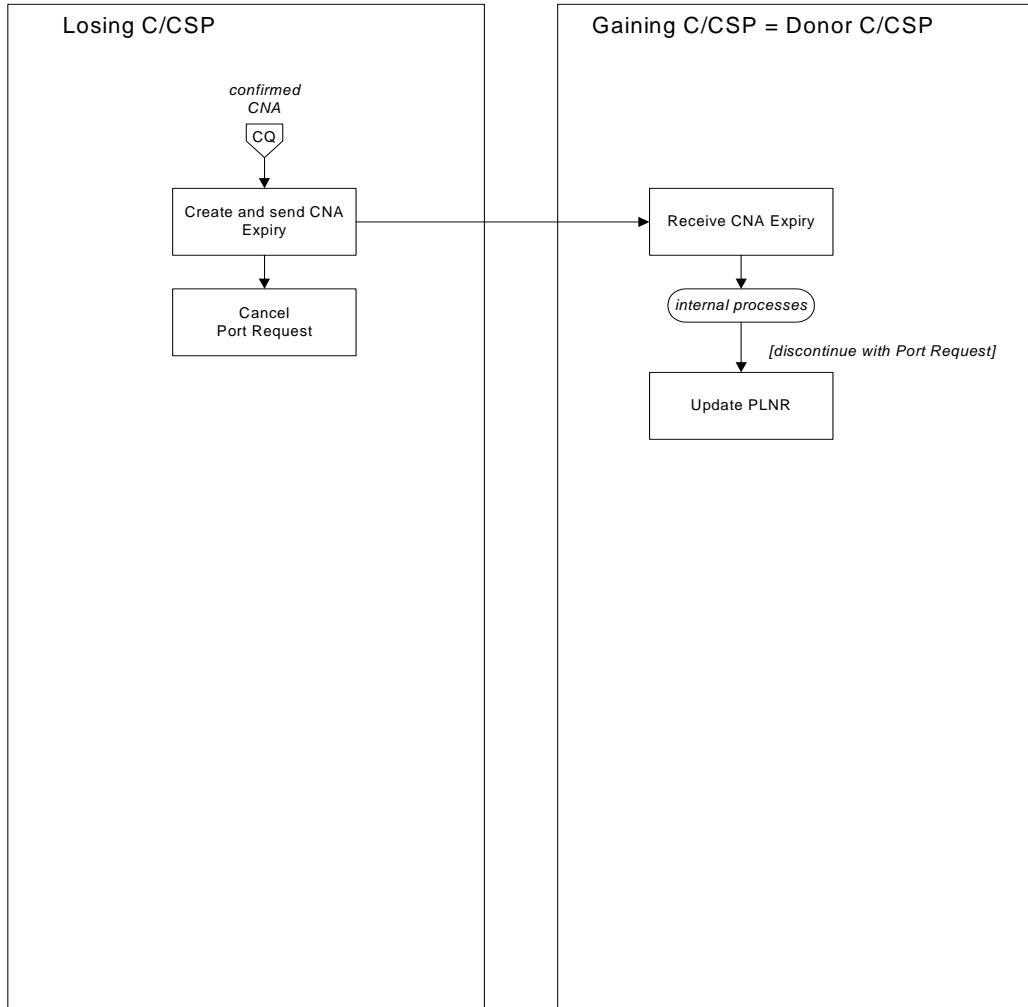

4.3 Cat. C – Third Party

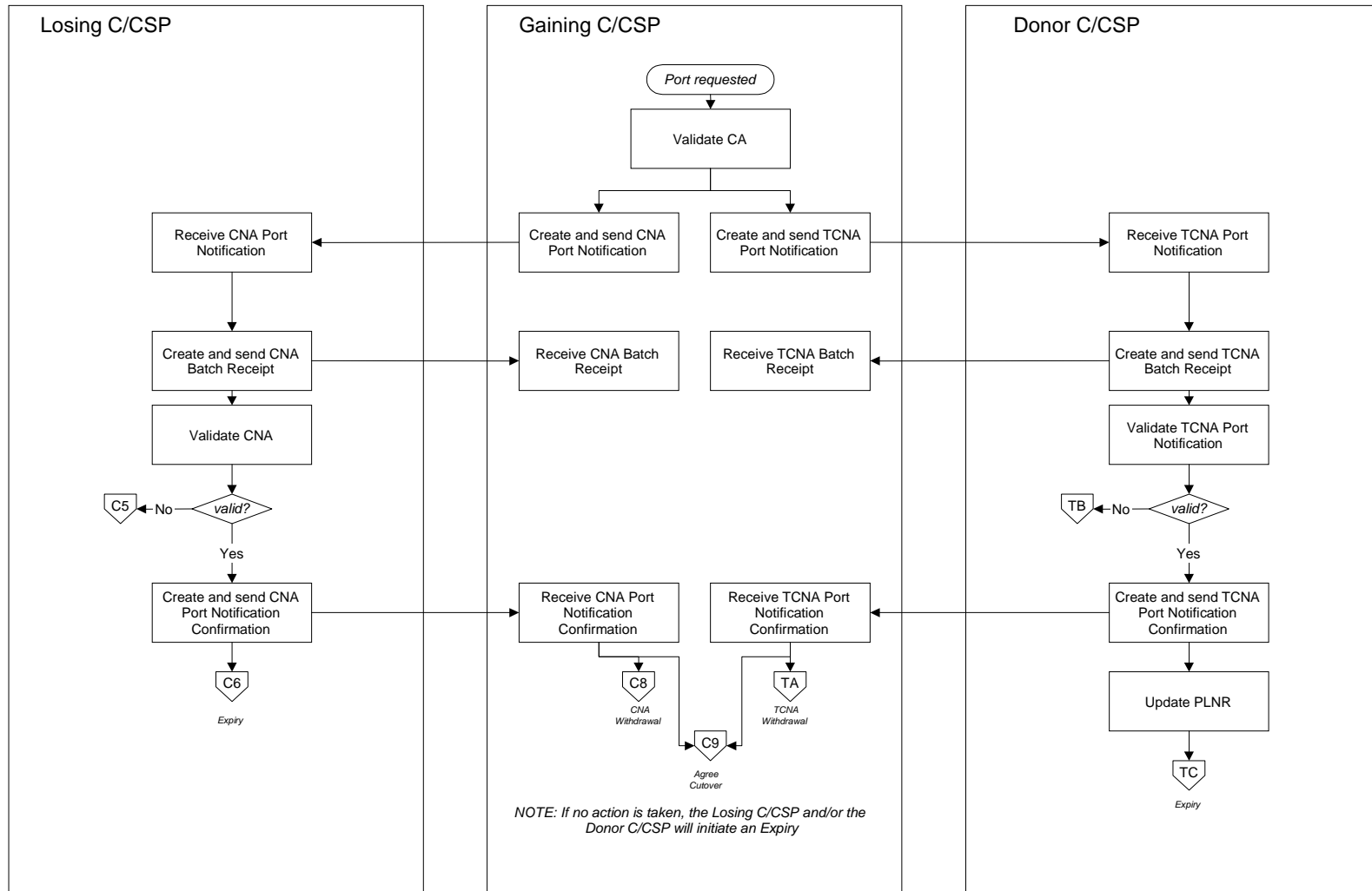

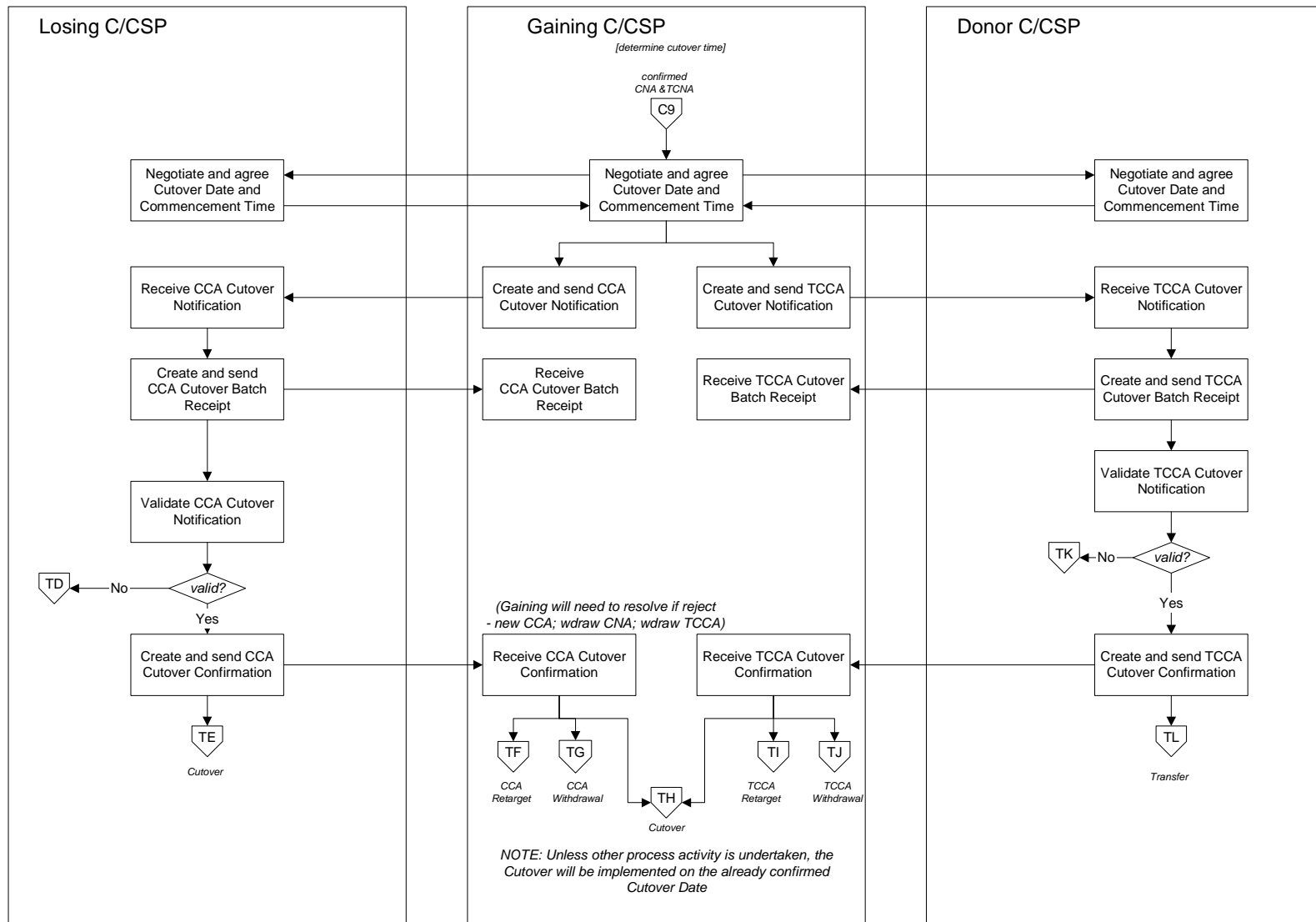

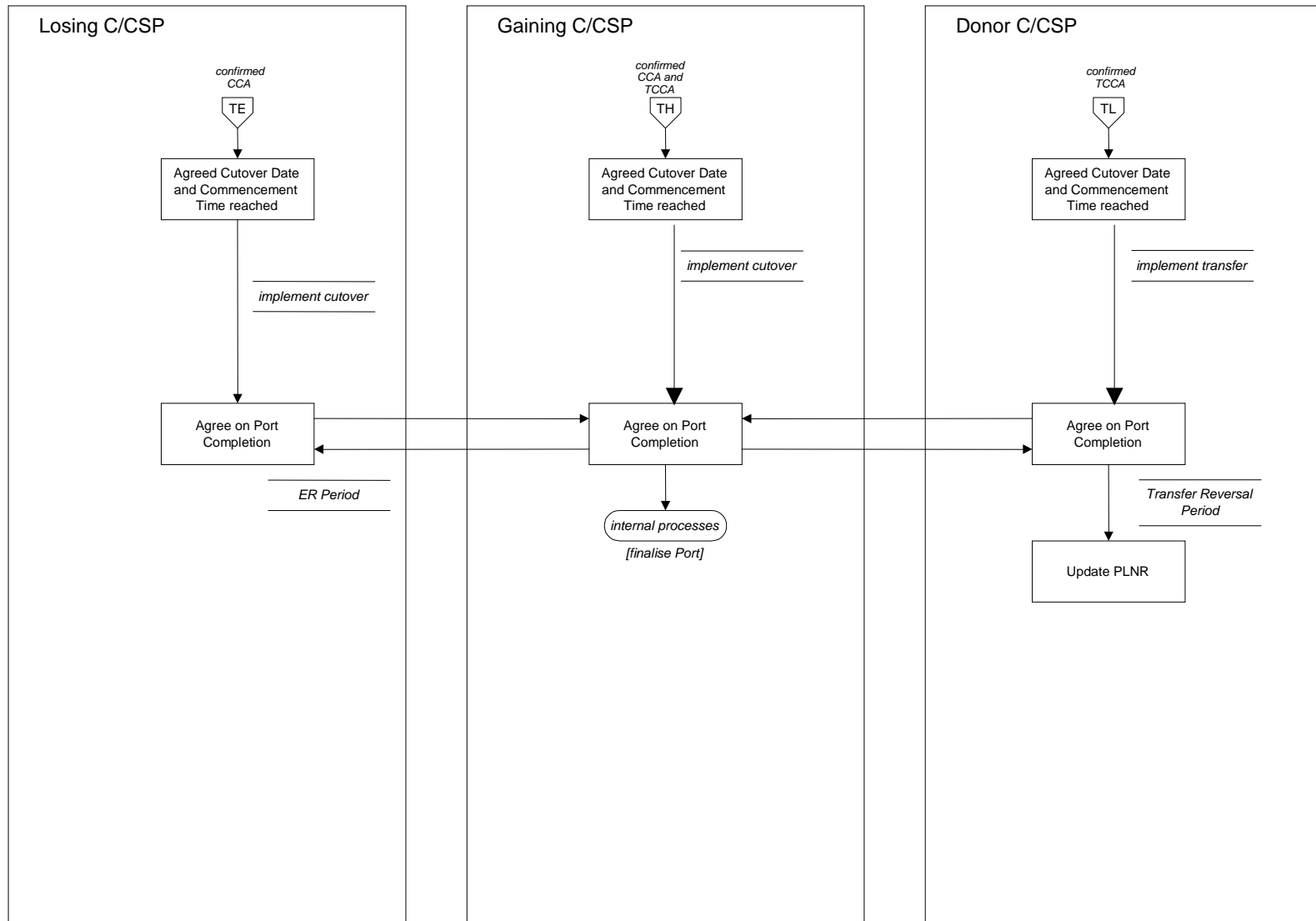

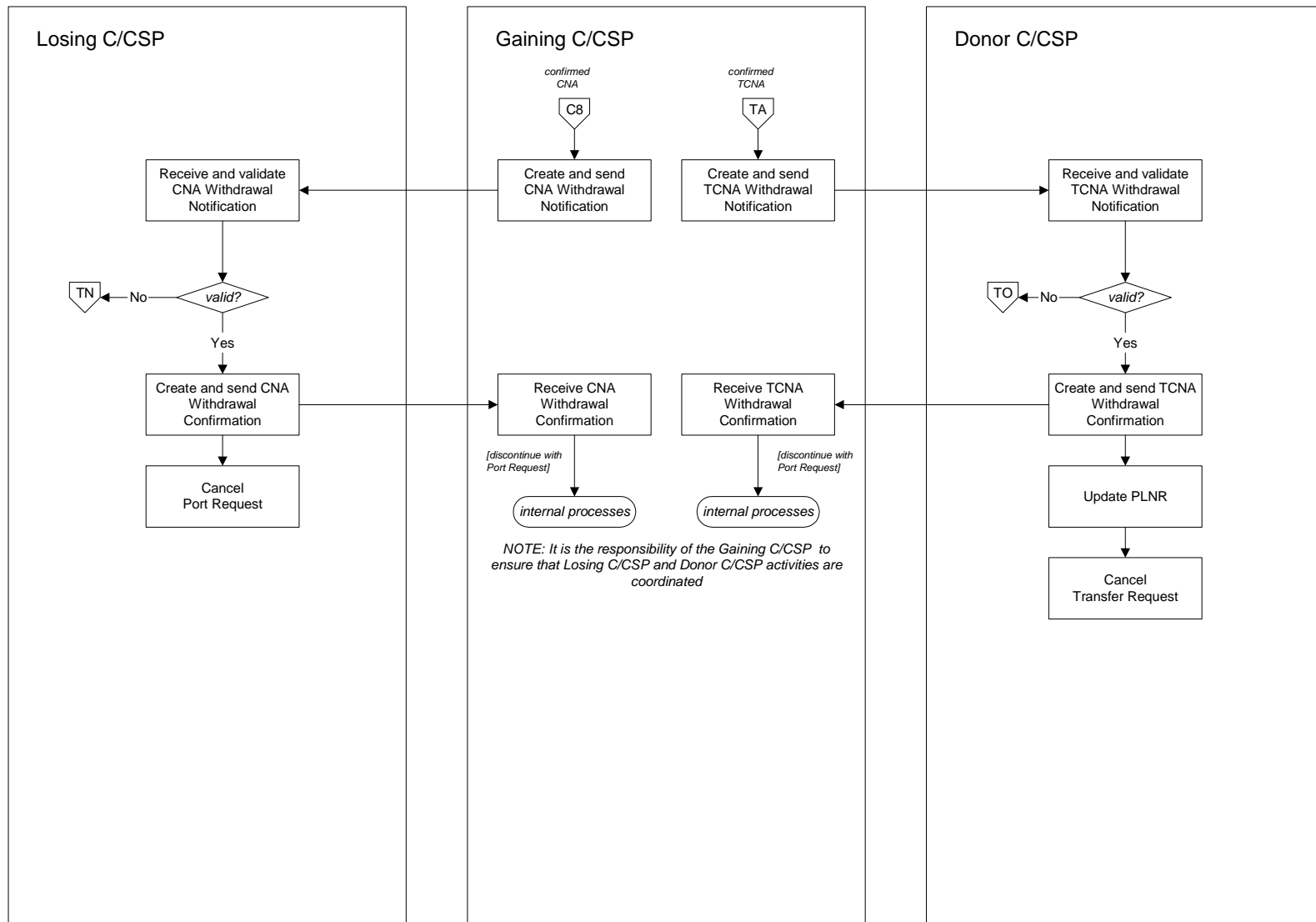

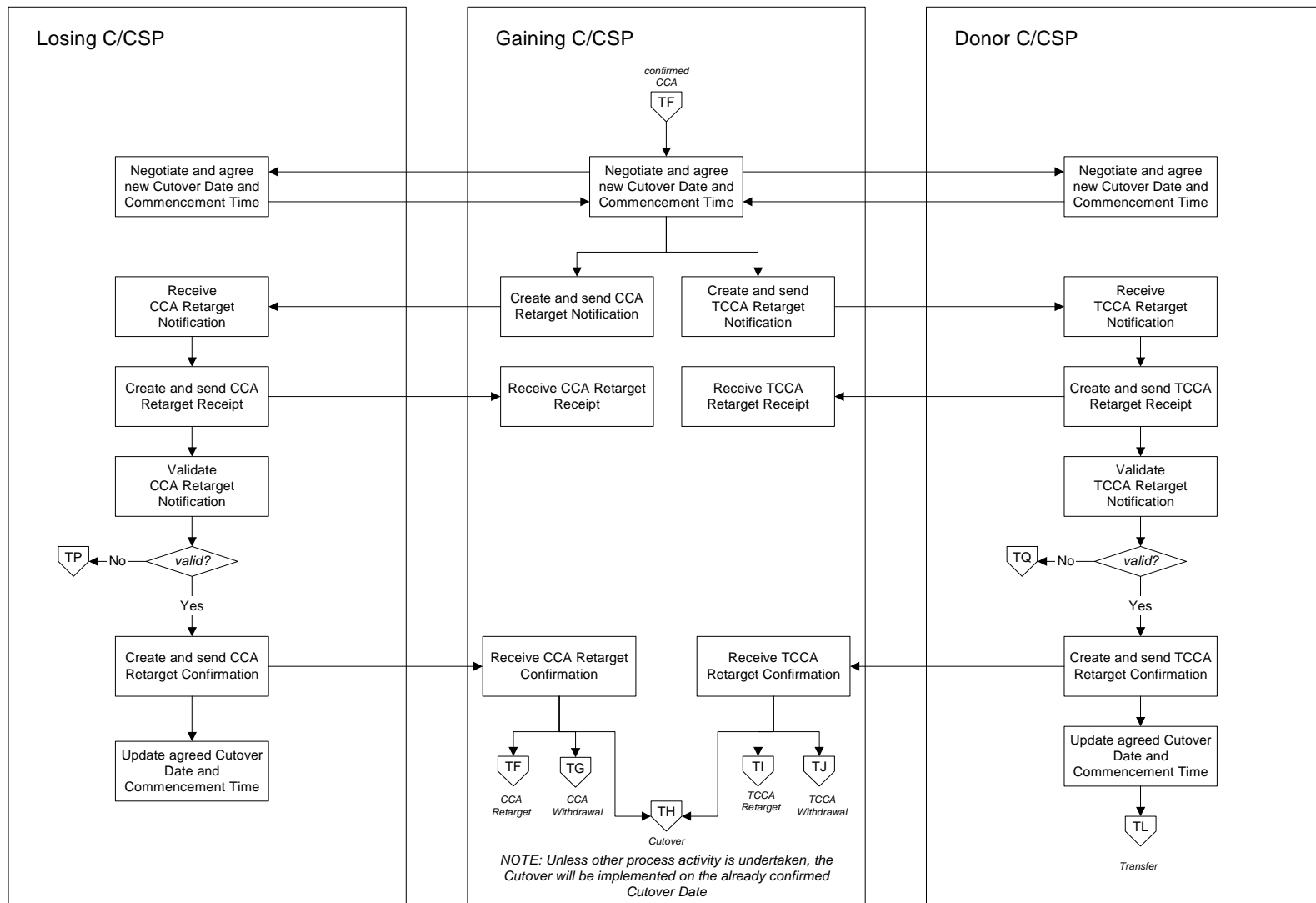

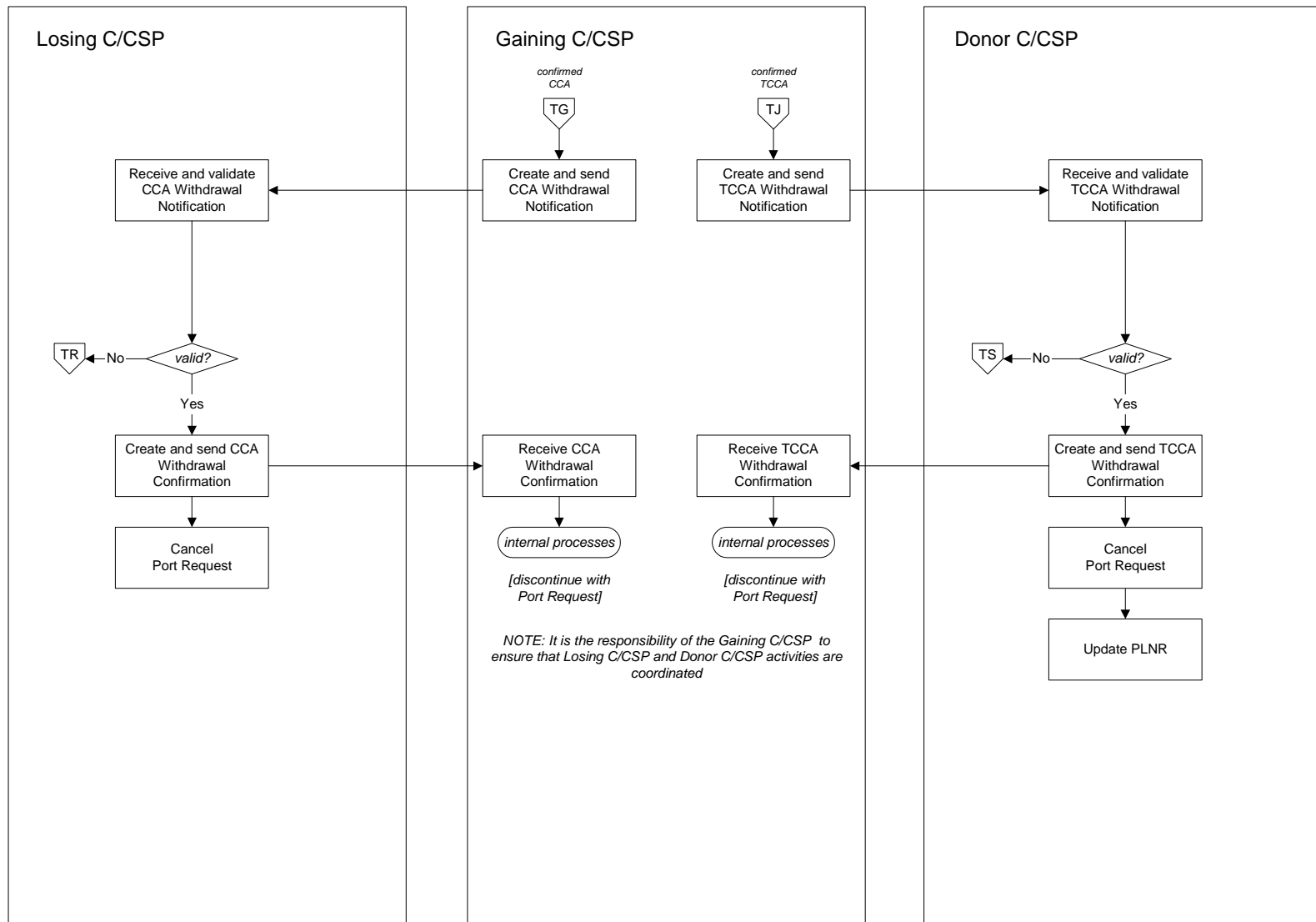

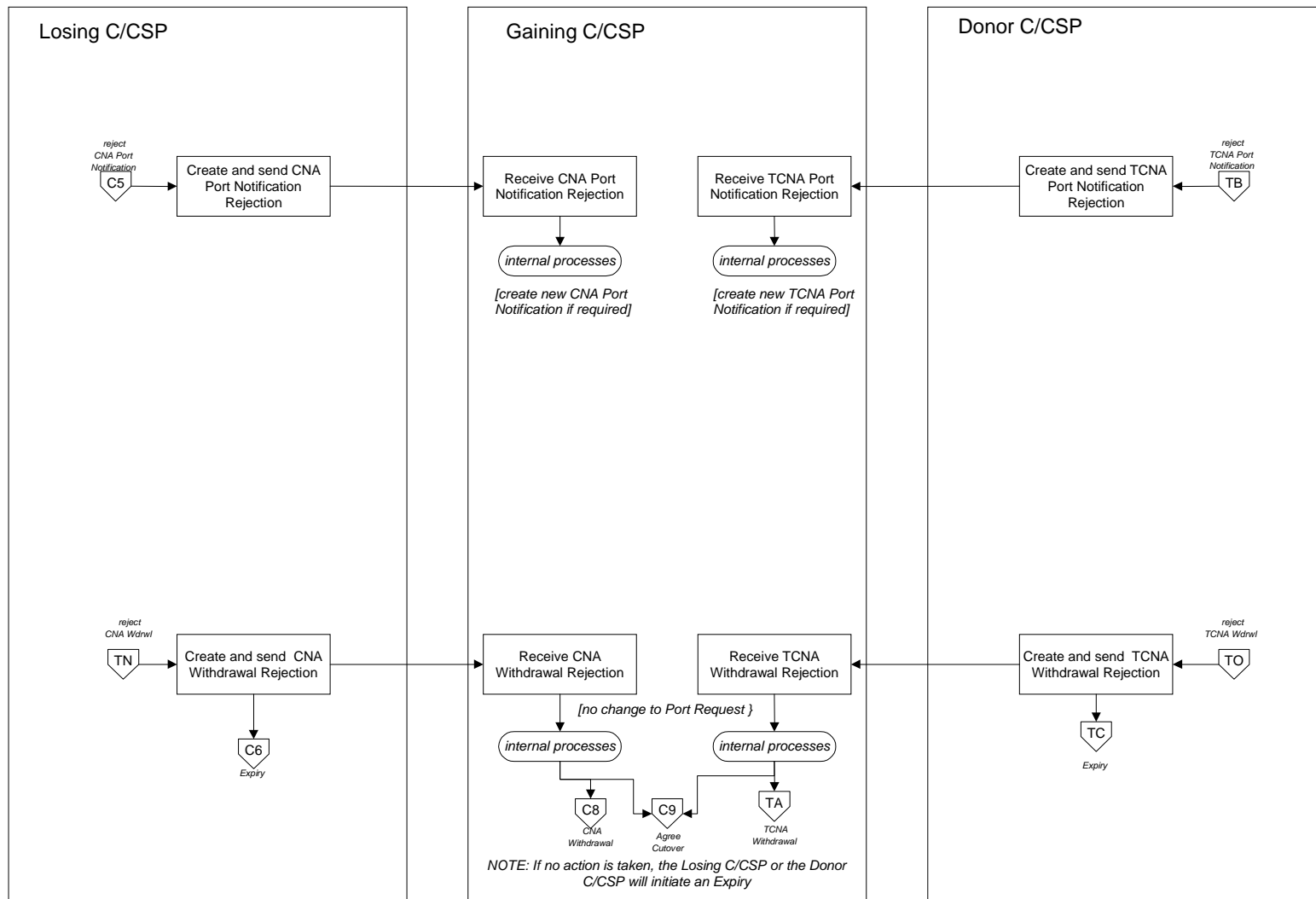

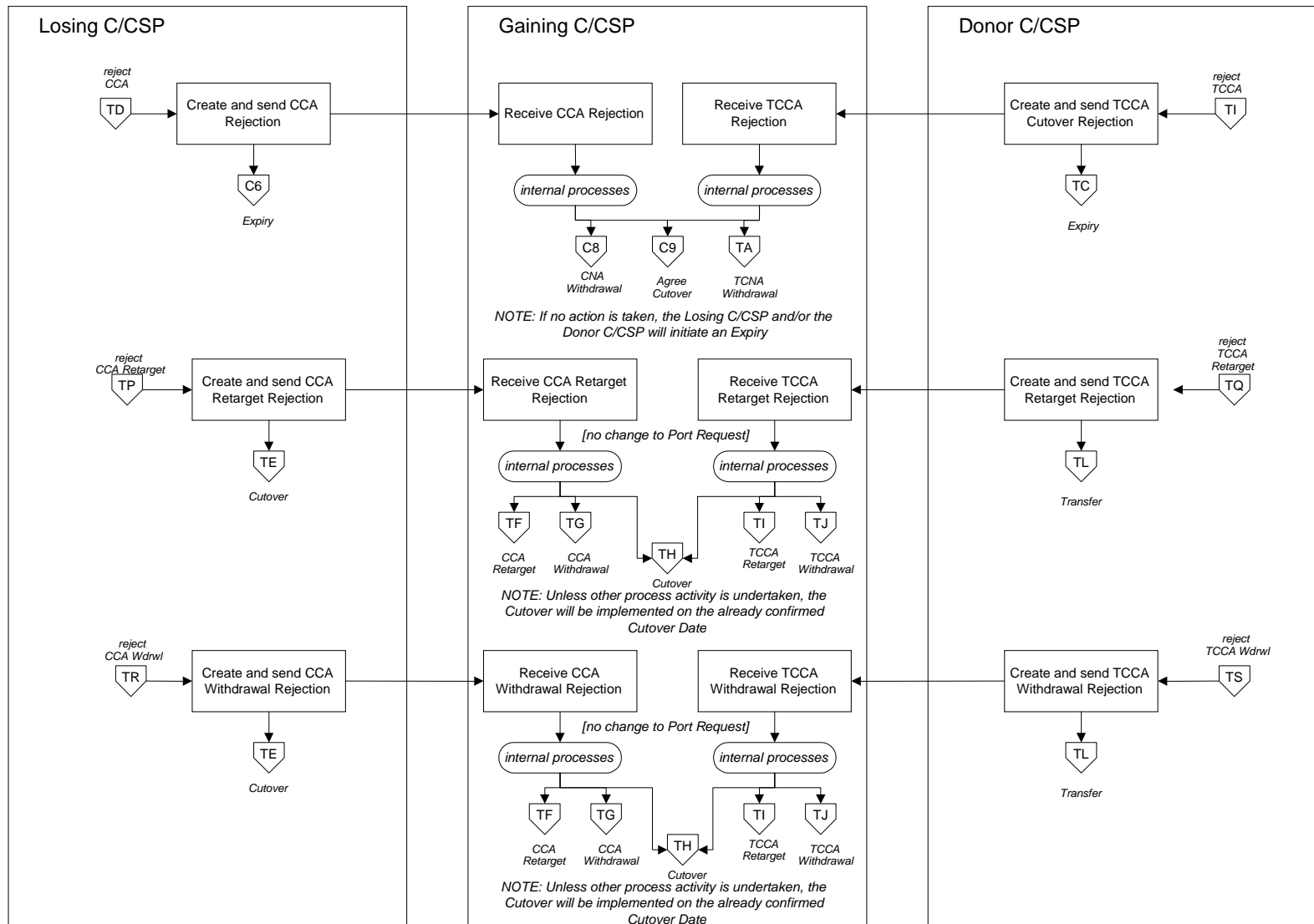

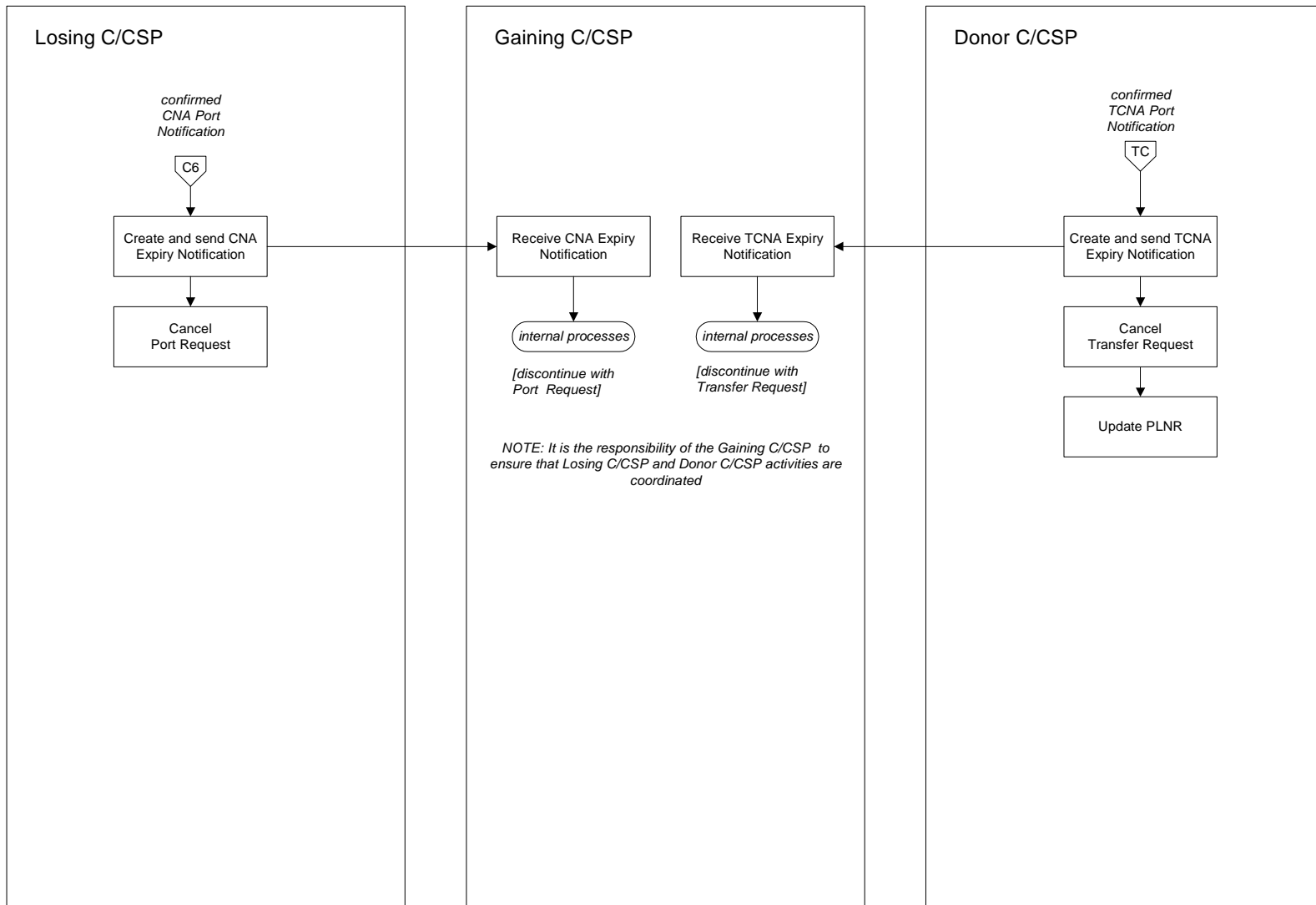

5 CAT. C – PROCESS EVENTS AND VALIDATIONS

5.1 Cat. C - Donor as Losing C/CSP

TWO PARTY CAT. C – Donor as Losing C/CSP					
Legend for C/CSP: G is for Gaining C/CSP L is for Losing C/CSP D is for Donor C/CSP			Legend for File: D is for Daily PNO H is for Hot Batch		
REF	Event	C/CSP	File	Description	Rules
1	Create and send a CNA Port Notification	G	D	Utilised to notify the Losing C/CSP of a Telephone Number being Ported to another C/CSP.	
	Outcomes and Actions			CNA included in daily PNO file for forwarding to Losing C/CSP	
2	Receive CNA Port Notification and send CNA Batch Receipt	L	D	Utilised to notify the Gaining C/CSP that the CNA Port Notification has been received.	Losing C/CSP must send a CNA Batch Receipt within one Business Day of receipt of the CNA Port Notification.
	Outcomes and Actions			The CNA Batch Receipt must be provided to the Gaining C/CSP at the Batch level.	
3	Receive CNA Batch Receipt	G	D		
	Outcomes and Actions				
4	Validate CNA Port Notification	L	D		Losing C/CSP shall validate and reject if: (a) incorrect record format (response code of 020) (b) the Telephone Number is a duplicate in the batch (response code of 040) (c) a Telephone Number or Telephone Numbers could not be found for a batch (response code of 001) (d) Telephone Numbers in the Batch are already Ported to the Gaining C/CSP (response code of 009) (e) Telephone Number in the batch are already Ported to another C/CSP (response code of 010) (f) for a batch a Telephone Number or Telephone Numbers is owned and utilised by the Losing

TWO PARTY CAT. C – Donor as Losing C/CSP					
Legend for C/CSP: G is for Gaining C/CSP L is for Losing C/CSP D is for Donor C/CSP			Legend for File: D is for Daily PNO H is for Hot Batch		
REF	Event	C/CSP	File	Description	Rules
					<p>C/CSP ie. test service (response code of 011)</p> <p>(g) Telephone Numbers in the batch are not active or reserved (response code of 003)</p> <p>(h) Telephone Number in the batch are not associated to the appropriate exchange technology that supports Portability (response code of 015)</p> <p>(i) Telephone Numbers and account numbers in the batch provided are not in a valid association (response code of 017)</p> <p>(j) the product associated to the Telephone Number requires Porting using the Cat. D process (response code of 063)</p> <p>(k) Telephone Numbers in the batch are in the process of being Ported (response code of 008)</p> <p>(l) Telephone Numbers in the batch are pending disconnection (response code of 004)</p> <p>(m) the CA date is more than 90 calendar days from receipt of the CNA Port Notification (response code of 067)</p> <p>(n) the Batch Reference Number is already associated to another active Batch for the Gaining C/CSP (response code of 077)</p> <p>(o) Telephone Numbers in the batch are not inclusive of all Telephone Numbers associated to the Cat C product eg. Losing C/CSP product must have all Telephone Numbers identified in the CNA Port Notification refer to appendix C for examples (response code of 060)</p> <p>(p) the Telephone Numbers</p>

TWO PARTY CAT. C – Donor as Losing C/CSP					
Legend for C/CSP: G is for Gaining C/CSP L is for Losing C/CSP D is for Donor C/CSP			Legend for File: D is for Daily PNO H is for Hot Batch		
REF	Event	C/CSP	File	Description	Rules
					for a product are not contiguous in the batch (response code of 065) (q) the Telephone Numbers are not for a single site or location (response code of 041) (r) the project manager details are not present (response code of 018) (s) the customer contact details are not present (response code of 018) (t) the batch number is not present (response code of 061) (u) the batch is unable to be ported due to excluded product (response code of 073) (v) the Telephone Number is valid but there is another Telephone Number that is rejected due to another primary error in the batch (response code of 064) (w) all mandatory fields are not populated (response code of 018) (x) network based diversion (eg. network service only). (response code of 002)
	Outcomes and Actions				
5	Send CNA Port Notification Confirmation/Rejection	L	D	Utilised to notify the confirmation or rejection of a CNA Port Notification made by the Gaining C/CSP. The rejection advice will show valid and invalid Telephone Numbers and an invalid Telephone Number will have an associated Response code	Losing C/CSP must send an CNA Port Notification Confirmation/Rejection within five Business Days of receipt of the CNA Port Notification
	Outcomes and Actions			Confirmation Confirmation Advice is at the Batch level. Confirmation of the	

TWO PARTY CAT. C – Donor as Losing C/CSP					
Legend for C/CSP: G is for Gaining C/CSP L is for Losing C/CSP D is for Donor C/CSP			Legend for File: D is for Daily PNO H is for Hot Batch		
REF	Event	C/CSP	File	Description	Rules
				<p>CNA Port Notification will commence the expiry count down and the CNA will become active.</p> <p>The expiry date for a confirmed CNA Port Notification will be set 120 days from receipt of the notification (inclusive)</p> <p>Rejection Rejection Advice is at the Telephone Number level. Rejection of the CNA Port Notification will not make the CNA active</p>	
6	Receive CNA Port Notification Confirmation/Rejection	G	D		
	Outcomes and Actions			<p>Confirmation Confirmation of the CNA Port Notification will make the Port active.</p> <p>The expiry date for a confirmed CNA Port Notification will be set 120 days from receipt of the notification (inclusive).</p> <p>The Cutover should be completed within 120 calendar days of the CNA.</p> <p>Rejection Internal operational process</p>	
7	Negotiate Cutover	L & G			The project managers for the Gaining C/CSP and Losing C/CSP will negotiate and agree on a Cutover Date and Commencement Time for the Port.
	Outcomes and Actions				
8	Create and send a CCA Cutover Notification	G	D	Utilised to notify the Losing C/CSP of the agreed Cutover Date	

TWO PARTY CAT. C – Donor as Losing C/CSP					
Legend for C/CSP: G is for Gaining C/CSP L is for Losing C/CSP D is for Donor C/CSP			Legend for File: D is for Daily PNO H is for Hot Batch		
REF	Event	C/CSP	File	Description	Rules
				and Commencement Time for the Batch.	
	Outcomes and Actions			CCA included in daily PNO file for forwarding to Losing C/CSP and is at batch level.	
9	Receive CCA Cutover Notification and send CCA Cutover Batch Receipt	L	D	Utilised to notify the Gaining C/CSP that the CCA Cutover Notification has been received.	Losing C/CSP must send a CCA Cutover Batch Receipt within one Business Day of receipt of the CCA Cutover Notification.
	Outcomes and Actions			The CCA Cutover Batch Receipt must be provided to the Gaining C/CSP at the batch level.	
10	Receive CCA Cutover Batch Receipt	G	D		
	Outcomes and Actions				
11	Validate CCA Cutover Notification	L	D		Losing C/CSP shall validate and reject if: (a) incorrect record format (response code of 020) (b) a confirmed and active CNA Port Notification does not exist for the batch reference number for the same Gaining C/CSP (response code of 035) (c) CCA Cutover Date and Commencement Time are not within standard hours of operations, or as otherwise agreed (response code of 034) (d) The CCA Cutover Date is not within the lifetime of the Port (120 calendar days from the CNA receipt date) (response code of 054) (e) the Cutover Date and Commencement Time are not as agreed (response code of 034) (f) all mandatory fields are not populated (response code of 018)

TWO PARTY CAT. C – Donor as Losing C/CSP					
Legend for C/CSP: G is for Gaining C/CSP L is for Losing C/CSP D is for Donor C/CSP			Legend for File: D is for Daily PNO H is for Hot Batch		
REF	Event	C/CSP	File	Description	Rules
	Outcomes and Actions				
12	Send CCA Cutover Notification Confirmation/Rejection	L	D	Utilised to notify the confirmation or rejection of a CCA Cutover Notification made by the Gaining C/CSP. The invalid batch will be associated with a Response code.	Losing C/CSP must send an CCA Cutover Notification Confirmation/Rejection within three Business Days of receipt of the CCA Cutover Notification
	Outcomes and Actions			Confirmation Confirmation Advice is at the Batch level. Rejection Rejection Advice is at the Batch level. Rejection of the CCA Cutover Notification will leave the CNA active	
13	Receive CCA Cutover Confirmation/Rejection	G	D		
	Outcomes and Actions			Confirmation Only CCA transaction types should be sent after CCA Confirmation is received. Rejection Leaves CNA status unchanged. Internal operational process	
14	Implement Cutover	G	N/A	Cutover is project managed.	
	Outcomes and Actions				
15	Implement Cutover	L	N/A	Cutover is project managed.	
	Outcomes and Actions			Cutover completed and all traffic for the Ported Telephone Numbers are directed to the Gaining C/CSP's network.	
16	Agree Completion of	G & L	N/A	Agreement reached with Losing C/CSP's	

TWO PARTY CAT. C – Donor as Losing C/CSP					
Legend for C/CSP: G is for Gaining C/CSP L is for Losing C/CSP D is for Donor C/CSP			Legend for File: D is for Daily PNO H is for Hot Batch		
REF	Event	C/CSP	File	Description	Rules
	Port			project manager on Port completion.	
	Outcomes and Actions			Where the Cutover of the Port has already commenced and it is determined that the Port cannot proceed, the Emergency Return process should be used. At the expiry of the Emergency Return period following the agreement of a successful Port completion the Ported Local Number Register is updated.	
17	Update Ported Local Number Register	L/D	N/A	The PLNR is only updated following the end of the Emergency Return Period. If an Emergency Return or Emergency Retarget is called, the PLNR is not updated.	The first update of the PLNR will add a new entry for each Telephone Number in the batch consisting of the Telephone Number, Gaining C/CSP's numeric code and the indicator "A". The next update of the PLNR will remove the indicator "A" from the entry for each Telephone Number.
	Outcomes and Actions			Ported Local Number register updated	
18					
19					
20					
21					
22	Send CNA Withdrawal Notification	G	D	Utilised to notify the Losing C/CSP of a withdrawal of the original CNA Port Notification made by the Gaining C/CSP.	
	Outcomes and Actions				

TWO PARTY CAT. C – Donor as Losing C/CSP					
Legend for C/CSP: G is for Gaining C/CSP L is for Losing C/CSP D is for Donor C/CSP			Legend for File: D is for Daily PNO H is for Hot Batch		
REF	Event	C/CSP	File	Description	Rules
23	Receive and Validate CNA Withdrawal Notification	L	D		Losing C/CSP shall validate and reject if: (a) incorrect record format (response code of 020) (b) a confirmed and active CNA Port Notification does not exist or a confirmed CCA exists for the Telephone Number for the same Gaining C/CSP (response code of 056) (c) a CCA Cutover Notification exists for the batch reference number for the same gaining C/CSP (response code of 055) (d) not all mandatory fields are populated (response code of 018) (e) not received at least one Business Day prior to CNA expiry (response code of 032)
	Outcomes and Actions				
24	Send CNA Withdrawal Confirmation/Rejection	L	D	Utilised to notify confirmation or rejection of a CNA Withdrawal Notification made by the Gaining C/CSP.	Losing C/CSP sends CNA Withdrawal Rejection/ Confirmation within one Business Day of receipt of the CNA Withdrawal Notification
	Outcomes and Actions			Losing C/CSP sends CNA Withdrawal Rejection/ Confirmation within one Business Day of receipt of the CNA Withdrawal Notification Confirmations will cancel the CNA	
25	Receive Withdrawal Confirmation/Rejection	G	D		
	Outcomes and Actions				

TWO PARTY CAT. C – Donor as Losing C/CSP					
Legend for C/CSP: G is for Gaining C/CSP L is for Losing C/CSP D is for Donor C/CSP			Legend for File: D is for Daily PNO H is for Hot Batch		
REF	Event	C/CSP	File	Description	Rules
26	Send CCA Retarget Notification	G	D	Utilised to notify the Losing C/CSP of a change in the Cutover Date and Commencement Time	
	Outcomes and Actions				
27	Receive and Receipt CCA Retarget Notification	L	D		A batch receipt will be sent to the gaining C/CSP within one Business Day to confirm that the CCA has been received
	Outcomes and Actions				
28	Validate CCA Retarget Notification	L	D		<p>Losing C/CSP shall validate and reject if:</p> <ul style="list-style-type: none"> (a) incorrect record format (response code of 020) (b) a confirmed and active CCA Port Notification does not exist for the batch reference number for the same gaining C/CSP (response code of 057) (c) CCA Retarget date and time are not within standard hours of operations, or as otherwise agreed (response code of 034). (d) CCA Retarget for a batch number exceeds two Retargets(response code of 037). (e) the Cutover Date is not within the lifetime of the Port(response code of 054). (f) the Cutover Date and Commencement Time are not as agreed (response code of 034) (g) all mandatory fields are not populated (response code of 018) (h) CCA Retarget not received within agreed notification period (response code of 032).
	Outcomes and Actions				
29	Send CCA	L	D	Utilised to notify the	Losing C/CSP sends CCA

TWO PARTY CAT. C – Donor as Losing C/CSP					
Legend for C/CSP: G is for Gaining C/CSP L is for Losing C/CSP D is for Donor C/CSP			Legend for File: D is for Daily PNO H is for Hot Batch		
REF	Event	C/CSP	File	Description	Rules
	Retarget Confirmation/Rejection			confirmation or rejection of a CCA Retarget Notification made by the Gaining C/CSP. The invalid batch will be associated with a Response code.	Retarget Rejection/ Confirmation within three Business Day of receipt of the CCA Retarget Notification
	Outcomes and Actions				
30	Receive CCA Retarget Confirmation/Rejection	G	D		
	Outcomes and Actions				
31	Send CCA Withdrawal Notification	G	D	Utilised to notify the Losing C/CSP of a withdrawal of the CCA Port Notification made by the Gaining C/CSP.	
	Outcomes and Actions				
32	Receive and Validate CCA Withdrawal Notification	L	D		Losing C/CSP shall validate and reject if: (a) incorrect record format (response code of 020) (b) a confirmed and active CCA Cutover Notification does not exist for the Telephone Number for the same Gaining C/CSP (response code of 056) (c) not all mandatory fields are populated (response code of 018) (d) not received at least one Business Day prior to CNA expiry (response code of 032)
	Outcomes and Actions				
33	Send CCA Withdrawal Confirmation/Rejection	L	D	Utilised to notify confirmation or rejection of a CCA Withdrawal Notification made by the Gaining C/CSP.	Losing C/CSP sends CNA Withdrawal Rejection/ Confirmation within one Business Day of receipt of the CNA Withdrawal Notification
	Outcomes and Actions			Losing C/CSP sends CCA Withdrawal Rejection/	

TWO PARTY CAT. C – Donor as Losing C/CSP					
Legend for C/CSP: G is for Gaining C/CSP L is for Losing C/CSP D is for Donor C/CSP			Legend for File: D is for Daily PNO H is for Hot Batch		
REF	Event	C/CSP	File	Description	Rules
				Confirmation within one Business Day of receipt of the CNA Withdrawal Notification Confirmations will cancel the CNA	
34	Receive Withdrawal Confirmation/Rejection	G	D		
	Outcomes and Actions				
35	Send CNA Expiry Notification	L	D	Utilised to notify the Gaining C/CSP that the valid period for the CNA Port Notification has expired and hence deemed to be cancelled	Any CNA that exceeds its CNA expiry date will have an CNA Expiry Notification sent to the Gaining C/CSP one Business Day after the expiry date Losing C/CSP cancels the CNA
	Outcomes and Actions			Any CNA that exceeds its CNA expiry date will have an CNA Expiry Notification sent to the Gaining C/CSP one Business Day after the expiry date The CNA is no longer valid.	
36	Receive CNA Expiry Notification	G	D		
	Outcomes and Actions			Internal operational process	

5.2 Cat. C - Donor as Gaining C/CSP

TWO PARTY CAT. C – Donor as Gaining C/CSP					
Legend for C/CSP: G is for Gaining C/CSP L is for Losing C/CSP D is for Donor C/CSP			Legend for File: D is for Daily PNO H is for Hot Batch		
REF	Event	C/CSP Role	File	Description	Rules
1	Create and send a CNA Port Notification	G	D	Utilised to notify the Losing C/CSP of a Telephone Number being Ported to another C/CSP.	
	Outcomes and Actions			CNA included in daily PNO file for forwarding to Losing C/CSP	
2	Update Ported Local Number Register	G/D	N/A		The update of the PLNR will add the indicator "D" to the entry for each Telephone Number in the batch. The next update of the PLNR will replace the indicator "D" with a new indicator of "E" in the entry for each Telephone Number.
	Outcomes and Actions			Ported Local Number Register updated	
3	Receive CNA Port Notification and send CNA Batch Receipt	L	D	Utilised to notify the Gaining C/CSP that the CNA Port Notification has been received.	Losing C/CSP must send a CNA Batch Receipt within one Business Day of receipt of the CNA Port Notification.
	Outcomes and Actions			The CNA Receipt must be provided to the Gaining C/CSP at the Batch level.	
4	Receive CNA Batch Receipt	G	D		
	Outcomes and Actions				
5	Validate CNA Port Notification	L	D		Losing C/CSP shall validate and reject if: (a) incorrect record format (response code of 020) (b) the Telephone Number is a duplicate in the batch (response code of 040) (c) a Telephone Number or Telephone Numbers could not be found for a batch (response code of 001) (d) all Telephone Numbers in the Batch are already Ported to the Gaining

TWO PARTY CAT. C – Donor as Gaining C/CSP					
Legend for C/CSP: G is for Gaining C/CSP L is for Losing C/CSP D is for Donor C/CSP			Legend for File: D is for Daily PNO H is for Hot Batch		
REF	Event	C/CSP Role	File	Description	Rules
					<p>the batch are not inclusive of all services associated to the Cat C product eg. Losing C/CSP product must have all Telephone Numbers identified in the CNA Port Notification refer to appendix C for examples (response code of 060)</p> <p>(p) the Telephone Numbers for a product are not contiguous in the batch (response code of 065)</p> <p>(q) the Telephone Numbers are not for a single site or location (response code of 041)</p> <p>(r) the project manager details are not present (response code of 018)</p> <p>(s) the customer contact details are not present (response code of 018)</p> <p>(t) the batch number is not present (response code of 061)</p> <p>(u) the batch is unable to be Ported due to excluded product (response code of 073)</p> <p>(v) the Telephone Number is valid but there is another Telephone Number that is rejected due to another primary error in the batch (response code of 064)</p> <p>(w) network based diversion (eg. network service only). (response code of 002)</p>
	Outcomes and Actions				

TWO PARTY CAT. C – Donor as Gaining C/CSP					
Legend for C/CSP: G is for Gaining C/CSP L is for Losing C/CSP D is for Donor C/CSP			Legend for File: D is for Daily PNO H is for Hot Batch		
REF	Event	C/CSP Role	File	Description	Rules
6	Send CNA Port Notification Confirmation/Rejection	L	D	Utilised to notify the confirmation or rejection of a CNA Port Notification made by the Gaining C/CSP. The rejection advice will show valid and invalid Telephone Numbers and an invalid Telephone Number will have an associated response code	Losing C/CSP must send an CNA Port Notification Confirmation/Rejection within five Business Days of receipt of the CNA Port Notification
	Outcomes and Actions			<p>Confirmation Confirmation Advice is at the Batch level. Confirmation of the CNA Port Notification will commence the expiry count down and the CNA will become active. The expiry date for a confirmed CNA Port Notification will be set 120 days from receipt of the notification (inclusive)</p> <p>Rejection Rejection Advice is at the Telephone Number level. Rejection of the CNA Port Notification will not make the CNA active</p>	
7	Receive CNA Confirmation/Rejection	G	D		
	Outcomes and Actions			<p>Confirmation Confirmation of the CNA Port Notification will make the Port active. The expiry date for a confirmed CNA Port Notification will be set 120 days from receipt of the notification (inclusive). The Cutover should be completed within 120 calendar days of the CNA.</p> <p>Rejection Internal operational process</p>	

TWO PARTY CAT. C – Donor as Gaining C/CSP					
Legend for C/CSP: G is for Gaining C/CSP L is for Losing C/CSP D is for Donor C/CSP			Legend for File: D is for Daily PNO H is for Hot Batch		
REF	Event	C/CSP Role	File	Description	Rules
8	Negotiate Cutover	L & G			The project managers for the Gaining C/CSP and Losing C/CSP will negotiate and agree on a Cutover Date and Commencement Time for the Port.
	Outcomes and Actions				
9	Create and send a CCA Cutover Notification	G	D	Utilised to notify the Losing C/CSP of the agreed Cutover Date and Commencement Time for the Batch.	
	Outcomes and Actions			CCA included in daily PNO file for forwarding to Losing C/CSP	
10	Receive CCA Cutover Notification and send CCA Cutover Batch Receipt	L	D	Utilised to notify the Gaining C/CSP that the CCA Cutover Notification has been received.	Losing C/CSP must send a CCA Cutover Batch Receipt within one Business Day of receipt of the CCA Cutover Notification.
	Outcomes and Actions			The CCA Receipt must be provided to the Gaining C/CSP at the batch level.	
11	Receive CCA Cutover Batch Receipt	G	D		
	Outcomes and Actions				
12	Validate CCA Cutover Notification	L	D		Losing C/CSP shall validate and reject if: (a) incorrect record format (response code of 020) (b) a confirmed and active CNA Port Notification does not exist for the batch reference number for the same Gaining C/CSP (response code of 035) (c) CCA Cutover Date and Commencement Time are not within standard hours of operations, or as otherwise agreed (response code of 034) (d) The CCA Cutover Date is not within the lifetime of the Port (120 calendar days from the CNA

TWO PARTY CAT. C – Donor as Gaining C/CSP					
Legend for C/CSP: G is for Gaining C/CSP L is for Losing C/CSP D is for Donor C/CSP			Legend for File: D is for Daily PNO H is for Hot Batch		
REF	Event	C/CSP Role	File	Description	Rules
					receipt date) (response code of 054) (e) the Cutover Date and Commencement Time are not as agreed (response code of 034) (f) all mandatory fields are not populated (response code of 018)
	Outcomes and Actions				
13	Send CCA Cutover Confirmation/Rejection	L	D	Utilised to notify the confirmation or rejection of a CCA Cutover Notification made by the Gaining C/CSP. The invalid batch will be associated with a Response code.	Losing C/CSP must send an CCA Cutover Confirmation/Rejection within three Business Days of receipt of the CCA Cutover Notification
	Outcomes and Actions			Confirmation Confirmation Advice is at the batch level. Rejection Rejection Advice is at the batch level. Rejection of the CCA Cutover Notification will leave the CNA active	
14	Receive CCA Cutover Confirmation/Rejection	G	D		
	Outcomes and Actions			Confirmation Only CCA transaction types should be sent after CCA Confirmation is received. Rejection Leaves CNA status unchanged. Internal operational process	
15	Implement Cutover	G	N/A	Cutover is project managed.	
	Outcomes and Actions				
16	Implement Cutover	L	N/A	Cutover is project managed.	

TWO PARTY CAT. C – Donor as Gaining C/CSP					
Legend for C/CSP: G is for Gaining C/CSP L is for Losing C/CSP D is for Donor C/CSP			Legend for File: D is for Daily PNO H is for Hot Batch		
REF	Event	C/CSP Role	File	Description	Rules
	Outcomes and Actions			Cutover completed and all traffic for the Ported Telephone Numbers are directed to the Gaining C/CSP's network.	
17	Agree Completion of Port	G & L	N/A	Agreement reached with Losing C/CSP's project manager on Port completion.	
	Outcomes and Actions			Where the Cutover of the Port has already commenced and it is determined that the Port cannot proceed, the Emergency Return process should be used. At the expiry of the Emergency Return period following the agreement of a successful Port completion the Ported Local Number Register is updated.	
18	Update Ported Local Number Register	G/D	N/A	The PLNR is only updated following the end of the Emergency Return Period. If an Emergency Return or Emergency Retarget is called, the PLNR is not updated.	The update of the PLNR will replace the existing indicator either "D" or "E" in the entry for each Telephone Number in the batch with a new indicator of "C". The next update of the PLNR will remove the entry for each Telephone Number from the PLNR.
	Outcomes and Actions			Ported Local Number Register updated	
19					
20					
21					
22					
23	Send CNA Withdrawal Notification	G	D	Utilised to notify the Losing C/CSP of a withdrawal of the original CNA Port Notification made by the Gaining	

TWO PARTY CAT. C – Donor as Gaining C/CSP					
Legend for C/CSP: G is for Gaining C/CSP L is for Losing C/CSP D is for Donor C/CSP			Legend for File: D is for Daily PNO H is for Hot Batch		
REF	Event	C/CSP Role	File	Description	Rules
				C/CSP.	
	Outcomes and Actions				
24	Receive and Validate CNA Withdrawal Notification	L	D		Losing C/CSP shall validate and reject if: (a) incorrect record format (response code of 020) (b) a confirmed and active CNA Port Notification does not exist or a confirmed CCA exists for the Telephone Number for the same Gaining C/CSP (response code of 056) (c) a CCA Cutover Notification exists for the batch reference number for the same gaining C/CSP (response code of 055) (d) not all mandatory fields are populated (response code of 018) (e) not received at least one Business Day prior to CNA expiry (response code of 032)
	Outcomes and Actions				
25	Send CNA Withdrawal Confirmation/Rejection	L	D	Utilised to notify confirmation or rejection of a CNA Withdrawal Notification made by the Gaining C/CSP.	Losing C/CSP sends CNA Withdrawal Rejection/ Confirmation within one Business Day of receipt of the CNA Withdrawal Notification
	Outcomes and Actions			Losing C/CSP sends CNA Withdrawal Rejection/ Confirmation within one Business Day of receipt of the CNA Withdrawal Notification Confirmations will cancel the CNA	
26	Receive Withdrawal Confirmation/Rejection	G	D		
	Outcomes and Actions			Confirmation Update the PLNR Rejection	

TWO PARTY CAT. C – Donor as Gaining C/CSP					
Legend for C/CSP: G is for Gaining C/CSP L is for Losing C/CSP D is for Donor C/CSP			Legend for File: D is for Daily PNO H is for Hot Batch		
REF	Event	C/CSP Role	File	Description	Rules
				Internal operational process	
27	Update Ported Local Number Register	G/D	N/A		The update of the PLNR will replace the existing indicator (either “D” or “E”) with a new indicator of “F” in the entry for each Telephone Number in the batch. The next update of the PLNR will remove the indicator “F” from the entry for each Telephone Number.
	Outcomes and Actions			Ported Local Number Register updated	
28	Send CCA Retarget Notification	G	D	Utilised to notify the Losing C/CSP of a change in the Cutover Date and Commencement Time	
	Outcomes and Actions				
29	Receive and Receipt CCA Retarget Notification	L	D		A batch receipt will be sent to the gaining C/CSP within one Business Day to confirm that the CCA has been received
	Outcomes and Actions				
30	Validate CCA Retarget Notification	L	D		Losing C/CSP shall validate and reject if: (a) incorrect record format (response code of 020) (b) a confirmed and active CCA Port Notification does not exist for the batch reference number for the same gaining C/CSP (response code of 057) (c) CCA Retarget date and time are not within standard hours of operations, or as otherwise agreed (response code of 034). (d) CCA Retarget for a batch number exceeds two Retargets (response code of 037). (e) the Cutover Date is not within the lifetime of the

TWO PARTY CAT. C – Donor as Gaining C/CSP					
Legend for C/CSP: G is for Gaining C/CSP L is for Losing C/CSP D is for Donor C/CSP			Legend for File: D is for Daily PNO H is for Hot Batch		
REF	Event	C/CSP Role	File	Description	Rules
					Port (response code of 054). (f) the Cutover Date and Commencement Time are not as agreed (response code of 034) (g) all mandatory fields are not populated (response code of 018) (h) CCA Retarget not received within agreed notification period (response code of 032).
	Outcomes and Actions				
31	Send CCA Retarget Confirmation/Rejection	L	D	Utilised to notify the confirmation or rejection of a CCA Retarget Notification made by the Gaining C/CSP. The invalid batch will be associated with a Response code.	Losing C/CSP sends CCA Retarget Rejection/Confirmation within three Business Day of receipt of the CCA Retarget Notification
	Outcomes and Actions				
32	Receive CCA Retarget Confirmation/Rejection	G	D		
	Outcomes and Actions				
33	Send CCA Withdrawal Notification	G	D	Utilised to notify the Losing C/CSP of a withdrawal of the CCA Port Notification made by the Gaining C/CSP.	
	Outcomes and Actions				
34	Receive and Validate CCA Withdrawal Notification	L	D		Losing C/CSP shall validate and reject if: (a) incorrect record format (response code of 020) (b) a confirmed and active CCA Cutover Notification does not exist for the Telephone Number for the same Gaining C/CSP (response code of 056)

TWO PARTY CAT. C – Donor as Gaining C/CSP					
Legend for C/CSP: G is for Gaining C/CSP L is for Losing C/CSP D is for Donor C/CSP			Legend for File: D is for Daily PNO H is for Hot Batch		
REF	Event	C/CSP Role	File	Description	Rules
					(c) not all mandatory fields are populated (response code of 018) (d) not received at least one Business Day prior to CNA expiry (response code of 032)
	Outcomes and Actions				
35	Send CCA Withdrawal Confirmation/Rejection	L	D	Utilised to notify confirmation or rejection of a CCA Withdrawal Notification made by the Gaining C/CSP.	Losing C/CSP sends CNA Withdrawal Rejection/ Confirmation within one Business Day of receipt of the CNA Withdrawal Notification
	Outcomes and Actions			Losing C/CSP sends CCA Withdrawal Rejection/ Confirmation within one Business Day of receipt of the CNA Withdrawal Notification Confirmations will cancel the CNA	
36	Receive Withdrawal Confirmation/Rejection	G	D		
	Outcomes and Actions			Confirmation Update the PLNR Rejection Internal operational process	
37	Update Ported Local Number Register	G/D	N/A		The update of the PLNR will replace the existing indicator (either "D" or "E") in the entry for each Telephone Number in the batch with a new indicator of "F". The next update of the PLNR will remove the indicator "F" from the entry for each Telephone Number.
	Outcomes and Actions			Ported Local Number Register updated	
38	Send CNA Expiry Notification	L	D	Utilised to notify the Gaining C/CSP that the valid period for the CNA Port Notification has expired and hence	Any CNA that exceeds its CNA expiry date will have an CNA Expiry Notification sent to the Gaining C/CSP one Business Day after the expiry

TWO PARTY CAT. C – Donor as Gaining C/CSP					
Legend for C/CSP: G is for Gaining C/CSP L is for Losing C/CSP D is for Donor C/CSP			Legend for File: D is for Daily PNO H is for Hot Batch		
REF	Event	C/CSP Role	File	Description	Rules
				deemed to be cancelled	date Losing C/CSP cancels the CNA
	Outcomes and Actions			Any CNA that exceeds its CNA expiry date will have an CNA Expiry Notification sent to the Gaining C/CSP one Business Day after the expiry date The CNA is no longer valid.	
39	Receive CNA Expiry Notification	G	D		
	Outcomes and Actions			Internal operational process	
40	Update Ported Local Number Register	G/D	N/A		The update of the PLNR will replace the existing indicator (either "D" or "E") with a new indicator of "F" in the entry for each Telephone Number in the batch. The next update of the PLNR will remove the indicator "F" from the entry for each Telephone Number.
	Outcomes and Actions			Ported Local Number Register updated	

5.3 Cat. C - Third Party

THIRD PARTY CAT. C					
Legend for C/CSP: G is for Gaining C/CSP L is for Losing C/CSP D is for Donor C/CSP			Legend for File: D is for Daily PNO H is for Hot Batch		
REF	Event	C/CSP Role	File	Description	Rules
1	Create and send a CNA Port Notification	G	D	Utilised to notify the Losing C/CSP of a Telephone Number being Ported to another C/CSP.	
	Outcomes and Actions			CNA included in daily PNO file for forwarding to Losing C/CSP	
2	Receive CNA Port Notification and send CNA Batch Receipt	L	D	Utilised to notify the Gaining C/CSP that the CNA Port Notification has been received.	Losing C/CSP must send a CNA Batch Receipt within one Business Day of receipt of the CNA Port Notification.
	Outcomes and Actions			The CNA Batch Receipt must be provided to the Gaining C/CSP at the Batch level.	
3	Receive CNA Batch Receipt Advice	G	D		
	Outcomes and Actions				
4	Validate CNA Port Notification	L	D		Losing C/CSP shall validate and reject if: (a) incorrect record format (response code of 020) (b) the Telephone Number is a duplicate in the batch (response code of 040) (c) a Telephone Number or Numbers could not be found for a batch (response code of 001) (d) Telephone Numbers in the Batch are already Ported to the Gaining C/CSP (response code of 009) (e) Telephone Number in the batch is already Ported to another C/CSP (response code of 010) (f) for a batch a Telephone Number or Numbers is owned and utilised by the Losing C/CSP ie. test service (response code of 011)

THIRD PARTY CAT. C					
Legend for C/CSP: G is for Gaining C/CSP L is for Losing C/CSP D is for Donor C/CSP			Legend for File: D is for Daily PNO H is for Hot Batch		
REF	Event	C/CSP Role	File	Description	Rules
					<p>(g) Telephone Number is not active or reserved (response code of 003)</p> <p>(h) Telephone Number is not associated to the appropriate exchange technology that supports Portability (response code of 015)</p> <p>(i) the Telephone Numbers and account numbers in the batch provided are not in a valid association (response code of 017)</p> <p>(j) the product associated to the Telephone Number requires Porting using the Cat. D process (response code of 063)</p> <p>(k) Telephone Numbers in the batch are in the process of being Ported (response code of 008)</p> <p>(l) Telephone Number is pending disconnection (response code of 004)</p> <p>(m) the CA date is more than 90 calendar days from receipt of the CNA Port Notification (response code of 067)</p> <p>(n) the Batch Reference Number is already associated to another active Batch for the Gaining C/CSP (response code of 077)</p> <p>(o) Telephone Numbers in the batch are not inclusive of all services associated to the Cat C product eg. Losing C/CSP product must have all Telephone Numbers identified in the CNA Port Notification refer to appendix C for examples (response code of 060)</p> <p>(p) the Telephone Numbers for a product are not contiguous in the batch (response code of 065)</p>

THIRD PARTY CAT. C					
Legend for C/CSP: G is for Gaining C/CSP L is for Losing C/CSP D is for Donor C/CSP			Legend for File: D is for Daily PNO H is for Hot Batch		
REF	Event	C/CSP Role	File	Description	Rules
					(q) the Telephone Numbers are not for a single site or location (response code of 041) (r) the project manager details are not present (response code of 018) (s) the customer contact details are not present (response code of 018) (t) the batch number is not present (response code of 061) (u) the batch is unable to be Ported due to excluded product (response code of 073) (v) the Telephone Number is valid but there is another Telephone Number that is rejected due to another primary error in the batch (response code of 064) (w) all mandatory fields are not populated (response code of 018) (x) network based diversion (eg. network service only) (response code of 002)
	Outcomes and Actions				
5	Send CNA Port Notification Confirmation/Rejection	L	D	Utilised to notify the confirmation or rejection of a CNA Port Notification made by the Gaining C/CSP. The rejection advice will show valid and invalid Telephone Numbers and an invalid Telephone Number will have an associated Response code	Losing C/CSP must send an CNA Port Notification Confirmation/Rejection within five Business Days of receipt of the CNA Port Notification
	Outcomes and Actions			Confirmation Confirmation is at the batch level. Confirmation of the CNA Port Notification will commence the expiry count down and	

THIRD PARTY CAT. C					
Legend for C/CSP: G is for Gaining C/CSP L is for Losing C/CSP D is for Donor C/CSP			Legend for File: D is for Daily PNO H is for Hot Batch		
REF	Event	C/CSP Role	File	Description	Rules
				<p>the CNA will become active.</p> <p>The expiry date for a confirmed CNA Port Notification will be set 120 days from receipt of the notification (inclusive)</p> <p>Rejection</p> <p>Rejection is at the Telephone Number level.</p> <p>Rejection of the CNA Port Notification will not make the CNA active</p>	
6	Receive CNA Port Notification Confirmation/Rejection	G	D		
	Outcomes and Actions			<p>Confirmation</p> <p>Confirmation of the CNA Port Notification will make the Port active.</p> <p>The expiry date for a confirmed CNA Port Notification will be set 120 days from receipt of the notification (inclusive).</p> <p>The Cutover should be completed within 120 calendar days of the CNA.</p> <p>Rejection</p> <p>Internal operational process</p>	
7	Create and Send a TCNA Port Notification to Donor C/CSP	G	D	Utilised to notify the Donor C/CSP of a Telephone Number being Ported to another C/CSP.	
	Outcomes and Actions			TCNA included in daily PNO file for forwarding to Donor C/CSP	
8	Receive TCNA Port Notification and send TCNA Batch Receipt	L	D	Utilised to notify the Gaining C/CSP that the TCNA Port Notification has been received.	Losing C/CSP must send a TCNA Batch Receipt within one Business Day of receipt of the TCNA Port Notification.

THIRD PARTY CAT. C					
Legend for C/CSP: G is for Gaining C/CSP L is for Losing C/CSP D is for Donor C/CSP			Legend for File: D is for Daily PNO H is for Hot Batch		
REF	Event	C/CSP Role	File	Description	Rules
	Outcomes and Actions			The TCNA Receipt Advice must be provided to the Gaining C/CSP at the batch level.	
9	Receive TCNA Batch Receipt	G	D		
	Outcomes and Actions				
10	Validate TCNA Port Notification	D	D		Donor C/CSP shall validate and reject if: (a) incorrect record format (response code of 020) (b) the Telephone Number is a duplicate in the batch (response code of 040) (c) all Telephone Numbers in the batch are not owned by the Donor (response code of 069) (d) all Telephone Numbers in the batch are not in a completed state (response code of 052) (e) all Telephone Numbers in the batch are in the process of being Ported to another C/CSP (response code of 051) (f) all Telephone Numbers in the batch are in the process of being Ported to the Gaining C/CSP (response code of 008) (g) all Telephony Numbers in the batch are already Ported to the Gaining C/CSP (response code of 009) (h) the Batch Reference Number is already associated to another active Batch for the Gaining C/CSP (response code of 077) (i) all mandatory fields are not populated (response code of 018)
	Outcomes and Actions				

THIRD PARTY CAT. C					
Legend for C/CSP: G is for Gaining C/CSP L is for Losing C/CSP D is for Donor C/CSP			Legend for File: D is for Daily PNO H is for Hot Batch		
REF	Event	C/CSP Role	File	Description	Rules
11	Send TCNA Port Notification Confirmation/Rejection	D	D	Utilised to notify the confirmation or rejection of a Port Notification made by the Gaining C/CSP.	Donor C/CSP must send TCNA Port Notification Confirmation/Rejection within two Business Day of receipt of the TCNA Port Notification
	Outcomes and Actions			Confirmation The expiry date for a confirmed TCNA Port Notification will be set to 120 days from receipt of the notification (inclusive) Confirmations will make the TCNA active. Update the Ported Local Number Register Rejection Rejections will not make the TCNA active	
12	Update Ported Local Number Register	D	N/A		The update of the PLNR will add the indicator "D" to the entry for each Telephone Number in the batch. The next update of the PLNR will replace the indicator "D" with a new indicator of "E" for the entry for each Telephone Number.
	Outcomes and Actions			Ported Local Number Register updated	
13	Receive TCNA Port Confirmation/Rejection	G	D		
	Outcomes and Actions				
14	Negotiate Cutover	G & L G & D			The project manager for the Gaining C/CSP will negotiate with the project managers for the Losing C/CSP and Donor C/CSP and agree on a Cutover Date and Commencement Time for the Port.
	Outcomes and Actions				
15	Create and send a CCA Cutover	G	D	Utilised to notify the Losing C/CSP of the	

THIRD PARTY CAT. C					
Legend for C/CSP: G is for Gaining C/CSP L is for Losing C/CSP D is for Donor C/CSP			Legend for File: D is for Daily PNO H is for Hot Batch		
REF	Event	C/CSP Role	File	Description	Rules
	Notification			agreed Cutover Date and Commencement Time for the Batch.	
	Outcomes and Actions			CCA included in daily PNO file for forwarding to Losing C/CSP	
16	Receive CCA Cutover Notification and send CCA Cutover Batch Receipt	L	D	Utilised to notify the Gaining C/CSP that the CCA Cutover Notification has been received.	Losing C/CSP must send a CCA Receipt within one Business Day of receipt of the CCA Cutover Notification.
	Outcomes and Actions			The CCA Receipt Advice must be provided to the Gaining C/CSP at the Batch level.	
17	Receive CCA Cutover Batch Receipt	G	D		
	Outcomes and Actions				
18	Validate CCA Cutover Notification	L	D		Losing C/CSP shall validate and reject if: (a) incorrect record format (response code of 020) (b) a confirmed and active CNA Port Notification does not exist for the batch reference number for the same Gaining C/CSP (response code of 035) (c) CCA Cutover Date and Commencement Time are not within standard hours of operations, or as otherwise agreed (response code of 034) (d) The CCA Cutover Date is not within the lifetime of the Port (120 calendar days from the CNA receipt date) (response code of 054) (e) the Cutover Date and Commencement Time are not as agreed (response code of 034) (f) all mandatory fields are not populated (response code of 018)

THIRD PARTY CAT. C					
Legend for C/CSP: G is for Gaining C/CSP L is for Losing C/CSP D is for Donor C/CSP			Legend for File: D is for Daily PNO H is for Hot Batch		
REF	Event	C/CSP Role	File	Description	Rules
	Outcomes and Actions				
19	Send CCA Cutover Confirmation/Rejection	L	D	Utilised to notify the confirmation or rejection of a CCA Cutover Notification made by the Gaining C/CSP. The invalid batch will be associated with a Response code.	Losing C/CSP must send an CCA Cutover Confirmation/Rejection within three Business Days of receipt of the CCA Cutover Notification
	Outcomes and Actions			Confirmation Confirmation is at the batch level. Rejection Rejection is at the batch level. Rejection of the CCA Cutover Notification will leave the CNA active	
20	Receive CCA Cutover Confirmation/Rejection	G	D		
	Outcomes and Actions			Confirmation Only CCA transaction types should be sent after CCA Confirmation is received. Rejection Leaves CNA status unchanged. Internal operational process	
21	Send TCCA Cutover Notification to Donor C/CSP	G	D	Utilised to notify the donor C/CSP of the intended Cutover Date and Commencement Time	A TCCA Cutover Notification cannot be sent prior to the receipt of a TCNA Confirmation from the Donor C/CSP.
	Outcomes and Actions				
22	Receive TCCA Cutover Notification and send TCCA Cutover Batch Receipt	D	D	Utilised to notify the Gaining C/CSP that the TCCA Port Notification has been received.	Losing C/CSP must send a TCCA Cutover Batch Receipt within one Business Day of receipt of the TCCA Cutover Notification.

THIRD PARTY CAT. C					
Legend for C/CSP: G is for Gaining C/CSP L is for Losing C/CSP D is for Donor C/CSP			Legend for File: D is for Daily PNO H is for Hot Batch		
REF	Event	C/CSP Role	File	Description	Rules
	Outcomes and Actions			The TCCA Cutover Batch Receipt must be provided to the Gaining C/CSP at the batch level.	
23	Receive TCCA Cutover Batch Receipt	G	D		
	Outcomes and Actions				
24	Validate TCCA Cutover Notification	D	D		<p>The Donor C/CSP shall validate and reject if:</p> <ul style="list-style-type: none"> (a) incorrect record format (response code of 020) (b) a confirmed and active TCNA Port Notification does not exist for the batch reference number for the same Gaining C/CSP (response code of 035) (c) the TCCA Cutover Date and Commencement Time are not within standard hours of operations or as otherwise agreed (response code of 034) (d) the Cutover Date is greater than 120 calendar days from receipt of the TCNA Port Notification (response code of 054) (e) the Cutover Date is less than five Business Days after the TCNA receipt date (response code of 032) (f) the Cutover Date is less than two Business Days from receipt of the TCCA Cutover Notification (response code of 032) (g) all mandatory fields are not populated (response code of 018)
	Outcomes and Actions				

THIRD PARTY CAT. C					
Legend for C/CSP: G is for Gaining C/CSP L is for Losing C/CSP D is for Donor C/CSP			Legend for File: D is for Daily PNO H is for Hot Batch		
REF	Event	C/CSP Role	File	Description	Rules
25	Send TCCA Cutover Confirmation/Rejection	D	D	Utilised to notify the confirmation/rejection of a TCCA Cutover Notification made by the gaining C/CSP. The invalid batch will be associated with a Response code.	
	Outcomes and Actions				
26	Receive TCCA Cutover Confirmation/Rejection	G	D		
	Outcomes and Actions			Confirmation Rejection	
27	Implement Cutover	G	N/A	Cutover is project managed.	
	Outcomes and Actions				
28	Implement Cutover	D	N/A	Cutover is project managed.	
	Outcomes and Actions			Cutover completed and all traffic for the Ported Telephone Numbers are directed to the Gaining C/CSP's network.	
31	Implement Cutover	L	N/A	Cutover is project managed.	
	Outcomes and Actions			Cutover completed and all traffic for the Ported Telephone Numbers are directed to the Gaining C/CSP's network.	
32	Agree Completion of Port	G & L G & D	N/A	Agreement reached with the project manager for the Losing C/CSP and the Donor C/CSP on Port completion.	
	Outcomes and Actions			Where the Cutover of the Port has already commenced and it is determined that the Port cannot proceed, the Emergency Return	

THIRD PARTY CAT. C					
Legend for C/CSP: G is for Gaining C/CSP L is for Losing C/CSP D is for Donor C/CSP			Legend for File: D is for Daily PNO H is for Hot Batch		
REF	Event	C/CSP Role	File	Description	Rules
				process should be used. At the expiry of the Emergency Return period following the agreement of a successful Port completion the Ported Local Number Register is updated.	
33	Update Ported Local Number Register	D	N/A	The PLNR is only updated following the end of the Transfer Reversal Period. If an Transfer Reversal is called, the PLNR is not updated.	The update of the PLNR will replace the existing C/CSP code with the new C/CSP's code and change the indicator to "B" in the entry for each Telephone Number. The next update of the PLNR will remove the indicator "B" from the entry for each Telephone Number.
	Outcomes and Actions			Ported Local Number Register updated	
34					
35					
36					
37					
38	Send CCA Retarget Notification	G	D	Utilised to notify the Losing C/CSP of a change in the Cutover Date and Commencement Time	
	Outcomes and Actions				
39	Receive and Receipt CCA Retarget Notification	L	D		A batch receipt will be sent to the gaining C/CSP within one Business Day to confirm that the CCA has been received
	Outcomes and Actions				
40	Validate CCA Retarget Notification	L	D		Losing C/CSP shall validate and reject if: (a) incorrect record format

THIRD PARTY CAT. C					
Legend for C/CSP: G is for Gaining C/CSP L is for Losing C/CSP D is for Donor C/CSP			Legend for File: D is for Daily PNO H is for Hot Batch		
REF	Event	C/CSP Role	File	Description	Rules
					(response code of 020) (b) a confirmed and active CCA Port Notification does not exist for the batch reference number for the same gaining C/CSP (response code of 057) (c) CCA Retarget date and time are not within standard hours of operations, or as otherwise agreed (response code of 034). (d) CCA Retarget for a batch number exceeds two Retargets(response code of 037). (e) the Cutover Date is not within the lifetime of the Port (response code of 054). (f) the Cutover Date and Commencement Time are not as agreed (response code of 034) (g) all mandatory fields are not populated (response code of 018) (h) CCA Retarget not received within agreed notification period (response code of 032).
	Outcomes and Actions				
41	Send CCA Retarget Confirmation/Rejection	L	D	Utilised to notify the confirmation or rejection of a CCA Retarget Notification made by the Gaining C/CSP. The invalid batch will be associated with a Response code.	Losing C/CSP sends CCA Retarget Rejection/ Confirmation within three Business Day of receipt of the CCA Retarget Notification
	Outcomes and Actions				
42	Receive CCA Retarget Confirmation/Rejection	G	D		
	Outcomes and Actions				

THIRD PARTY CAT. C					
Legend for C/CSP: G is for Gaining C/CSP L is for Losing C/CSP D is for Donor C/CSP			Legend for File: D is for Daily PNO H is for Hot Batch		
REF	Event	C/CSP Role	File	Description	Rules
43	Send TCCA Retarget Notification	G	D	Utilised to notify the Losing C/CSP of a change in the Cutover Date and Commencement Time.	
	Outcomes and Actions				
44	Receive and Receipt TCCA Retarget Notification	D	D		A batch receipt will be sent to the gaining C/CSP within one Business Day to confirm that the TCCA has been received
	Outcomes and Actions				
45	Validate TCCA Retarget Notification	D	D		Losing C/CSP shall validate and reject if: <ul style="list-style-type: none"> (a) incorrect record format (response code of 020) (b) a confirmed and active TCCA Port Notification does not exist for the batch reference number for the same gaining C/CSP (response code of 057) (c) TCCA Retarget date and time are not within standard hours of operations, or as otherwise agreed (response code of 034) (d) TCCA Retarget for a batch number exceeds two Retargets (response code of 037). (e) the Cutover Date is not within the lifetime of the Port (response code of 054). (f) the Cutover Date and Commencement Time are not as agreed (response code of 034) (g) all mandatory fields are not populated (response code of 018) (h) TCCA Retarget not received within agreed notification period (response code of 032).
	Outcomes and				

THIRD PARTY CAT. C					
Legend for C/CSP: G is for Gaining C/CSP L is for Losing C/CSP D is for Donor C/CSP			Legend for File: D is for Daily PNO H is for Hot Batch		
REF	Event	C/CSP Role	File	Description	Rules
Actions					
46	Send TCCA Retarget Confirmation/Rejection	D	D	Utilised to notify the confirmation or rejection of a TCCA Retarget Notification made by the Gaining C/CSP. The invalid batch will be associated with a Response code.	Losing C/CSP sends TCCA Retarget Rejection/ Confirmation within two Business Day of receipt of the TCCA Retarget Notification
Outcomes and Actions					
47	Receive TCCA Retarget Confirmation/Rejection	G	D		
Outcomes and Actions					
48	Send CNA Withdrawal Notification to Losing C/CSP	G	D	Utilised to notify the Losing C/CSP of a withdrawal of the original CNA Port Notification made by the Gaining C/CSP.	
Outcomes and Actions					
49	Receive and Validate CNA Withdrawal Notification	L	D		Losing C/CSP shall validate and reject if: (a) incorrect record format (response code of 020) (b) no confirmed and active CNA Port Notification exists or a confirmed CCA exists for the Telephone Number for the same Gaining C/CSP (response code of 056) (c) not all mandatory fields are populated (response code of 018) (d) not received at least one Business Day prior to CNA expiry (response code of 032)
Outcomes and Actions					
50	Send CNA Withdrawal Confirmation/Rejection	L	D	Utilised to notify confirmation or rejection of a CNA Withdrawal Notification made by the Gaining C/CSP.	Losing C/CSP sends CNA Withdrawal Rejection/ Confirmation within one Business Day of receipt of the CNA Withdrawal Notification

THIRD PARTY CAT. C					
Legend for C/CSP: G is for Gaining C/CSP L is for Losing C/CSP D is for Donor C/CSP			Legend for File: D is for Daily PNO H is for Hot Batch		
REF	Event	C/CSP Role	File	Description	Rules
	Outcomes and Actions			Losing C/CSP sends CNA Withdrawal Rejection/ Confirmation within one Business Day of receipt of the CNA Withdrawal Notification Confirmation Confirmations will cancel the CNA	
51	Receive CNA Withdrawal Confirmation/Rejection	G	D		
	Outcomes and Actions			Confirmation Rejection	
52	Send TCNA Withdrawal Notification to Donor C/CSP	G	D	Utilised to notify the Donor C/CSP of a withdrawal of the original TCNA Port Notification made by the Gaining C/CSP.	
	Outcomes and Actions				
53	Receive and Validate TCNA Withdrawal Notification	D	D		Donor C/CSP shall validate and reject if: (a) incorrect record format (response code of 020) (b) no confirmed and active TCNA port notification does not exists for the Batch reference number for the same gaining C/CSP (response code of 056) (c) no confirmed TCCA Cutover Notification exists for the Batch reference number for the same gaining C/CSP (response code of 055) (d) not all mandatory fields are populated (response code of 018) (e) not received within one Business Day of TCNA expiry (response code of 032)

THIRD PARTY CAT. C					
Legend for C/CSP: G is for Gaining C/CSP L is for Losing C/CSP D is for Donor C/CSP			Legend for File: D is for Daily PNO H is for Hot Batch		
REF	Event	C/CSP Role	File	Description	Rules
	Outcomes and Actions				
54	Send TCNA Withdrawal Confirmation/Rejection	D	D	Utilised to notify confirmation or rejection of a TCNA Withdrawal Notification made by the Gaining C/CSP.	Donor C/CSP sends TCNA Withdrawal Rejection/ Confirmation within one Business Day of receipt of the TCNA Withdrawal Notification
	Outcomes and Actions			Donor C/CSP sends TCNA Withdrawal Rejection/ Confirmation within one Business Day of receipt of the TCNA Withdrawal Notification Confirmation Confirmations will cancel the TCNA Update Ported Local Number Register	
55	Update Ported Local Number Register	D	N/A		The update of the PLNR will replace the existing indicator either "D" or "E" with a new indicator of "F" for the entry for each Telephone Number. The next update of the PLNR will remove the indicator "F" from the entry for each Telephone Number.
	Outcomes and Actions			Ported Local Number Register updated	
56	Send CCA Withdrawal Notification	G	D	Utilised to notify the Losing C/CSP of a withdrawal of the CCA Port Notification made by the Gaining C/CSP.	
	Outcomes and Actions				

THIRD PARTY CAT. C					
Legend for C/CSP: G is for Gaining C/CSP L is for Losing C/CSP D is for Donor C/CSP			Legend for File: D is for Daily PNO H is for Hot Batch		
REF	Event	C/CSP Role	File	Description	Rules
57	Receive and Validate CCA Withdrawal Notification	L	D		Losing C/CSP shall validate and reject if: (a) incorrect record format (response code of 020) (b) a confirmed and active CCA Cutover Notification does not exist for the Telephone Number for the same Gaining C/CSP (response code of 056) (c) not all mandatory fields are populated (response code of 018) (d) not received at least one Business Day prior to CNA expiry (response code of 032)
	Outcomes and Actions				
58	Send CCA Withdrawal Confirmation/Rejection	L	D	Utilised to notify confirmation or rejection of a CCA Withdrawal Notification made by the Gaining C/CSP.	Losing C/CSP sends CNA Withdrawal Rejection/ Confirmation within one Business Day of receipt of the CNA Withdrawal Notification
	Outcomes and Actions			Losing C/CSP sends CCA Withdrawal Rejection/ Confirmation within one Business Day of receipt of the CNA Withdrawal Notification Confirmations will cancel the CNA	
59	Receive CCA Withdrawal Confirmation/Rejection	G	D		
	Outcomes and Actions				
60	Send TCCA Withdrawal Notification	G	D	Utilised to notify the Losing C/CSP of a withdrawal of the TCCA Port Notification made by the Gaining C/CSP.	
	Outcomes and Actions				
61	Receive and Validate TCCA Withdrawal	D	D		Losing C/CSP shall validate and reject if: (a) incorrect record format

THIRD PARTY CAT. C					
Legend for C/CSP: G is for Gaining C/CSP L is for Losing C/CSP D is for Donor C/CSP			Legend for File: D is for Daily PNO H is for Hot Batch		
REF	Event	C/CSP Role	File	Description	Rules
	Notification				(response code of 020) (b) a confirmed and active TCCA Cutover Notification does not exist for the Telephone Number for the same Gaining C/CSP (response code of 056) (c) not all mandatory fields are populated (response code of 018) (d) not received at least one Business Day prior to TCCA Cutover Date (response code of 032)
	Outcomes and Actions				
62	Send TCCA Withdrawal Confirmation/Rejection	D	D	Utilised to notify confirmation or rejection of a TCCA Withdrawal Notification made by the Gaining C/CSP.	Losing C/CSP sends TCCA Withdrawal Rejection/ Confirmation within one Business Day of receipt of the TCCA Withdrawal Notification
	Outcomes and Actions			Losing C/CSP sends TCCA Withdrawal Rejection/ Confirmation within one Business Day of receipt of the TCNA Withdrawal Notification Confirmations will cancel the TCNA	
63	Update Ported Local Number Register	D	N/A		The update of the PLNR will replace the existing indicator (either "D" or "E") with a new indicator of "F" in the entry for each Telephone Number in the batch. The next update of the PLNR will remove the indicator "F" from the entry for each Telephone Number.
	Outcomes and Actions			Ported Local Number Register updated	
64	Receive Withdrawal Confirmation/Rejection	G	D		
	Outcomes and Actions				

THIRD PARTY CAT. C					
Legend for C/CSP: G is for Gaining C/CSP L is for Losing C/CSP D is for Donor C/CSP			Legend for File: D is for Daily PNO H is for Hot Batch		
REF	Event	C/CSP Role	File	Description	Rules
65	Send CNA Expiry Notification	L	D	Utilised to notify the Gaining C/CSP that the valid period for the CNA Port Notification has expired and hence deemed to be cancelled	Any CNA that exceeds its CNA expiry date will have an CNA Expiry Notification sent to the gaining C/CSP one Business Day after the expiry date Losing C/CSP cancels the CNA
	Outcomes and Actions			Any CNA that exceeds its CNA expiry date will have an CNA Expiry Notification sent to the gaining C/CSP one Business Day after the expiry date The CNA is no longer valid.	
66	Receive CNA Expiry Notification	G	D		
	Outcomes and Actions			Internal operational process	
67	Send TCNA Expiry Notification	D	D	Utilised to notify the Gaining C/CSP that the valid period for the TCNA Port Notification has expired and hence deemed to be cancelled	Any TCNA that exceeds its TCNA expiry date will have an TCNA Expiry Notification sent to the Gaining C/CSP one Business Day after the expiry date Losing C/CSP cancels the TCNA
	Outcomes and Actions			Any TCNA that exceeds its TCNA expiry date will have an TCNA Expiry Notification sent to the Gaining C/CSP one Business Day after the expiry date The TCNA is no longer valid.	
68	Receive TCNA Expiry Notification	G	D		
	Outcomes and Actions			Internal operational process	
69	Update Ported Local Number Register	D	N/A		The update of the PLNR will replace the existing indicator (either "D" or "E") with a new indicator of "F" in the entry for each Telephone Number in the batch.

THIRD PARTY CAT. C					
Legend for C/CSP: G is for Gaining C/CSP L is for Losing C/CSP D is for Donor C/CSP			Legend for File: D is for Daily PNO H is for Hot Batch		
REF	Event	C/CSP Role	File	Description	Rules
					The next update of the PLNR will remove the indicator "F" from the entry for each Telephone Number.
	Outcomes and Actions			Ported Local Number Register updated	

6 CAT. C – THIRD PARTY PORT ACTIVITY

Third Party Porting requires the Gaining C/CSP to carefully co-ordinate activities with both the Donor C/CSP and the Losing C/CSP. The tables below provide guidance in the activity that can occur in various Porting scenarios.

6.1 Port Initiated

Losing C/CSP Response	Donor Response	Port Still Proceeding	Port Not Proceeding	No Action by Gaining C/CSP
CNA Rejected	TCNA Rejected	Issue new CNA and TCNA	No further action required	N/A
CNA Confirmed	TCNA Rejected	Issue new TCNA	Issue CNA Withdrawal or allow CNA to Expire	CNA will expire
CNA Rejected	TCNA Confirmed	Issue new CNA	Issue TCNA Withdrawal or allow TCNA to Expire	TCNA will expire
CNA Confirmed	TCNA Confirmed	Agree Cutover Date and Commencement Time and issue CCA & TCCA	Issue CNA & TCNA Withdrawal or allow Port to Expire	CNA & TCNA will expire

6.2 Port Cutover

Losing C/CSP Response	Donor Response	Port Still Proceeding	Port Not Proceeding	No Action by Gaining C/CSP
CCA Rejected	TCCA Rejected	Issue new CCA and TCCA	No further action required	CNA and TCNA will expire
CCA Confirmed	TCCA Rejected	Issue new TCCA	Issue CCA Withdrawal before agreed Cutover Date or use Emergency Return after the Port has completed	The Port will be completed by the Losing C/CSP but the Transfer will not be completed.
CCA Rejected	TCCA Confirmed	Issue new CCA	Issue TCCA Withdrawal before agreed Cutover Date or use Transfer Reversal after the Transfer has completed	The Transfer will be completed by the Donor C/CSP but the Port will not be completed.

Losing C/CSP Response	Donor Response	Port Still Proceeding	Port Not Proceeding	No Action by Gaining C/CSP
CCA Confirmed	TCCA Confirmed	No further action required. Port will completed on agreed Date.	Issue CCA & TCCA Withdrawal before agreed Cutover Date or use Emergency Return and Transfer Reversal after the Port and Transfer have completed	Both the Port and Transfer will be completed

6.3 CCA/TCCA Retarget

Losing C/CSP Response	Donor Response	Port Still Proceeding	Port Not Proceeding	No Action by Gaining C/CSP
CCA Retarget Rejected	TCCA Retarget Rejected	Issue new CCA Retarget and new TCCA Retarget	Issue CCA Withdrawal and TCCA Withdrawal before previously agreed Cutover Date.	Port and Transfer will be completed on the previously agreed Cutover date and Commencement Time.
CCA Retarget Confirmed	TCCA Retarget Rejected	Issue new TCCA Retarget	Issue CCA Withdrawal and TCCA Withdrawal before agreed Cutover Dates.	Port and Transfer will be completed on different days and at the different times.
CCA Retarget Rejected	TCCA Retarget Confirmed	Issue new CCA Retarget	Issue CCA Withdrawal and TCCA Withdrawal before agreed Cutover Dates.	Port and Transfer will be completed on different days and at the different times.
CCA Retarget Confirmed	TCCA Retarget Confirmed	No further action required	Issue CCA Withdrawal and TCCA Withdrawal before new agreed Cutover Date.	Port and Transfer will be completed on the same day and at the same time.

6.4 CNA/TCNA Withdrawal

Losing C/CSP Response	Donor Response	Port Still Proceeding	Port Not Proceeding	No Action by Gaining C/CSP
CNA Withdrawal Rejected	TCNA Withdrawal Rejected	No further Withdrawal action required.	Issue new CNA Withdrawal and a new TCNA Withdrawal or allow CNA and TCNA to expire.	CNA and TCNA will expire.
CNA Withdrawal Confirmed	TCNA Withdrawal Rejected	Issue new CNA.	Issue new TCNA Withdrawal or allow TCNA to expire.	TCNA will expire.
CNA Withdrawal Rejected	TCNA Withdrawal Confirmed	Issue new TCNA.	Issue new CNA Withdrawal or allow CNA to expire.	CNA will expire.
CNA Withdrawal Confirmed	TCNA Withdrawal Confirmed	Issue new CNA and TCNA.	No further action required.	Port will not proceed.

6.5 CCA/TCCA Withdrawal

Losing C/CSP Response	Donor Response	Port Still Proceeding	Port Not Proceeding	No Action by Gaining C/CSP
CCA Withdrawal Rejected	TCCA Withdrawal Rejected	No further action required unless Cutover Date and Commencement Time are to change.	Issue new CCA Withdrawal and new TCCA Withdrawal before previously agreed Cutover Date or use Emergency Return and Transfer Reversal after the Port and Transfer have completed.	Port and Transfer will be completed on the previously agreed Cutover Date and Commencement Time.
CCA Withdrawal Confirmed	TCCA Withdrawal Rejected	Issue new CNA.	Issue new TCCA Withdrawal before previously agreed Cutover Date or use Transfer Reversal after the Transfer has completed.	Transfer will be completed but Port will not occur.
CCA Withdrawal Rejected	TCCA Withdrawal Confirmed	Issue new TCNA.	Issue new CCA Withdrawal before previously agreed Cutover Date or use Emergency Return after the Port has completed.	Port will be completed but Transfer will not occur.
CCA Withdrawal Confirmed	TCCA Withdrawal Confirmed	Issue new CNA and TCNA.	No further action required	Port will not proceed.

6.6 Port Expiry

Losing C/CSP Response	Donor Response	Port Still Proceeding	Port Not Proceeding	No Action by Gaining C/CSP
CNA Expired	TCNA Expired	Issue new CNA and TCNA	No further action required	N/A
CNA Active	TCNA Expired	Issue new TCNA	Issue CNA Withdrawal or allow CNA to Expire	CNA will expire
CNA Expired	TCNA Active	Issue new CNA	Issue TCNA Withdrawal or allow TCNA to Expire	TCNA will expire
CNA Active	TCNA Active	Agree Cutover Date and Commencement Time and issue CCA & TCCA before expiry.	Issue CNA & TCNA Withdrawal or allow Port to Expire	CNA & TCNA will expire

7 CAT. C – PORTING TIME FRAMES

	Confirmation/ Reject	Receipt Advice	Limit (for confirmations)	Completion	Expiry	Comments
Customer Authorisation	N/A	N/A	N/A	N/A	90 Calendar Days	
CNA (C)	Five Business Days	One Business Day	One		120 Calendar Days	
CNA Withdrawal (C)	One Business Day	N/A	One	N/A	N/A	Must be sent one Business day prior to the cutover date. Add to Code?
CCA (C)	Three Business Days	One Business Day	One	N/A	N/A	Must be sent 3 Business day prior to the Expiry date.
CCA Retarget (C)	Three Business Days	One Business Day	Two	N/A	N/A	
CCA Withdrawal (C)	One Business Day	N/A	One	N/A	N/A	Must be provided at least one Clear Business Day prior to Agreed Cutover Date
TCNA (C)	Two Business Days	One Business Day	One		120 Calendar Days	
TCNA Withdrawal (C)	One Business Day	N/A	One	N/A	N/A	Must be sent one Business day prior to the Expiry date.
TCCA (C)	Two Business Days	One Business Day	One	N/A	N/A	
TCCA Retarget (C)	Two Business Days	One Business Day	Two		N/A	Must be received by the Donor Carrier no later than two Business Day prior to Agreed Cutover Date
TCCA Withdrawal (C)	One Business Day	N/A	One	N/A	N/A	Must be provided to the Donor Carrier one Business Day prior to Agreed Cutover Date

8 CAT. C – RECORD DESCRIPTION

8.1 CNA Port Notification

Attribute Name	Data Type	Start	Finish	Value	Mandatory	Description
Record Version	NUM(2)	1	2	01	Y	
Record Type	NUM(3)	3	5	040	Y	
Record Identifier	CHAR(3)	6	8	REQ	Y	
Batch Reference Number	NUM(9)	9	17		Y	Value is other than zeroes
Telephone Number	NUM(10)	18	27		Y	Full National Number e.g. 0396342223
Account Number	CHAR(25)	28	52		Y	Value other than spaces
Group Batch Reference Number	NUM(4)	53	56		N	Default value is "0000"
Category Type	CHAR(1)	57	57	C	Y	
CA Date	DATE(8)	58	65		Y	Format CCYYMMDD
Gaining C/CSP Project Manager's First Name	CHAR(20)	66	85		Y	Value is other than spaces
Gaining C/CSP Project Manager's Last Name	CHAR(30)	86	115		Y	Value is other than spaces
Gaining C/CSP Project Manager's Phone No	NUM(10)	116	125		Y	Value is other than zeroes
Gaining C/CSP Project Manager's Fax No	NUM(10)	126	135		Y	Value is other than zeroes
Gaining C/CSP Project Manager's Mobile No	NUM(10)	136	145		N	
Customer's Contact First Name	CHAR(20)	146	165		Y	Value is other than spaces
Customer's Contact Last Name	CHAR(30)	166	195		Y	Value is other than spaces
Customer's Contact Phone	NUM(10)	196	205		Y	Value is other than zeroes

Attribute Name	Data Type	Start	Finish	Value	Mandatory	Description
No						
Customer's Contact Fax No	NUM(10)	206	215		N	
Customer's Contact Mobile No	NUM(10)	216	225		N	
Filler	CHAR(25)	226	250			

8.2 CNA Batch Receipt

Attribute Name	Data Type	Start	Finish	Value	Mandatory	Description
Record Version	NUM(2)	1	2	01	Y	
Record Type	NUM(3)	3	5	040	Y	
Record Identifier	CHAR(3)	6	8	ACK	Y	
Batch Reference Number	NUM(9)	9	17		Y	Value is other than zeroes
Filler	CHAR(233)	18	250			

8.3 CNA Port Notification Confirmation

Attribute Name	Data Type	Start	Finish	Value	Mandatory	Description
Record Version	NUM(2)	1	2	01	Y	
Record Type	NUM(3)	3	5	040	Y	
Record Identifier	CHAR(3)	6	8	RSP	Y	
Batch Reference Number	NUM(9)	9	17		Y	Value is other than zeroes
Response Code	NUM(3)	18	20	000	Y	
Losing C/CSP Project Manager's First Name	CHAR(20)	21	40		Y	Value is other than spaces
Losing C/CSP Project Manager's Last Name	CHAR(30)	41	70		Y	Value is other than spaces
Losing C/CSP Project Manager's Phone No	NUM(10)	71	80		Y	Value is other than zeroes
Losing C/CSP Project Manager's Fax No	NUM(10)	81	90		Y	Value is other than zeroes
Losing C/CSP Project Manager's Mobile No	NUM(10)	91	100		N	
Filler	CHAR(150)	101	250			

8.4 CNA Port Notification Rejection

Attribute Name	Data Type	Start	Finish	Value	Mandatory	Description
Record Version	NUM(3)	1	2	01	Y	
Record Type	NUM(2)	3	5	040	Y	
Record Identifier	CHAR(3)	6	8	RSP	Y	
Batch Reference Number	NUM(9)	9	17		Y	Value is other than zeroes
Response Code	NUM(3)	18	20		Y	Must be a valid Code from Section 1
Telephone Number	NUM(10)	21	30		Y	Full National Number e.g. 0396342223
Filler	CHAR(220)	31	250			

8.5 CNA Withdrawal Notification

Attribute Name	Data Type	Start	Finish	Value	Mandatory	Description
Record Version	NUM(2)	1	2	01	Y	
Record Type	NUM(3)	3	5	042	Y	
Record Identifier	CHAR(3)	6	8	REQ	Y	
Batch Reference Number	NUM(9)	9	17		Y	Value is other than zeroes
Filler	CHAR(233)	18	250			

8.6 CNA Withdrawal Confirmation

Attribute Name	Data Type	Start	Finish	Value	Mandatory	Description
Record Version	NUM(2)	1	2	01	Y	
Record Type	NUM(3)	3	5	042	Y	
Record Identifier	CHAR(3)	6	8	RSP	Y	
Batch Reference Number	NUM(9)	9	17		Y	Value is other than zeroes
Response Code	NUM(3)	18	20	000	Y	
Filler	CHAR(230)	21	250			

8.7 CNA Withdrawal Rejection

Attribute Name	Data Type	Start	Finish	Value	Mandatory	Description
Record Version	NUM(2)	1	2	01	Y	
Record Type	NUM(3)	3	5	042	Y	
Record Identifier	CHAR(3)	6	8	RSP	Y	
Batch Reference Number	NUM(9)	9	17		Y	Value is other than zeroes
Response Code	NUM(3)	18	20		Y	Must be a valid Code from Section 1
Filler	CHAR(230)	21	250			

8.8 CCA Cutover Notification

Attribute Name	Data Type	Start	Finish	Value	Mandatory	Description
Record Version	NUM(2)	1	2	01	Y	
Record Type	NUM(3)	3	5	043	Y	
Record Identifier	CHAR(3)	6	8	REQ	Y	
Batch Reference Number	NUM(9)	9	17		Y	Value is other than zeroes
Cutover Date	DATE(8)	18	25		Y	Format CCYYMMDD
Commencement Time	NUM(4)	26	29		Y	Format HHMM in the range "0000" to "2359".
Time Zone	NUM(4)	30	33		Y	Format HHMM.
Filler	CHAR(217)	34	250			

8.9 CCA Cutover Batch Receipt

Attribute Name	Data Type	Start	Finish	Value	Mandatory	Description
Record Version	NUM(2)	1	2	01	Y	
Record Type	NUM(3)	3	5	043	Y	
Record Identifier	CHAR(3)	6	8	ACK	Y	
Batch Reference Number	NUM(9)	9	17		Y	Value is other than zeroes
Filler	CHAR(233)	18	250			

8.10 CCA Cutover Notification Confirmation

Attribute Name	Data Type	Start	Finish	Value	Mandatory	Description
Record Version	NUM(2)	1	2	01	Y	
Record Type	NUM(3)	3	5	043	Y	
Record Identifier	CHAR(3)	6	8	RSP	Y	
Batch Reference Number	NUM(9)	9	17		Y	Value is other than zeroes
Response Code	NUM(3)	18	20	000	Y	
Filler	CHAR(230)	21	250			

8.11 CCA Cutover Notification Rejection

Attribute Name	Data Type	Start	Finish	Value	Mandatory	Description
Record Version	NUM(2)	1	2	01	Y	
Record Type	NUM(3)	3	5	043	Y	
Record Identifier	CHAR(3)	6	8	RSP	Y	
Batch Reference Number	NUM(9)	9	17		Y	Value is other than zeroes
Response Code	NUM(3)	18	20		Y	Must be a valid Code from Section 1
Filler	CHAR(230)	21	250			

8.12 CCA Retarget Notification

Attribute Name	Data Type	Start	Finish	Value	Mandatory	Description
Record Version	NUM(2)	1	2	01	Y	
Record Type	NUM(3)	3	5	044	Y	
Record Identifier	CHAR(3)	6	8	REQ	Y	
Batch Reference Number	NUM(9)	9	17		Y	Value is other than zeroes
Cutover Date	DATE(8)	18	25		Y	Format CCYYMMDD
Commencement Time	NUM(4)	26	29		Y	Format HHMM in the range "0000" to "2359".
Time Zone	NUM(4)	30	33		Y	Format HHMM.
Filler	CHAR(217)	34	250			

8.13 CCA Retarget Receipt

Attribute Name	Data Type	Start	Finish	Value	Mandatory	Description
Record Version	NUM(2)	1	2	01	Y	
Record Type	NUM(3)	3	5	044	Y	
Record Identifier	CHAR(3)	6	8	ACK	Y	
Batch Reference Number	NUM(9)	9	17		Y	Value is other than zeroes
Filler	CHAR(233)	18	250			

8.14 CCA Retarget Confirmation

Attribute Name	Data Type	Start	Finish	Value	Mandatory	Description
Record Version	NUM(2)	1	2	01	Y	
Record Type	NUM(3)	3	5	044	Y	
Record Identifier	CHAR(3)	6	8	RSP	Y	
Batch Reference Number	NUM(9)	9	17		Y	Value is other than zeroes
Response Code	NUM(3)	18	20	000	Y	
Filler	CHAR(230)	21	250			

8.15 CCA Retarget Rejection

Attribute Name	Data Type	Start	Finish	Value	Mandatory	Description
Record Version	NUM(2)	1	2	01	Y	
Record Type	NUM(3)	3	5	044	Y	
Record Identifier	CHAR(3)	6	8	RSP	Y	
Batch Reference Number	NUM(9)	9	17		Y	Value is other than zeroes
Response Code	NUM(3)	18	20		Y	Must be a valid Code from Section 1
Filler	CHAR(230)	21	250			

8.16 CCA Withdrawal Notification

Attribute Name	Data Type	Start	Finish	Value	Mandatory	Description
Record Version	NUM(2)	1	2	01	Y	
Record Type	NUM(3)	3	5	045	Y	
Record Identifier	CHAR(3)	6	8	REQ	Y	
Batch Reference Number	NUM(9)	9	17		Y	Value is other than zeroes
Filler	CHAR(233)	18	250			

8.17 CCA Withdrawal Confirmation

Attribute Name	Data Type	Start	Finish	Value	Mandatory	Description
Record Version	NUM(2)	1	2	01	Y	
Record Type	NUM(3)	3	5	045	Y	
Record Identifier	CHAR(3)	6	8	RSP	Y	
Batch Reference Number	NUM(9)	9	17		Y	Value is other than zeroes
Response Code	NUM(3)	18	20	000	Y	
Filler	CHAR(230)	21	250			

8.18 CCA Withdrawal Rejection

Attribute Name	Data Type	Start	Finish	Value	Mandatory	Description
Record Version	NUM(2)	1	2	01	Y	
Record Type	NUM(3)	3	5	045	Y	
Record Identifier	CHAR(3)	6	8	RSP	Y	
Batch Reference Number	NUM(9)	9	17		Y	Value is other than zeroes
Response Code	NUM(3)	18	20		Y	Must be a valid Code from Section 1
Filler	CHAR(230)	21	250			

8.19 CNA Expiry Notification

Attribute Name	Data Type	Start	Finish	Value	Mandatory	Description
Record Version	NUM(2)	1	2	01	Y	
Record Type	NUM(3)	3	5	046	Y	
Record Identifier	CHAR(3)	6	8	REQ	Y	
Batch Reference Number	NUM(9)	9	17		Y	Value is other than zeroes
Filler	CHAR(233)	18	250			

8.20 TCNA Port Notification

Attribute Name	Data Type	Start	Finish	Value	Mandatory	Description
Record Version	NUM(2)	1	2	01	Y	
Record Type	NUM(3)	3	5	050	Y	
Record Identifier	CHAR(3)	6	8	REQ	Y	
Batch Reference Number	NUM(9)	9	17		Y	Value is other than zeroes
Telephone Number	NUM(10)	18	27		Y	Full National Number e.g. 0396342223
Gaining C/CSP Project Manager's First Name	CHAR(20)	28	47		Y	Value is other than spaces
Gaining C/CSP Project Manager's Last Name	CHAR(30)	48	77		Y	Value is other than spaces
Gaining C/CSP Project Manager's Phone No	NUM(10)	78	87		Y	Value is other than zeroes
Gaining C/CSP Project Manager's Fax No	NUM(10)	88	97		Y	Value is other than zeroes
Gaining C/CSP Project Manager's Mobile No	NUM(10)	98	107		N	
Filler	CHAR(143)	108	250			

8.21 TCNA Port Notification Batch Receipt

Attribute Name	Data Type	Start	Finish	Value	Mandatory	Description
Record Version	NUM(2)	1	2	01	Y	
Record Type	NUM(3)	3	5	050	Y	
Record Identifier	CHAR(3)	6	8	ACK	Y	
Batch Reference Number	NUM(9)	9	17		Y	Value is other than zeroes
Filler	CHAR(233)	18	250			

8.22 TCNA Port Notification Confirmation

Attribute Name	Data Type	Start	Finish	Value	Mandatory	Description
Record Version	NUM(2)	1	2	01	Y	
Record Type	NUM(3)	3	5	050	Y	
Record Identifier	CHAR(3)	6	8	RSP	Y	
Batch Reference Number	NUM(9)	9	17		Y	Value is other than zeroes
Response Code	NUM(3)	18	20	000	Y	
Donor C/CSP Project Manager's First Name	CHAR(20)	21	40		Y	Value is other than spaces
Donor C/CSP Project Manager's Last Name	CHAR(30)	41	70		Y	Value is other than spaces
Donor C/CSP Project Manager's Phone No	NUM(10)	71	80		Y	Value is other than zeroes
Donor C/CSP Project Manager's Fax No	NUM(10)	81	90		Y	Value is other than zeroes
Donor C/CSP Project Manager's Mobile No	CHARNUM(10)	91	100		N	
Filler	CHAR(150)	101	250			

8.23 TCNA Port Notification Rejection

Attribute Name	Data Type	Start	Finish	Value	Mandatory	Description
Record Version	NUM(2)	1	2	01	Y	
Record Type	NUM(3)	3	5	050	Y	
Record Identifier	CHAR(3)	6	8	RSP	Y	
Batch Reference Number	NUM(9)	9	17		Y	Value is other than zeroes
Response Code	NUM(3)	18	20		Y	Must be a valid Code from Section 1
Telephone Number	NUM(10)	21	30		Y	Full National Number e.g. 0396342223
Filler	CHAR(220)	31	250			

8.24 TCNA Withdrawal Notification

Attribute Name	Data Type	Start	Finish	Value	Mandatory	Description
Record Version	NUM(2)	1	2	01	Y	
Record Type	NUM(3)	3	5	051	Y	
Record Identifier	CHAR(3)	6	8	REQ	Y	
Batch Reference Number	NUM(9)	9	17		Y	Value is other than zeroes
Filler	CHAR(233)	18	250			

8.25 TCNA Withdrawal Confirmation

Attribute Name	Data Type	Start	Finish	Value	Mandatory	Description
Record Version	NUM(2)	1	2	01	Y	
Record Type	NUM(3)	3	5	051	Y	
Record Identifier	CHAR(3)	6	8	RSP	Y	
Batch Reference Number	NUM(9)	9	17		Y	Value is other than zeroes
Response Code	NUM(3)	18	20	000	Y	
Filler	CHAR(230)	21	250			

8.26 TCNA Withdrawal Rejection

Attribute Name	Data Type	Start	Finish	Value	Mandatory	Description
Record Version	NUM(2)	1	2	01	Y	
Record Type	NUM(3)	3	5	051	Y	
Record Identifier	CHAR(3)	6	8	RSP	Y	
Batch Reference Number	NUM(9)	9	17		Y	Value is other than zeroes
Response Code	NUM(3)	18	20		Y	Must be a valid Code from Section 1
Filler	CHAR(230)	21	250			

8.27 TCCA Cutover Notification

Attribute Name	Data Type	Start	Finish	Value	Mandatory	Description
Record Version	NUM(2)	1	2	01	Y	
Record Type	NUM(3)	3	5	052	Y	
Record Identifier	CHAR(3)	6	8	REQ	Y	
Batch Reference Number	NUM(9)	9	17		Y	Value is other than zeroes
Cutover Date	DATE(8)	18	25		Y	Format CCYYMMDD
Commencement Time	NUM(4)	26	29		Y	Format HHMM in the range "0000" to "2359".
Time Zone	NUM(4)	30	33		Y	Format HHMM in the range "0800" to "1100".
Filler	CHAR(217)	34	250			

8.28 TCCA Cutover Batch Receipt

Attribute Name	Data Type	Start	Finish	Value	Mandatory	Description
Record Version	NUM(2)	1	2	01	Y	
Record Type	NUM(3)	3	5	052	Y	
Record Identifier	CHAR(3)	6	8	ACK	Y	
Batch Reference Number	NUM(9)	9	17		Y	Value is other than zeroes
Filler	CHAR(233)	18	250			

8.29 TCCA Cutover Confirmation

Attribute Name	Data Type	Start	Finish	Value	Mandatory	Description
Record Version	NUM(2)	1	2	01	Y	
Record Type	NUM(3)	3	5	052	Y	
Record Identifier	CHAR(3)	6	8	RSP	Y	
Batch Reference Number	NUM(9)	9	17		Y	Value is other than zeroes
Response Code	NUM(3)	18	20	000	Y	
Filler	CHAR(230)	21	250			

8.30 TCCA Cutover Rejection

Attribute Name	Data Type	Start	Finish	Value	Mandatory	Description
Record Version	NUM(2)	1	2	01	Y	
Record Type	NUM(3)	3	5	052	Y	
Record Identifier	CHAR(3)	6	8	RSP	Y	
Batch Reference Number	NUM(9)	9	17		Y	Value is other than zeroes
Response Code	NUM(3)	18	20		Y	Must be a valid Code from Section 1
Filler	CHAR(230)	21	250			

8.31 TCCA Retarget Notification

Attribute Name	Data Type	Start	Finish	Value	Mandatory	Description
Record Version	NUM(2)	1	2	01	Y	
Record Type	NUM(3)	3	5	053	Y	
Record Identifier	CHAR(3)	6	8	REQ	Y	
Batch Reference Number	NUM(9)	9	17		Y	Value is other than zeroes
Cutover Date	DATE(8)	18	25		Y	Format CCYYMMDD.
Commencement Time	NUM(4)	26	29		Y	Format HHMM in the range "0000" to "2359".
Time Zone	NUM(4)	30	33		Y	Format HHMM in the range "0800" to "1100".
Filler	CHAR(217)	34	250			

8.32 TCCA Retarget Receipt

Attribute Name	Data Type	Start	Finish	Value	Mandatory	Description
Record Version	NUM(2)	1	2	01	Y	
Record Type	NUM(3)	3	5	053	Y	
Record Identifier	CHAR(3)	6	8	ACK	Y	
Batch Reference Number	NUM(9)	9	17		Y	Value is other than zeroes
Filler	CHAR(233)	18	250			

8.33 TCCA Retarget Confirmation

Attribute Name	Data Type	Start	Finish	Value	Mandatory	Description
Record Version	NUM(2)	1	2	01	Y	
Record Type	NUM(3)	3	5	053	Y	
Record Identifier	CHAR(3)	6	8	RSP	Y	
Batch Reference Number	NUM(9)	9	17		Y	Value is other than zeroes
Response Code	NUM(3)	18	20	000	Y	
Filler	CHAR(230)	21	250			

8.34 TCCA Retarget Rejection

Attribute Name	Data Type	Start	Finish	Value	Mandatory	Description
Record Version	NUM(2)	1	2	01	Y	
Record Type	NUM(3)	3	5	053	Y	
Record Identifier	CHAR(3)	6	8	RSP	Y	
Batch Reference Number	NUM(9)	9	17		Y	Value is other than zeroes
Response Code	NUM(3)	18	20		Y	Must be a valid Code from Section 1
Filler	CHAR(230)	21	250			

8.35 TCCA Withdrawal Notification

Attribute Name	Data Type	Start	Finish	Value	Mandatory	Description
Record Version	NUM(2)	1	2	01	Y	
Record Type	NUM(3)	3	5	054	Y	
Record Identifier	CHAR(3)	6	8	REQ	Y	
Batch Reference Number	NUM(9)	9	17		Y	Value is other than zeroes
Filler	CHAR(233)	18	250			

8.36 TCCA Withdrawal Confirmation

Attribute Name	Data Type	Start	Finish	Value	Mandatory	Description
Record Version	NUM(2)	1	2	01	Y	
Record Type	NUM(3)	3	5	054	Y	
Record Identifier	CHAR(3)	6	8	RSP	Y	
Batch Reference Number	NUM(9)	9	17		Y	Value is other than zeroes
Response Code	NUM(3)	18	20	000	Y	
Filler	CHAR(230)	21	250			

8.37 TCCA Withdrawal Rejection

Attribute Name	Data Type	Start	Finish	Value	Mandatory	Description
Record Version	NUM(2)	1	2	01	Y	
Record Type	NUM(3)	3	5	054	Y	
Record Identifier	CHAR(3)	6	8	RSP	Y	
Batch Reference Number	NUM(9)	9	17		Y	Value is other than zeroes
Response Code	NUM(3)	18	20		Y	Must be a valid Code from Section 1
Filler	CHAR(230)	21	250			

8.38 TCNA Expiry Notification

Attribute Name	Data Type	Start	Finish	Value	Mandatory	Description
Record Version	NUM(2)	1	2	01	Y	
Record Type	NUM(3)	3	5	056	Y	
Record Identifier	CHAR(3)	6	8	REQ	Y	
Batch Reference Number	NUM(9)	9	17		Y	Value is other than zeroes
Filler	CHAR(233)	18	250			

9 CAT. C – RESPONSE CODES

Reject Reason	LNP Reject Description	LNP Further Explanation	CNA	CNA Withdrawal	CCA	CCA Retarget	CCA Withdrawal	TCNA	TCNA Withdrawal	TCCA	TCCA Retarget	TCCA Withdrawal
001	Service Number Not Found	Invalid Service / not present on ASD systems	√									
002	Service Number is on Diversion	Service is on Network Based Call Diversion ie. no access line	√									
003	Inactive Service	Service has been Temporarily Disconnected Customer request	√									
004	Disconnected Service	Service is Disconnected or Pending Disconnection	√									
005	Complex Service – eg ISDN, Line Hunt etc											
006	ULLS Call Diversion does not exist on requested Telephone Number											
007	ULLS Number/Telephone Number mismatch											
008	Outstanding porting request	Subsequent request rejected	√					√				
009	Porting Already Completed	Porting request received from the current Recipient C/CSP	√					√				
010	Telephone Number Ported to Another ASD	Already Ported	√									

Reject Reason	LNP Reject Description	LNP Further Explanation	CNA	CNA Withdrawal	CCA	CCA Retarget	CCA Withdrawal	TCNA	TCNA Withdrawal	TCCA	TCCA Retarget	TCCA Withdrawal
011	ASD Owned Telephone Number	ASD Test Line, etc	√									
012	Not Used											
013	Not Used											
014	Not Used											
015	Incompatible Exchange Technology	Exchange Equipment or Software Version	√									
016	Not Used											
017	Telephone Number / Account Mismatch	Notification or Cutover	√									
018	All mandatory fields are not populated	Mandatory data not provided	√	√	√	√	√	√	√	√	√	√
019	Not Used											
020	Transaction Level Rejections	Incorrectly formatted record	√	√	√	√	√	√	√	√	√	√
021	Not Used											
022	Not Used											
023	Not Used											
024	Not Used											
025	Not Used											

Reject Reason	LNP Reject Description	LNP Further Explanation	CNA	CNA Withdrawal	CCA	CCA Retarget	CCA Withdrawal	TCNA	TCNA Withdrawal	TCCA	TCCA Retarget	TCCA Withdrawal
026	Not Used											
027	Not Used											
028	Losing C/CSP not the Donor C/CSP	Only applicable for Cat-D										
029	ULL request not completed											
030	ULLS call diversion greater than 30 days	ULLS call diversion greater than 30 days, has expired										
031	Not Used											
032	Insufficient notification time frame	Notification or Cutover		√		√	√		√	√	√	√
033	Not Used											
034	Cutover outside agreed hours	Agreed hrs 0700 - 1659			√	√				√	√	
035	No Porting Request is currently outstanding	Porting Notification is not confirmed or has expired			√					√		
036	Invalid Cutover Timeslot											
037	Retarget Limit exceeded	Maximum two Retargets only				√					√	
038	Giveback Invalid	EG: Not currently Ported										
039	Not Used											

Reject Reason	LNP Reject Description	LNP Further Explanation	CNA	CNA Withdrawal	CCA	CCA Retarget	CCA Withdrawal	TCNA	TCNA Withdrawal	TCCA	TCCA Retarget	TCCA Withdrawal
040	Duplicate Telephone Number in Batch	There is a Telephone Number duplicated in a single Batch	√					√				
041	Multiple Sites	There are more than one site involved for the Telephone Numbers in a Batch	√									
042	Not Used											
043	Not Used											
044	Not Used											
045	Not Used											
046	Not Used											
047	Not Used											
048	Not Used											
049	Not Used											
050	Not Used											
051	Telephone Number currently being Ported to another C/CSP							√				
052	Service is currently connected to the ASD's network							√				

Reject Reason	LNP Reject Description	LNP Further Explanation	CNA	CNA Withdrawal	CCA	CCA Retarget	CCA Withdrawal	TCNA	TCNA Withdrawal	TCCA	TCCA Retarget	TCCA Withdrawal
053	Cutover Date is within the Lead Time											
054	Cutover Date is outside Expiry Date				√	√				√	√	
055	Invalid Status - CNA Retarget or Withdrawal requested after CCA was Confirmed			√					√			
056	Invalid Withdrawal Request			√			√		√			√
057	Invalid Retarget Request					√					√	
058	Not Used											
059	Not Used											
060	Incomplete Number Block or missing Telephone Numbers in Batch	Incomplete range / batch of service numbers in complex porting request	√									
061	Batch Reference Number Missing	Complex porting request received without batch number	√									
062	Giveback Date Invalid	Future dated										
063	Incorrect Category	Category listed in notification advice is incorrect	√									

Reject Reason	LNP Reject Description	LNP Further Explanation	CNA	CNA Withdrawal	CCA	CCA Retarget	CCA Withdrawal	TCNA	TCNA Withdrawal	TCCA	TCCA Retarget	TCCA Withdrawal
064	Secondary Reject	Porting request is valid for Telephone Number but is associated with a primary reject in the same complex batch	√									
065	Telephone Numbers are not contiguous for a product		√									
066	Not Used											
067	Invalid CA date	CA date is too old	√									
068	Not Used											
069	Donor reject	Incorrect Donor nominated						√				
070	Not Used											
071	Not Used											
072	Not Used											
073	Excluded product	Complex Service cannot be ported	√									
074	Not Used											
075	Not Used											
076	Not Used											
077	Batch Number NOT unique	Batch Number is being used for another active Port for the same Gaining C/CSP	√					√				

The policy objective of the greatest practicable use of industry self-regulation without imposing undue financial and administrative burdens on industry is central to the regulatory scheme of the *Telecommunications Act 1997*.

ACIF was established to implement the policy of industry self-regulation. It is a company limited by guarantee and is a not-for-profit membership-based organisation. Its membership comprises carriers/carriage service providers, business and residential consumer groups, industry associations and individual companies.

ACIF's mission is to develop collaborative industry outcomes that foster the effective and safe operation of competitive networks, the provision of innovative services and the protection of consumer interests. In the development of Industry Codes and Technical Standards as part of its mission, ACIF's processes are based upon its principles of openness, transparency, consensus, representation and consultation. Procedures have been designed to ensure that all sectors of Australian society are reasonably able to influence the development of Standards and Codes. Representative participation in the work of developing a Code or Standard is encouraged from relevant and interested parties. All draft Codes and Standards are also released for public comment prior to publication to ensure outputs reflect the needs and concerns of all stakeholders.



**Published by:
COMMUNICATIONS
ALLIANCE LTD**

**Level 9
32 Walker Street
North Sydney
NSW 2060 Australia**

**Correspondence
PO Box 444
Milsons Point
NSW 1565**

**T 61 2 9959 9111
F 61 2 9954 6136
TTY 61 2 9923 1911
E info@commsalliance.com.au
www.commsalliance.com.au
ABN 56 078 026 507**

Care should be taken to ensure the material used is from the current version of the Standard or Industry Code and that it is updated whenever the Standard or Code is amended or revised. The number and date of the Standard or Code should therefore be clearly identified. If in doubt please contact Communications Alliance